

R

Collection book

Rimadesio

Collection book

13 Wall paneling system

17 Modulor

45 Wall partition system

49 Spazio

67 Sliding doors

75 Daimon, 81 Sail, 89 Soho, 97 Velaria, 109 Stripe,  
117 Graphis plus, 129 Graphis light, 137 Siparium

145 Doors

149 Zen, Zen frame, 163 Sail, 171 Moon, 185 Luxor,  
193 Vela, 203 Aura, 209 Even, 215 Spin, 221 Link +

227 Storage system

231 Cover, 255 Cover freestanding

275 Day collection

279 Zenit, 287 Opus, 293 Wind, 303 Alambra,  
327 Self, 335 Self bold, 349 Self up, 363 Abacus living

375 Complements

379 Flat system, 389 Flat, 395 Long Island, 403 Manta,  
413 Planet, 419 Tray, 423 Sixty coffee table, 429 Sixty,  
433 Ala, 437 Dolmen, 441 Eos

447 Night collection

451 Dress bold, 467 Zenit, 479 Abacus

492 Finishings

Index

Fondata nel 1956, Rimadesio fa da sempre parte del tessuto industriale che identifica il distretto dell'arredamento della Brianza, a nord di Milano. Innovazione tecnologica, ricerca stilistica, coscienza ecologica sono i componenti di una propria,

Seit der Firmengründung im Jahr 1956, gehört Rimadesio zu den prägenden Industrieunternehmen des Einrichtungssektors der Brianzaregion nördlich von Mailand. Technologische Innovationen, stilistische Forschung, sowie Umweltbewusstsein sind

Crée en 1956, Rimadesio fait partie depuis toujours du tissu industriel qui identifie le district du meuble du Brianza, au nord de Milan. L'innovation technologique, la recherche de la conception, la conscience écologique sont les compo-

Fundada en 1956, Rimadesio es desde siempre parte del tejido industrial que identifica el distrito del amueblamiento en la Brianza, en el norte de Milán. Innovación tecnológica, investigación estilística, conciencia ecológica son los componentes

## The main used materials, glass and aluminium, represent a fundamental choice which is the base of the Rimadesio's identity.

esclusiva visione dell'italian design, tradotta in una proposta d'arredo e di suddivisione funzionale degli ambienti. Sistemi componibili per la zona giorno, librerie, porte scorrevoli, porte, cabine armadio e una sempre più ricca collezione di complementi: una concezione proget-

die Pfeiler des echten und exklusiven italienischen Designs. Die Umsetzung dieser Vision erfolgt in Einrichtungsvorschlägen und einer funktionellen Unterteilung der verschiedenen Wohnbereiche. Modulare Einrichtungssysteme für den Wohnbereich, darunter

santes de sa vision propre et unique du design italien, qui a donné lieu à une proposition de décoration et de séparation fonctionnelle des espaces. Les systèmes modulaires pour la zone jour, les bibliothèques, les panneaux coulissants, les portes battantes, les dressings et

de su propia exclusiva visión del design italiano, traducida en una propuesta de amueblamiento y división funcional de los ambientes. Sistemas modulares para la zona de día, bibliotecas, paneles correderos, puertas, vestidores y una colección cada vez mayor

La lavorazione del vetro Rimadesio prevede le tecnologie più aggiornate, come le apparecchiature computerizzate di taglio al laser. The manufacturing of the glass provides for the most updated technologies, such as the electronical machinery with laser cut.



tuale nata dalla collaborazione con Giuseppe Bavuso, designer di riferimento dell'azienda, che si traduce in soluzioni concrete per l'abitare contemporaneo, dagli ambiti domestici agli spazi professionali, fino alle grandi forniture. Definita da una interpretazione fortemente architettonica dell'arredo,

Bücherregale, Schiebetüranlagen, Zimmertüren, Schrank- und Ankleidesysteme, sowie eine immer breiter werdende Auswahl an Zubehör, sind das Ergebnis der Zusammenarbeit mit Giuseppe Bavuso, Referenz-Designer des Unternehmens, die sich in konkrete Lösungen für die Wohngestaltung

une collection de plus en plus riche d'accessoires; un concept développé en collaboration avec Giuseppe Bavuso, designer de référence de la société, ce qui se traduit par des solutions concrètes pour la décoration contemporaine, des environnements domestiques aux espaces professionnels, en passant par

de complementos: un concepto de diseño desarrollado en colaboración con Giuseppe Bavuso, diseñado de referencia de la empresa, que se traduce en soluciones concretas para la vida contemporánea, de los entornos domésticos a los espacios profesionales, hasta los grandes suministros. Definita por una



Founded in 1956, Rimadesio has always been part of the industrial furniture district of Brianza, north of Milan. Technological innovation, design research, environmental awareness are parts of its exclusive vision of the Italian design, resulting in furniture projects and functional partition of spaces. Modular systems for the living room, bookcases, sliding panels, swing doors, walk-in closets and a wider collection of complements: a design concept born from the partnership with Giuseppe Bavuso, the company designer, that results in concrete solutions for the contemporary living, ranging from domestic spaces to professional settings and big projects. Defined by a highly architectural interpretation of furniture,

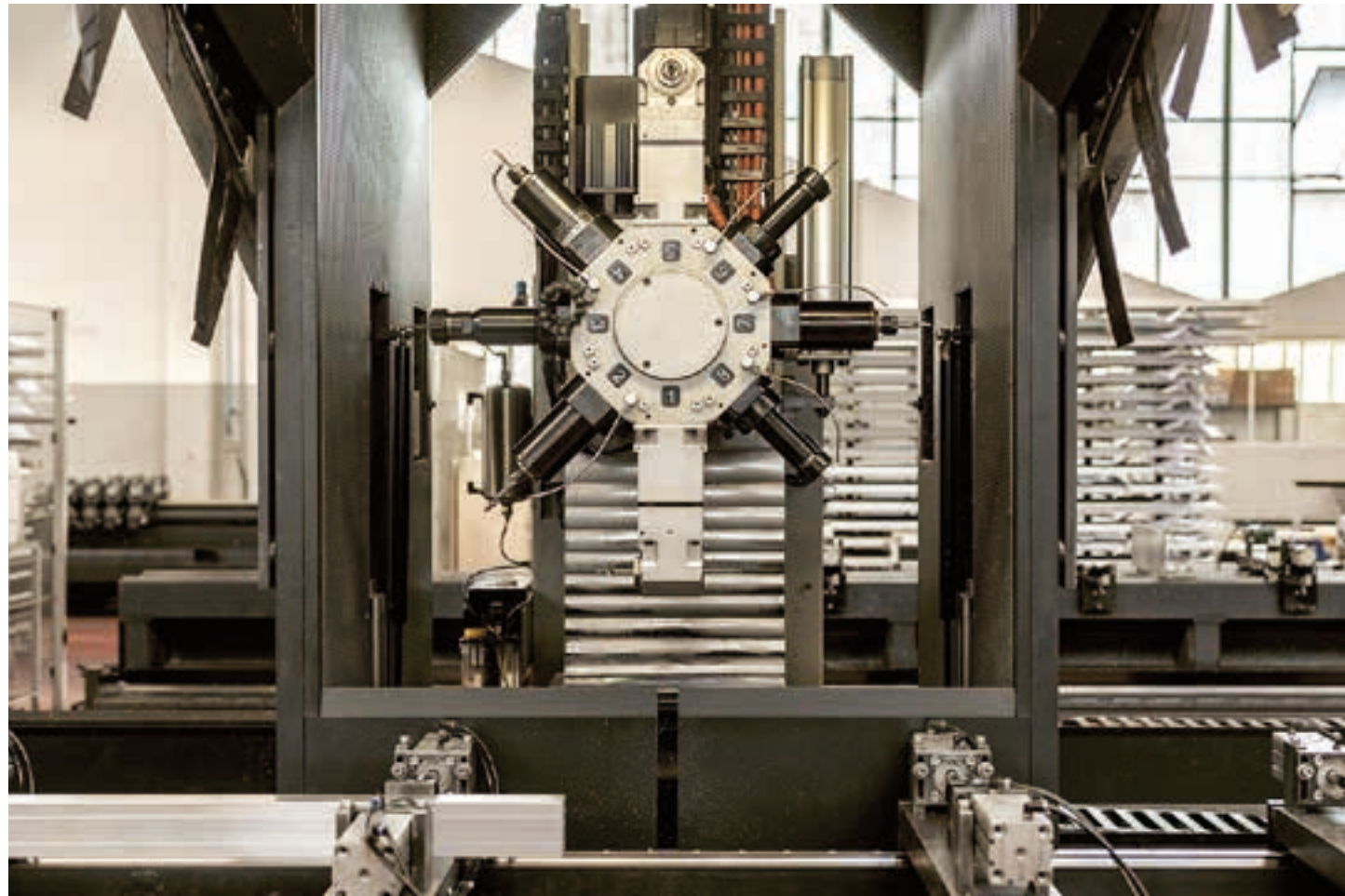

la proposta si distingue per uno stile preciso e inconfondibile, in equilibrio tra rigore delle forme e combinazioni uniche tra materiali e finiture esclusive. Il vetro e l'alluminio, materiali caratteristici della collezione Rimadesio, sono infatti declinati in svariati trattamenti cromatici e superficiali, risultato di ricerca e sperimentazione continue.

Un vantaggio reso possibile da una gestione interna di tutte le fasi di lavorazione che permette di garantire il controllo e l'affidabilità totale di uniformità e precisione del manufatto. Una condizione fondamentale per una realtà ad alta componente tecnologica, in cui ogni progetto, in prevalenza custom-made, comporta lavorazioni sofisticate e affiancate da una importante presenza di meccanismi, binari di scorrimento, cerniere e sistemi di illuminazione, esclusivi e brevettati.

Ma la vocazione all'innovazione si esprime anche nella

umsetzen lassen und zwar vom häuslichen Umfeld über Arbeitsräume, bis hin zu Großraumausstattungen. Diese stark von der Architektur geprägten Planungsentwürfe zeichnen sich durch einen präzisen und unverkennbaren Stil, sowie durch eine einmalige Kombination von Materialien und exklusiven Feinbearbeitungen aus. Glas und Aluminium, die charakteristischen Materialien der Rimadesio Kollektion, stehen in vielen Farben und Oberflächen zur Auswahl und sind das Ergebnis kontinuierlicher Forschung und der Probe verschiedener Kombinationsmöglichkeiten.

Dieser Vorteil ergibt sich aus der Verlagerung sämtlicher Arbeitsgänge in die eigene Fabrik, wodurch die Kontrolle und die totale Zuverlässigkeit der Einheitlichkeit und Präzision des Produktes garantiert werden können. Letzteres ist einer der Grundbedingungen für ein

les grand projets. Défini par une forte interprétation architecturale des meubles, la proposition se caractérise par un style précis et sans équivoque, un équilibre entre la rigueur des formes et des combinaisons uniques de matériaux et de finitions exclusives. Le verre et l'aluminium, des matériaux caractéristiques de la collection Rimadesio, sont en fait utilisés dans divers traitements de couleur et de surface, comme résultat de la recherche et de l'expérimentation continue.

La gestion interne de toutes les étapes de traitement permet d'assurer le contrôle et la fiabilité totale de l'uniformité et de la précision des produits. Une condition fondamentale d'une réalité avec une forte composante technologique, dans laquelle chaque projet, qui est presque toujours sur mesure, implique des processus sophistiqués et qui comprennent des mécanismes, des rails de coulissements, des charnières et des

fuerte interpretación arquitectónica del amueblamiento, la propuesta se caracteriza por un estilo preciso e inequívoco, en equilibrio entre el rigor de las formas y las combinaciones únicas de materiales y acabados exclusivos. El cristal y el aluminio, materiales característicos de la colección Rimadesio, son de hecho declinados en distintos tratamientos cromáticos y de superficie, resultado de investigación y experimentación continuas.

Una ventaja posible gracias a una gestión interna de todas las etapas de procesamiento que permite asegurar el control y la fiabilidad total de la uniformidad y precisión del producto. Una condición fundamental para una realidad con alto componente tecnológico, en el que cada proyecto, sobre todo custom-made, implica procesos sofisticados y acompañados por una importante presencia de mecanismos, guías correderas,

the collection stands out for a precise and unmistakable style, in balance between shapes' precision and unique match of materials and exclusive finishings. Glass and aluminium, main materials of the Rimadesio Collection, go under different chromatic and exterior processes, result of continuous research and tests.

An advantage made possible by an internal management of every production phase, which allows to guarantee control and total reliability of the product's uniformity and precision. An essential condition for a highly technological company, where every project, mostly custom-made, involves advanced processes,

Le collezioni prevedono oltre 70 finiture di vetri diversi per trasparenza, opacità, riflessione e colore. Il sistema Ecolorsystem, una proposta esclusiva Rimadesio, prevede solo vernici all'acqua. The collections provides for more than 70 different glasses in transparency, opacity, reflection and colour. The Ecolorsystem, an exclusive Rimadesio proposal, provides only water based paintings.



together with exclusive and patented mechanisms, sliding rails, hinges and lighting systems.

But the vocation to innovation also speaks through the continuous research of solutions aimed at improving the qualitative environmental standards. Purpose achieved through the combined use of aluminium and glass, Rimadesio peculiar materials, totally recyclable, treated with advanced painting technologies, without harmful

ricerca continua di soluzioni volte a migliorare i propri standard qualitativi ambientali. Obiettivo ottenuto sinergicamente grazie all'utilizzo di alluminio e vetro, materiali caratteristici di Rimadesio, totalmente riciclabili, trattati con tecnologie di verniciatura all'avanguardia, prive di sostanze nocive e gestiti nella fase finale con sistemi di

Produkt, das hoch technologisch und maßgeschneidert ist, da es mit kompliziert feinen Verarbeitungen, exklusiv patentierten Mechanismen für Laufschienen, Schmieren und Beleuchtungssystemen gefertigt ist.

Die Bereitschaft zur Innovation drückt sich auch in den ständigen Bemühungen zur Verbesserung der Umweltver-

systemes d'éclairage, exclusifs et brevetés.

Mais la vocation à l'innovation est également exprimé dans la recherche continue de solutions pour améliorer les normes de qualité environnementale.

Cet objectif est bien obtenu grâce à l'utilisation de l'aluminium et du verre, entièrement recyclables, traités avec des tech-

bisagras y sistemas de iluminación, exclusivos y patentados.

Pero la vocación a la innovación se expresa también en la búsqueda continua de soluciones para mejorar sus estándares cualitativos ambientales.

Objetivos obtenidos sinérgicamente a través del uso del aluminio y cristal, materiales característicos de Rimadesio,

## Innovation as essential constant. Technology as an opportunity to improve the quality of the environment where the man lives.

imballaggio ecologici dal ridotto impatto ambientale.

Al centro del processo produttivo un sistema ad alto standard tecnologico, interamente alimentato con energia

träglichkeit aus. Dieses Ziel wird durch die Verwendung von den recycelbaren Materialien wie Aluminium und Glas, mit einer modernen schadstoffarmen Lackierungstechnologie

nologies de laquage avancées, sans substances nocives, et dans la phase finale exploitent des systèmes d'emballage écologiques avec un impact réduit sur l'environnement.

totalmente riciclabili, trattati con tecnologie di pittura avanzata, libere di sostanze nocive e gestite nella fase finale con sistemi di imballaggio ecologici con minor impatto ambientale.

Rimadesio utilizza esclusivamente imballi riciclabili, prodotti just in time, corrispondenti al fabbisogno giornaliero. I sistemi di gestione sono completamente automatizzati. Rimadesio uses exclusively recyclable packagings, produced just in time, matching the daily requirement. The managing systems are completely automated.



pulita proveniente da impianti fotovoltaici di ultima generazione, 5250 pannelli installati sulla copertura dell'headquarter di Giussano in grado di assicurare la produzione di 1300 kWh. Un impegno non comune sul fronte dell'ecosostenibilità, con continui investimenti volti al potenziamento e all'aggiornamento tecnologico che è valso a Rimadesio una serie di significativi primati. Tra questi, quello di prima azienda in Europa

und durch ein umweltfreundliches Verpackungssystem erreicht. Die Produktionsanlagen von Rimadesio in Giussano werden durch moderne Photovoltaikanlagen betrieben. 5250 Photovoltaik Paneele ermöglichen eine Produktion von 1300kWh. Rimadesio hat für diese außergewöhnliche Bemühung für den Umweltschutz, welche mit ständigen Investitionen verbunden ist, bereits zahlreiche Auszeichnungen

Au centre de la production, un système avec un haut standard technologique, entièrement alimenté en énergie propre provenant de la dernière génération de systèmes photovoltaïques, avec 5250 panneaux installés sur le toit de l'usine de Giussano, assure la production de 1300 kWh. Un engagement peu commun en termes d'écologie, avec des investissements continus, dont l'objectif est de renforcer et de mettre à jour les nouvelles

En el centro del proceso de producción un sistema de alto estándar tecnológico, impulsado en su totalidad con energía limpia a partir de sistemas fotovoltaicos de última generación, 5250 paneles instalados en el Headquarter de Giussano capaz de asegurar la producción de 1.300 kWh. Un compromiso que no es común en términos de sostenibilidad del medio ambiente, con continuas inversiones dirigidas a reforzar



substances and dealt in the final phase with ecological packaging systems aimed at reducing the effect on the environment.

At the center of the production process there is a highly technological system, fully powered by solar energy, coming from innovative photovoltaic plants, with 5250 panels installed on the Giussano headquarter's roof, that ensure the production of 1300 kWh. An uncommon commitment to an ecological culture, with continuous investments on development and technological update that allowed Rimadesio to reach important records. Among them, Rimadesio as the first industrial company in Europe to provide itself with a storage plant on a large scale, connected with a new system of lithium batteries able to store the energy surplus, in order to further

a dotarsi di un impianto di storage su larga scala a livello industriale, legato ad un nuovo sistema di batterie al litio in grado di immagazzinare l'energia prodotta in eccesso, così da migliorare ulteriormente il processo virtuoso. Testimonianze concrete di un DNA green consolidato, espresso in ogni fase del processo produttivo, basato sulla convinzione di voler affidare

erhalten. Eine davon zählt Rimadesio zu einer der ersten Firmen in Europa, welche über eine Speichereinheit aus Lithiumakkumulatoren verfügt, die das Speichern von Mehrere Energie auf industriell relevantem Niveau ermöglicht.

Seine Stärke verdankt Rimadesio seiner präzisen und kohärenten Identität, das es zu einem globalen "waschech-

technologies, qui ont permis à Rimadesio un grand nombre de premières importantes. Parmi ceux-ci, la première entreprise en Europe à adopter un système de stockage à grande échelle à un niveau industriel, lié à un nouveau système de batterie au lithium capable de stocker l'énergie produite en excès, afin d'améliorer encore le processus vertueux. Témoignage

y actualizar a la nueva tecnología que le valió a Rimadesio una serie de significativos hitos. Entre estos, la primera empresa en Europa para adoptar un sistema de storage a gran escala a nivel industrial, atado a un nuevo sistema de batería de litio capaz de almacenar la energía producida en exceso, a fin de mejorar aún más el proceso virtuoso. Testimonios concretos

## The Rimadesio production plants are entirely powered by solar energy. In 2011, the company has achieved an important goal: zero emissions of CO<sub>2</sub>.

all'uomo solo attività dall'alto valore aggiunto.

Forte di una identità precisa e coerente, oggi Rimadesio è una realtà 100% made in Italy con una vocazione decisamente internazionale, confermata dalla presenza in 90 paesi nel mondo con punti vendita monomarca nelle principali città.

ten" italienischen Spieler gemacht hat, was durch seine Präsenz in 90 verschiedenen Ländern dieser Erde und Monobrand-Showrooms in allen wichtigen Metropolen nochmals bekräftigt wird.

d'un ADN vert, exprimé dans toutes les phases de la production, basée sur la conviction que l'homme ne devait intervenir que dans les activités à forte valeur ajoutée.

Avec une identité précise, cohérente, aujourd'hui Rimadesio est une réalité 100% made in Italie avec une vocation des plus en plus internationale, confirmée par la présence dans 90 pays dans le monde, avec des magasins mono-marque dans les métropoles les plus importantes.

de un ADN green consolidado, expresado en cada fase de la producción, basado en la convicción de querer confiar al hombre sólo en las actividades de alto valor añadido.

Con una identidad precisa y coherente, hoy Rimadesio es una realidad 100% made in Italy con una vocación sin duda internacional, confirmada por la presencia en 90 países de todo el mundo, con tiendas monomarca en las principales ciudades.

La stazione di ricarica gestisce l'energia prodotta dall'impianto fotovoltaico e rientra in un programma di conversione in alimentazione 100% elettrica e ibrida dei mezzi di trasporto aziendali. The charging station manages the energy produced by the photovoltaic system and is part of a project of conversion to 100% electric and hybrid power supply of the company's vehicles.



improve the virtuous process. Tangible proof of a solid green DNA, in every phase of the production process, based on the certainty to entrust men only high added value's activities.

With a precise and coherent identity, Rimadesio is today a 100% made in Italy company with a strong international vocation, confirmed by the brand presence in 90 world countries with monobrand showrooms in the main cities.

# Wall paneling system







design Giuseppe Bavuso

## Modulor

A system of equipped wall paneling system, a new solution in order to qualify, equip and customize the surfaces of domestic and work environments. Always custom-made, flexible to any architectural situation, Modulor allows to create organized or composite geometries, to freely position shelves, cabinets or display cases, and to choose from a wide variety of materials and exclusive finishes.

Un sistema di boiserie attrezzate, una nuova soluzione per qualificare, attrezzare e personalizzare le superfici degli ambienti domestici e di lavoro. Sempre su misura, adattabile ad ogni situazione architettonica, Modulor permette di creare geometrie ordinate o composte, di posizionare in libertà mensole, contenitori o vetrine, di scegliere tra un'ampia varietà di materiali e finiture esclusive.

Ein Wandverkleidungssystem mit Ausstattung, eine neue Lösung, um private Wohnräume und Arbeitsplätze aufzuwerten, auszustatten und zu personalisieren. Immer auf Maß gefertigt, anpassbar an jede architektonische Anforderung, erlaubt Modulor, geordnete geometrische Kompositionen zu planen und darin relativ frei Bänke, Hängeelemente und Vitrinen zu positionieren. Das System bietet eine reiche Auswahl an exklusiven Materialien und Oberflächen.

Un système de boiserie équipées, une nouvelle solution pour qualifier, équiper et personnaliser les surfaces de l'environnement domestique et professionnel. Toujours personnalisé, adaptable à chaque situation architecturale, Modulor permet de créer géométries organisées et composées, de positionner librement les étagères, les contenants ou les vitrines, de choisir entre une grande variété de matériaux et finitions exclusives.

Un sistema de boiserie equipadas, una nueva solución para calificar, equipar y personalizar las superficies de los ambientes de hogar y trabajo. Siempre a medida, adaptable a cada situación arquitectónica, Modulor permite crear geometrías ordenadas y compuestas, colocar libremente estantes, contenedores o vitrinas, elegir entre una amplia variedad de materiales e acabados exclusivos.

Nella foto *In this photo*  
 Vettrine pensili *Suspended cabinets*: Alambra  
 Tavoli *Tables*: Manta  
 Porte scorrevoli *Sliding doors*: Sail  
 Tavolino *Coffee table*: Tray

Struttura *Structure*: 304 platino  
 Rivestimento *Cladding*: G001 gres crema



Struttura *Structure*: 304 platino  
Rivestimento *Cladding*: G001 gres crema

Struttura *Structure*: 304 platino  
Rivestimento *Cladding*: 154 simipelle argilla  
Maniglia con inserto in tinta al pannello  
*Handle with insert matching the panel*

Nella foto *In this photo*  
Tavolo *Table*: Long Island  
Sistema interparete  
*Wall partition system*: Spazio  
Porte scorrevoli *Sliding doors*: Sail



Modulor è un sistema boiserie di nuova concezione. Una superficie pura, scandita da profili strutturali orizzontali e verticali su cui si innestano contenitori interamente in vetro, mensole dallo spessore sottilissimo e vetrine orizzontali o verticali. I pannelli sono dotati di illuminazione led dimmabile nella parte superiore ed inferiore.

Modulor is a new concept wall paneling system. A plain surface, emphasized by horizontal and vertical structural profiles, on which glass cabinets, shelves of very thin thickness and horizontal or vertical display cases are fixed. The panels are equipped with dimmable LED lighting on the upper and lower part.

Modulor ist ein neues Konzept für ein Boiserie-System. Es handelt sich um eine reine Oberfläche, die von horizontalen und vertikalen Strukturprofilen unterteilt ist, auf die vollständig aus Glas hergestellte Behälter gepropft werden und die mit sehr dünnen Dielen und horizontalen oder vertikalen Fachböden bestückt wird. Die Paneele sind oben und unten mit einer dimmbaren LED-Beleuchtung ausgestattet.

Modulor est un nouveau système de boiserie. Une surface pure, ponctuée de profils structurels horizontaux et verticaux, sur lesquels sont fixés des conteneurs entièrement en verre, des étagères d'épaisseur très fine et des vitrines horizontales ou verticales. Les panneaux sont équipés d'un éclairage LED dimmable en haut et en bas.

Modulor es un nuevo concepto de sistema boiserie. Una superficie pura, marcada por perfiles estructurales horizontales y verticales en los que se injertan contenedores hechos completamente de cristal, estantes de grosor muy fino y vitrinas horizontales o verticales. Los paneles están equipados con iluminación LED dimmable en la parte superior e inferior.



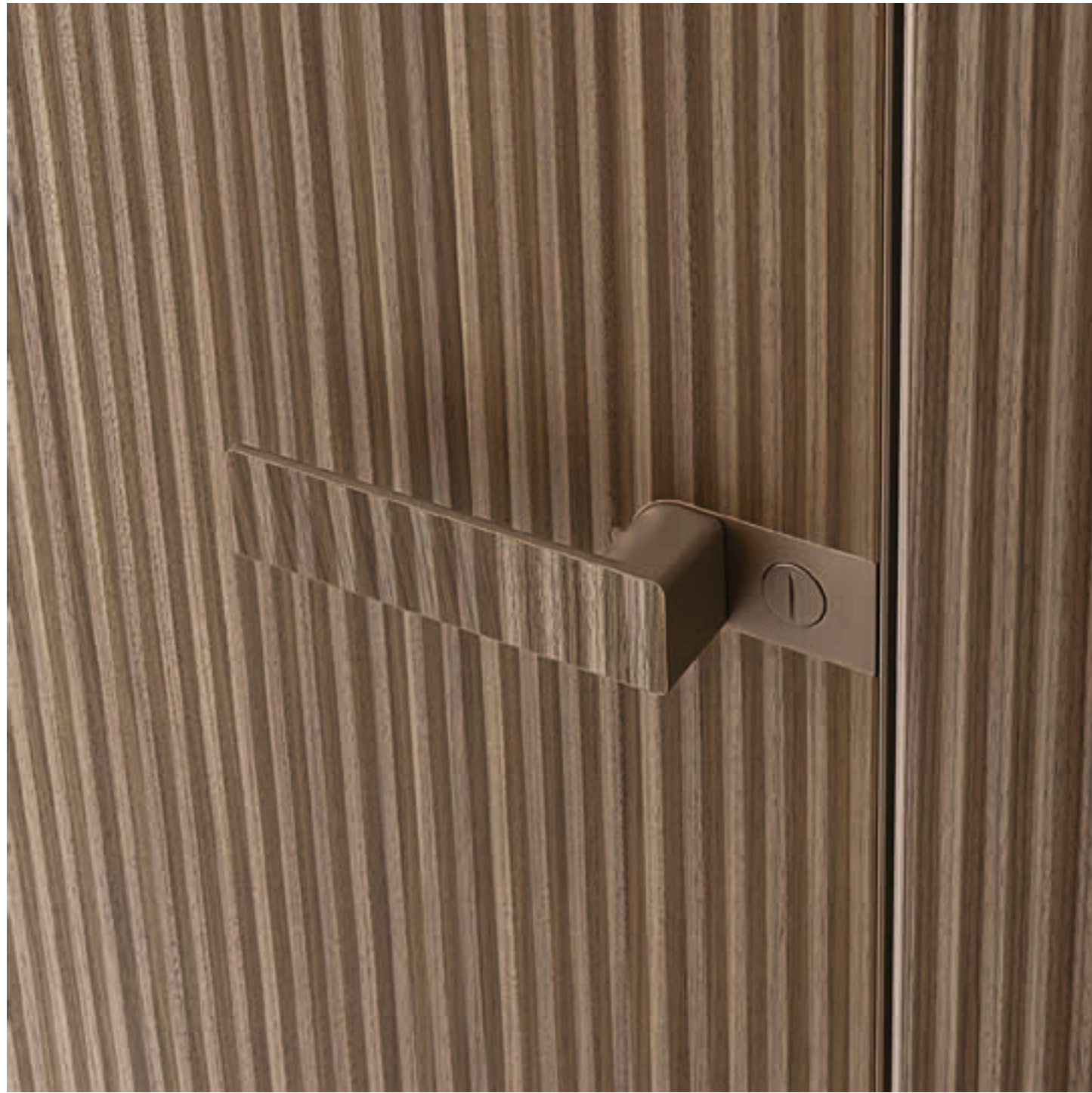



Elementi base del progetto Modulator, i pannelli sono disponibili in quattro larghezze (320, 640, 960, 1280mm) e consentono di progettare in totale libertà grazie alla modularità a passo 320mm. La realizzazione della boiserie, sempre su misura, è consentita fino all'altezza massima di 3894mm e alla larghezza massima di 1280mm per pannello. I traversi orizzontali, posizionabili a piacere a passo 160mm, assicurano infinite possibilità estetiche e massima qualità funzionale.

Key elements of the Modulator project, the panels are available in four widths (320, 640, 960, 1280 mm) and allow to design in total freedom, thanks to the modularity with a distance of 320mm. The realization of the always custom made wall panelling is available up to the maximum height of 3894mm and to the maximum width of 1280mm per panel. The horizontal structural profiles, which can be positioned, as desired, following a distance of 160mm, allows endless aesthetic possibilities and maximum functional quality.

Diese Paneele sind in vier Breiten (320, 640, 960, 1280mm) erhältlich und erlauben eine totale freie Planung, dies dank der Modularität von 320mm Schritt. Die Herstellung der Wandverkleidung, welche immer nach Mass erfolgt, ist bis zu einer maximalen Höhe von 3894mm, und einer maximalen Breite von 1280mm zulässig. Die Horizontalen Traversen haben einen definierten Abstand von 160mm und können frei positioniert werden, dies ermöglicht eine unendliche, ästhetische und funktionale Möglichkeit.

Éléments de base du projet Modulator, les panneaux sont disponibles en quatre largeurs (320, 640, 960, 1280mm) et permettent de faire un projet en toute liberté, grâce à sa modularité avec pas de 320mm. La réalisation de la boiserie, toujours sur mesure, est disponible jusqu'à une hauteur maximale de 3894mm et une largeur maximale de 1280mm par panneau. Les profils structurels horizontales, qui peuvent être positionnées avec une distance de 160mm, garantissent des possibilités esthétiques infinies et une qualité fonctionnelle maximale.

Elementos básicos del proyecto Modulator, los paneles están disponibles en cuatro anchos (320, 640, 960, 1280mm) y permiten diseñar con total libertad gracias a la modularidad con un paso de 320mm. La realización de la boiserie, siempre hecha a medida, está permitida hasta la altura máxima de 3894mm y hasta el ancho máximo de 1280mm por panel. Los perfiles estructurales horizontales, posicionables al gusto con un paso de 160mm, garantizan infinitas posibilidades estéticas y la máxima calidad funcional.









L'estetica minimal e ricercata della boiserie Modulator nasconde al suo interno una solida struttura in alluminio estruso, frutto della ricerca tecnologica Rimadesio, sulla quale si innestano i contenitori sospesi della collezione Self o Alambra.

The minimal and refined aesthetics of the Modulator wall paneling conceal a solid structure in extruded aluminum, as a result of Rimadesio technological research, on which the suspended Self or Alambra cabinets are fixed.

Die minimale und ausgewählt Ästhetik der Wandverkleidung Modulator, verbirgt im Inneren eine solide Struktur aus Stangengepresstem Aluminium. In dieser Struktur können die Möbel Self und Alambra eingefügt und dadurch abgehängt werden.

L'esthétique minimale et raffinée de la boiserie Modulator va cacher une structure solide en aluminium extrudé, résultat de la recherche technologique de Rimadesio, sur laquelle les éléments suspendus de la collection Self ou Alambra sont fixés.

La estética minimalista y refinada de la boiserie Modulator oculta en su interior una estructura sólida en aluminio extruido, resultado de la investigación tecnológica de Rimadesio, en que se injertan los contenedores suspendidos de la colección Self o Alambra.





## Il pannello The panel

Modularità  
Modular structure

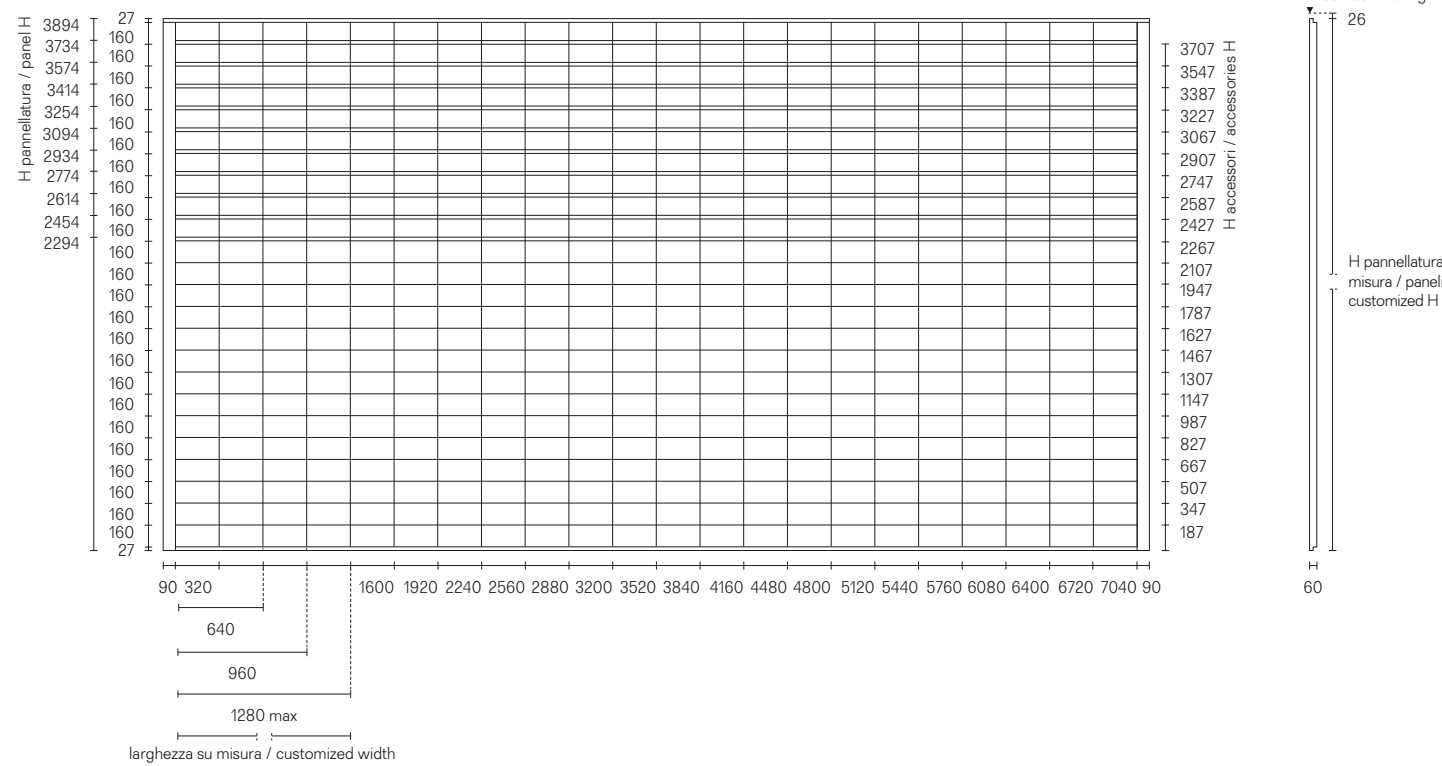

### Descrizione tecnica Technical description

I pannelli sono disponibili in quattro larghezze (320, 640, 960, 1280mm) e consentono di progettare in totale libertà grazie alla modularità a passo 320mm. La realizzazione della boiserie, sempre su misura, è consentita fino all'altezza massima di 3894mm.

The panels are available in four widths (320, 640, 960, 1280 mm) and allow to design in total freedom, thanks to the modularity with a distance of 320mm. The realization of the always custom made wall panelling is available up to the maximum height of 3894mm.

Diese Paneele sind in vier Breiten (320, 640, 960, 1280mm) erhältlich und erlauben eine totale freie Planung, dies dank der Modularität von 320mm Schritt. Die Herstellung der Wandverkleidung, welche immer nach Mass erfolgt, ist bis zu einer maximalen Höhe von 3894mm.

Les panneaux sont disponibles en quatre largeurs (320, 640, 960, 1280mm) et permettent de faire un projet en toute liberté, grâce à sa modularité avec pas de 320mm. La réalisation de la boiserie, toujours sur mesure, est disponible jusqu'à une hauteur maximale de 3894mm.

Los paneles están disponibles en cuatro anchos (320, 640, 960, 1280mm) y permiten diseñar con total libertad gracias a la modularidad con un paso de 320mm. La realización de la boiserie, siempre hecha a medida, está permitida hasta la altura máxima de 3894mm.

Pannello in gres o vetro  
Panel in glass or gres

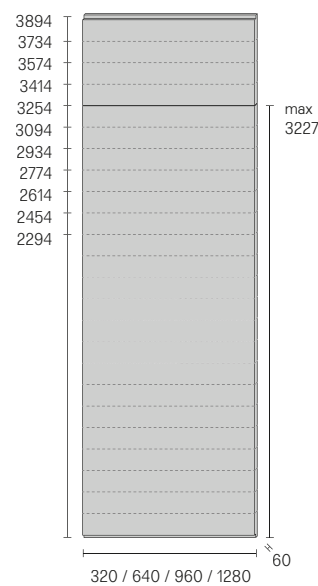

Pannello in essenza  
Panel in wood

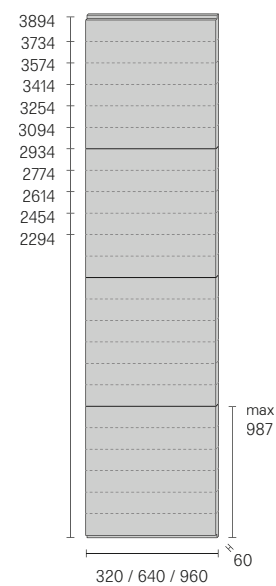

Pannello in similpelle o tessuto  
Panel in synthetic leather or fabric

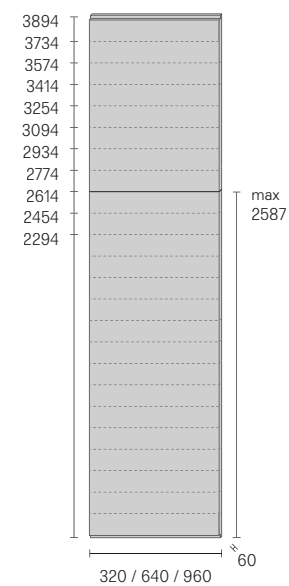

## Esempi di tipologie estetiche H 2614 Examples of aesthetic typologies H 2614

Pannello senza traversi  
Panel without pattern lines

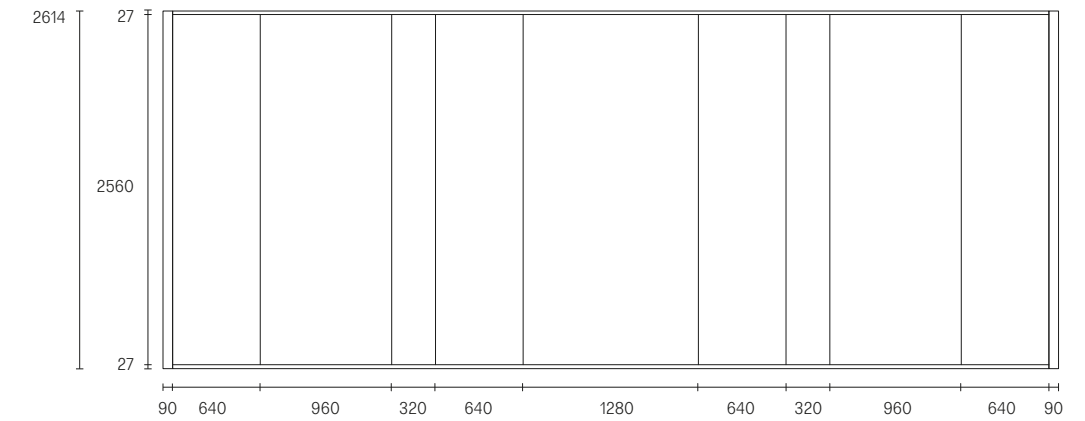
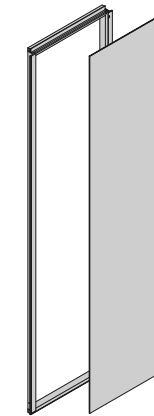

Pannello attrezzabile a maglia quadrata  
Squared pattern panel to be equipped

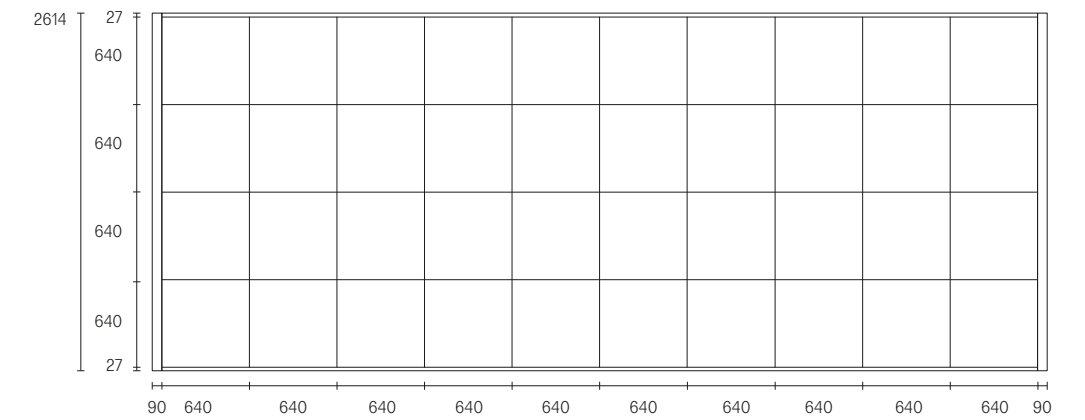
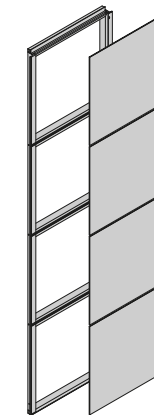

Pannello attrezzabile a maglia irregolare  
Irregular pattern panel to be equipped

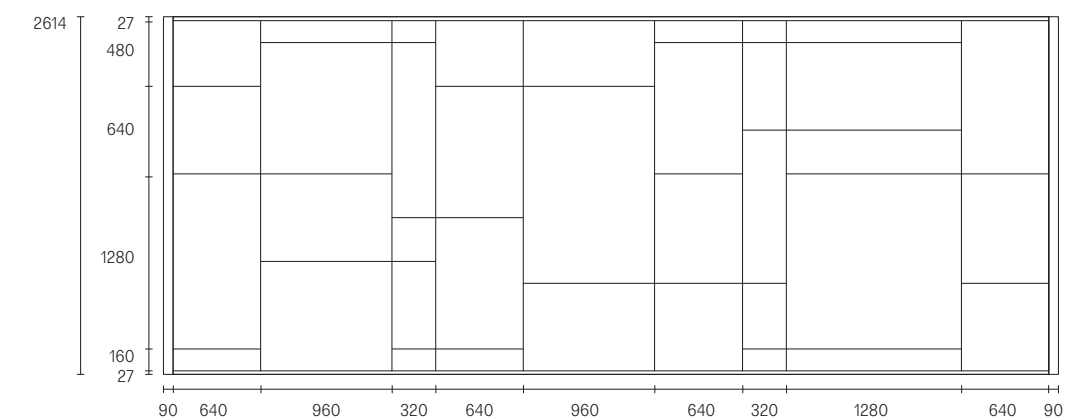
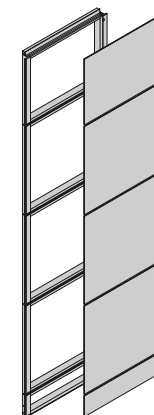

**Pannello fisso**  
Fixed panel

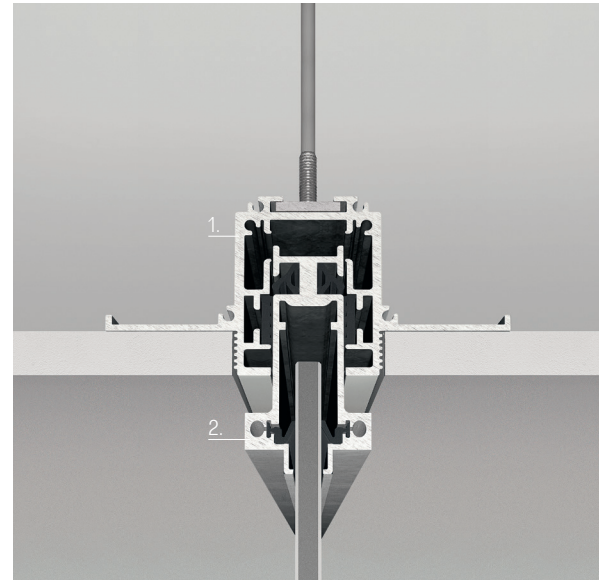

A

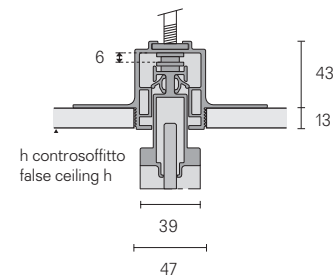

**Porta battente**  
Swing door

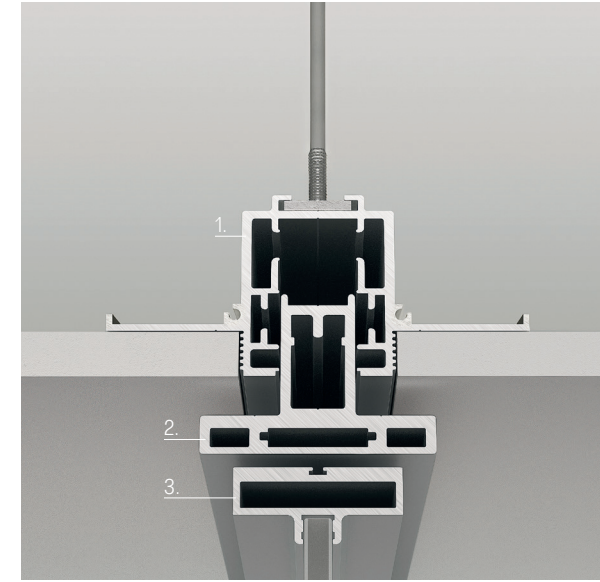

B

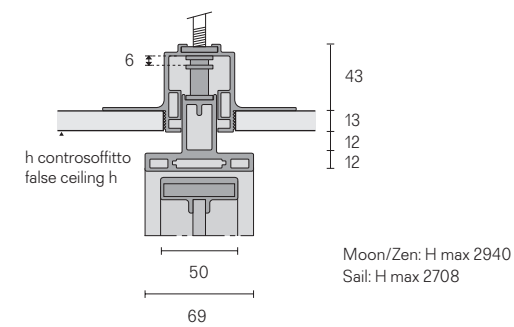

Porte battenti abbinare al sistema interparete Spazio  
Swing doors combined with Spazio wall partition system

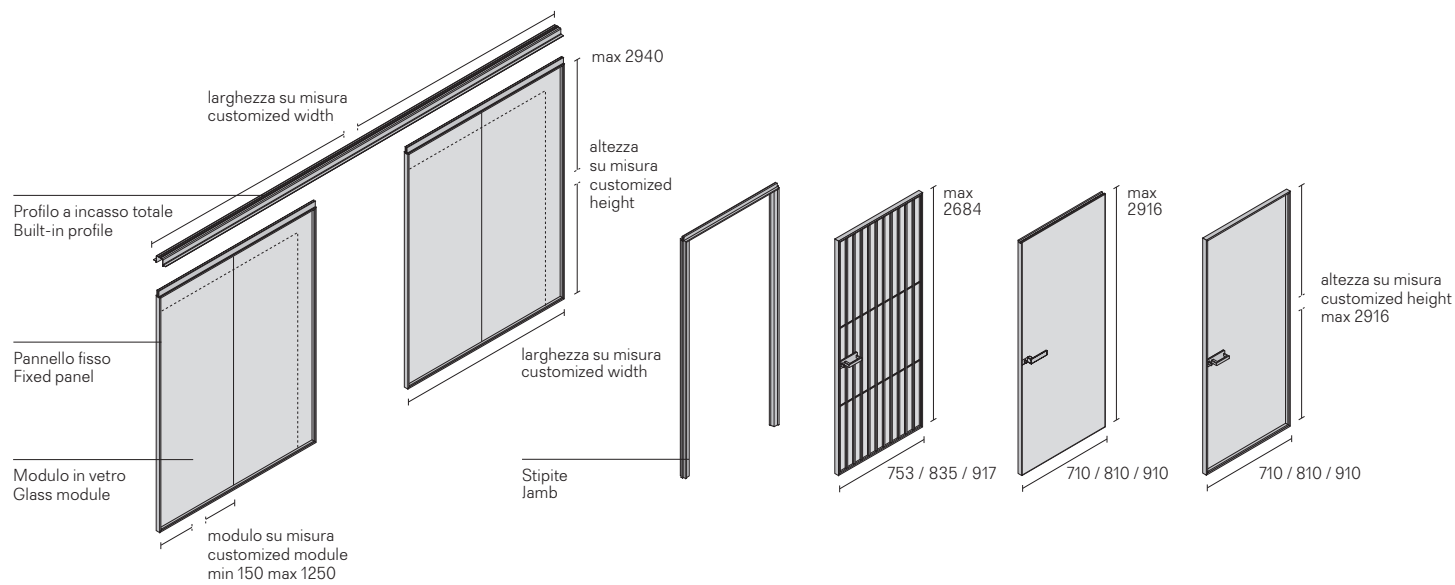

**Pannello fisso e porta scorrevole**  
Fixed panel and sliding door

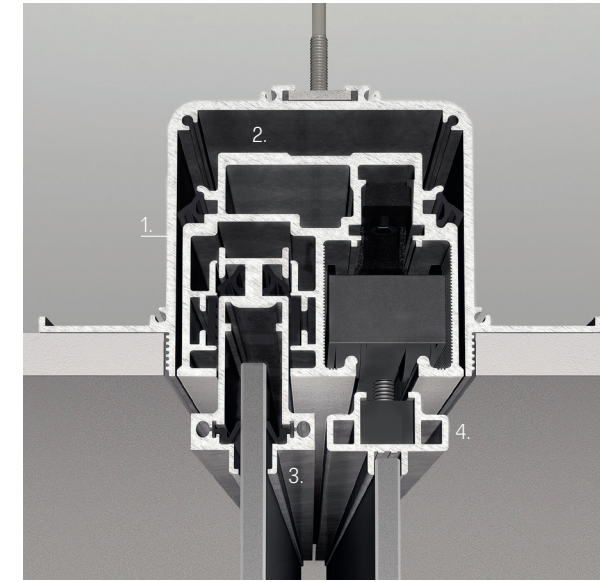

C

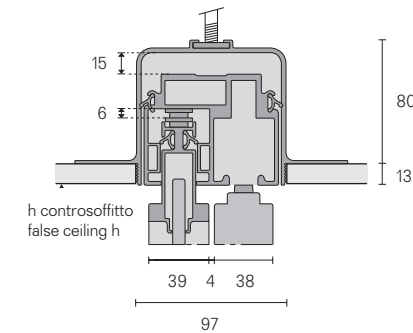

Porte scorrevoli abbinare al sistema interparete Spazio  
Sliding doors combined with Spazio wall partition system

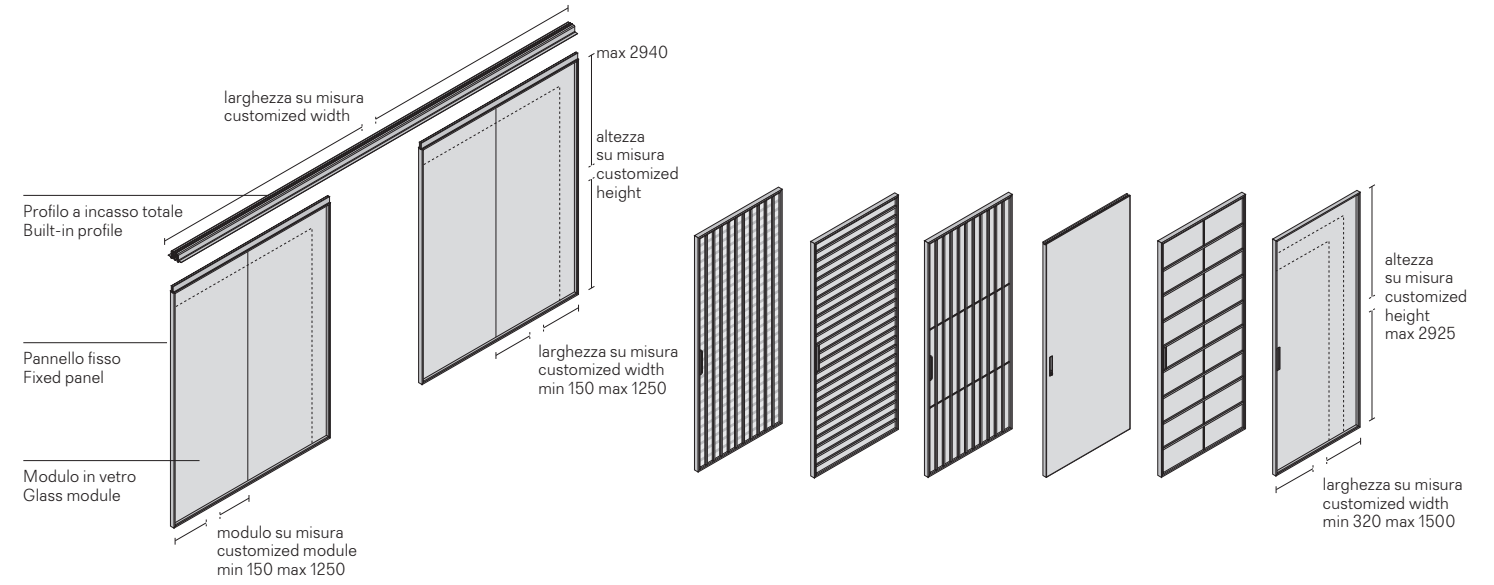

A. Il profilo in alluminio ad incasso totale (1) consente la perfetta messa in bolla del telaio superiore (2) con una regolazione di 6 mm.  
The aluminum built in profile (1) allows the perfect leveling of the upper frame (2) with a 6 mm adjustment.

B. Il profilo in alluminio ad incasso totale (1) consente la perfetta messa in bolla dello stipite (2) con una regolazione di 6 mm.  
Le porte battenti sono disponibili con apertura a tirare o a spingere (3).  
The fully recessed aluminum profile (1) allows the perfect leveling of the jamb (2) with an adjustment of 6 mm.  
Swing doors are available with push or pull opening (3).

C. Il profilo ad incasso totale (1) consente la perfetta messa in bolla del binario di scorrimento (2) con una regolazione di 15 mm.  
Il telaio superiore (3) è dotato a sua volta di una propria regolazione di 6 mm per l'allineamento con le porte scorrevoli (4).  
Le porte scorrevoli adottano il nuovo e collaudato meccanismo di scorrimento Rimadesio dotato di regolazione micrometrica in altezza.  
The built in profile (1) allows a perfect leveling of the sliding rail (2) with an adjustment of 15 mm.  
The upper frame (3) is equipped with its own 6 mm adjustment to be aligned with the sliding doors (4).  
The sliding doors are provided with the new and tested Rimadesio sliding mechanism with micrometric height adjustment.

## Possibilità di utilizzo Application possibilities

Modulor è un sistema boiserie polifunzionale, liberamente componibile e adattabile alle diverse esigenze architettoniche del settore residenziale, contract e retail. Scandito da un design essenziale, Modulor integra molteplici varianti: può essere configurato con attrezzature sospese, combinarsi con porte a tirare, a spingere e passaggi. Permette inoltre di rivestire a effetto continuo le pareti di un intero ambiente.

Modulor is a multi-purpose modular wall paneling system flexible to the different architectural needs of the residential, contract and retail projects. Emphasized by an essential design, Modulor integrates multiple possibilities: it can be equipped with suspended units, combined with pull or push opening swing doors and opening passages. It also allows to completely cover the walls of a whole room.

Modulor ist ein multifunktionales Boiserie-System, das frei modular aufgebaut und an die unterschiedlichen architektonischen Anforderungen von Wohn-, Objekt- und Einzelhandelsbereichen angepasst werden kann. Das Modulor ist mit einem wesentlichen Design versehen und integriert mehrere Varianten: Es kann mit aufgehängten Geräten konfiguriert werden, kombiniert mit Zug-, Druck- und Durchgängen. Außerdem können die Wände eines gesamten Raums kontinuierlich bedeckt werden.

Modulor est un système de boiserie polyvalent, modulable et adaptable aux différents besoins architecturaux des secteurs résidentiel, contract et de la vente au détail. Souligné par un design essentiel, Modulor intègre plusieurs variantes: il peut être équipé avec des éléments suspendus, combinés avec des ouvertures passages port, de portes battantes avec ouverture à pousser et à tirer. Il permet également de couvrir les murs de toute une chambre de manière continue.

Modulor es un sistema de boiserie multifuncional, libremente modular y adaptable a las diferentes necesidades arquitectónicas de los sectores residencial, contract y retail. Escaneado por un diseño esencial, Modulor integra múltiples variantes: puede configurarse con accesorios colgantes, combinarse con puertas de paso a tirar o empujar y aperturas con puente superior. También permite cubrir con efecto continuo las paredes de un ambiente completo.

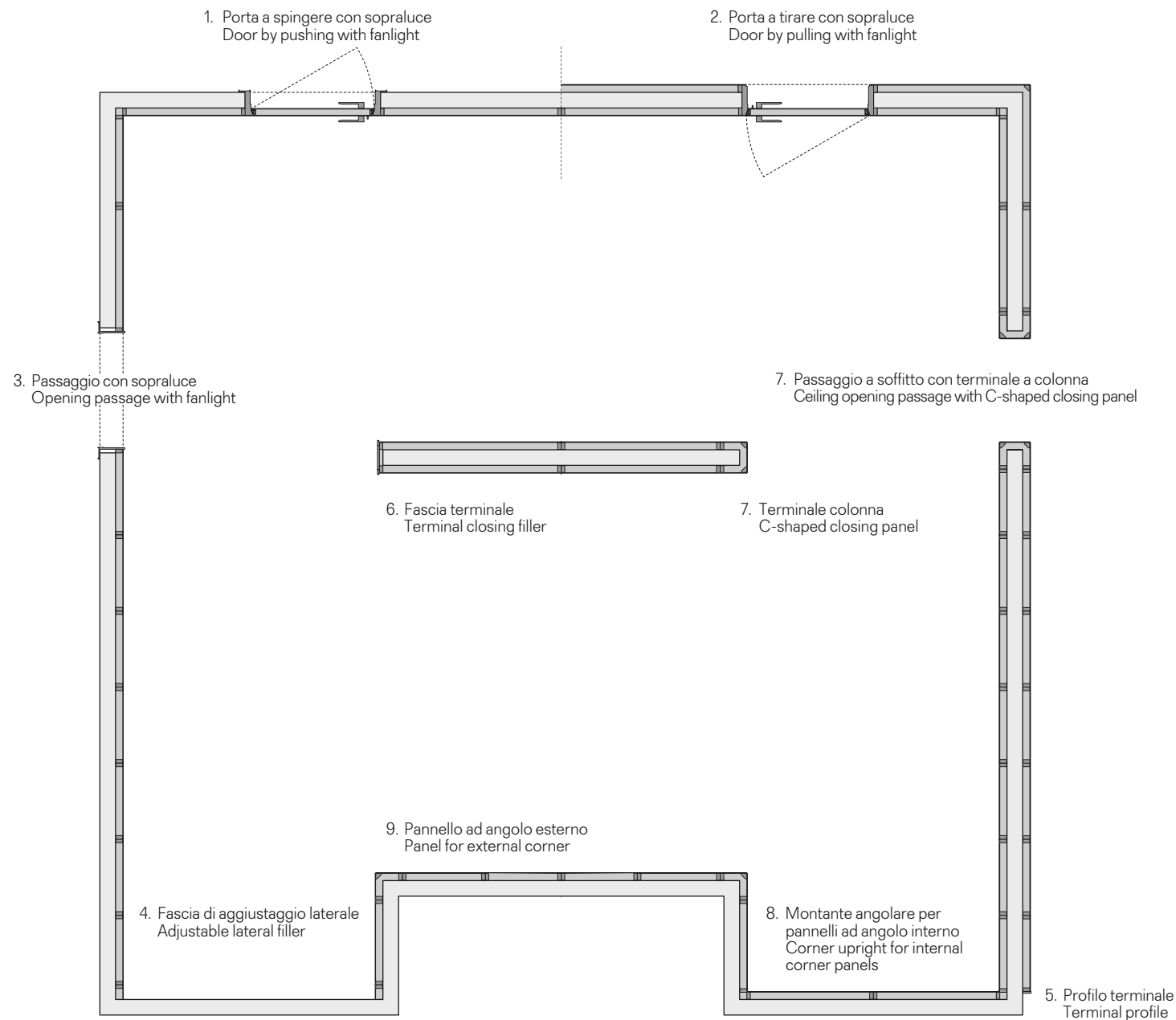

### 1. Porta a spingere con sopraluce Door by pushing with fanlight

\*per boiserie monofacciale/for one-sided wall paneling min 85 max 495  
\*per boiserie bifacciale/for double sided wall paneling min 90 max 465

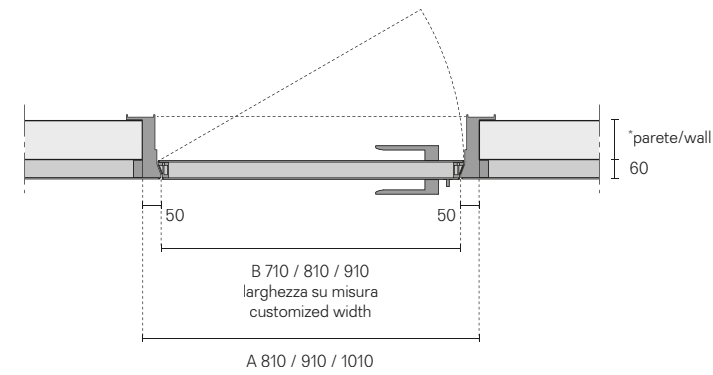

### 2. Porta a tirare con sopraluce Door by pulling with fanlight

\*per boiserie monofacciale/for one-sided wall paneling min 80 max 495  
\*per boiserie bifacciale/for double sided wall paneling min 85 max 465

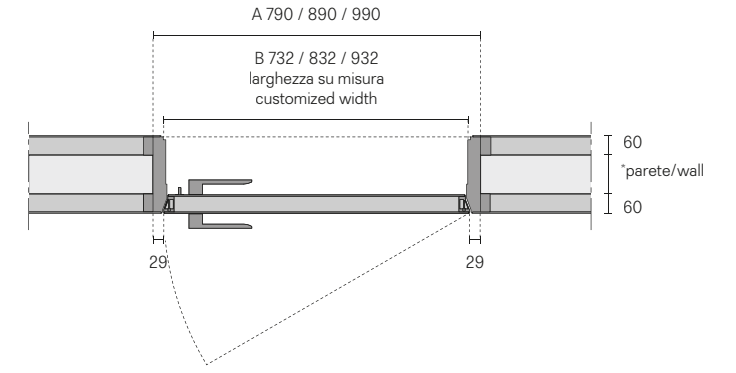

### 3. Passaggio con sopraluce Opening passage with fanlight

\*per boiserie monofacciale/for one-sided wall paneling min 35 max 445  
\*per boiserie bifacciale/for double sided wall paneling min 70 max 415

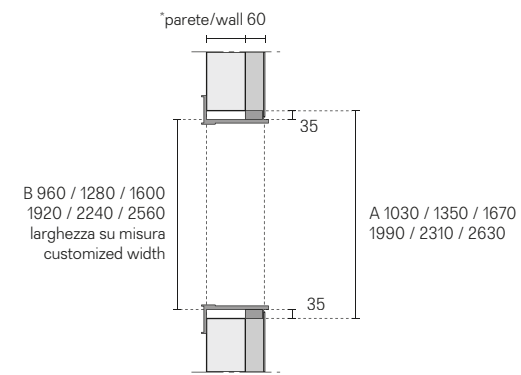

### 4. Fascia di aggiustaggio laterale Adjustable lateral filler

### 5. Profilo terminale Terminal profile

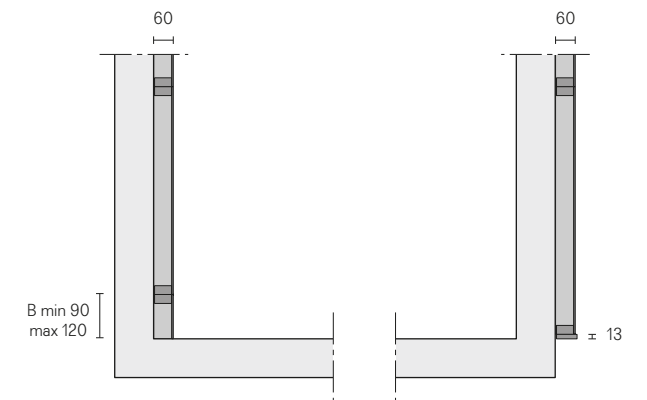

### 6. Fascia terminale Terminal closing filler

\*per boiserie monofacciale/for one-sided wall paneling min 35 max 445  
\*per boiserie bifacciale/for double sided wall paneling min 70 max 415

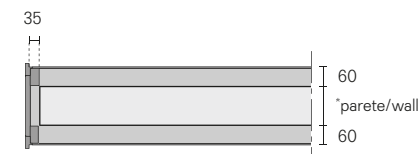

### 7. Terminale per pannello o colonna C-shaped closing panel

\*per boiserie bifacciale/for double sided wall paneling min 70 max 520

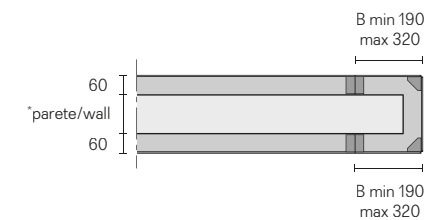

### 8. Montante angolare per pannelli ad angolo interno Corner upright for internal corner panels

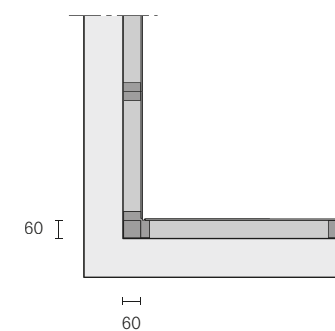

### 9. Pannello ad angolo esterno Panel for external corner

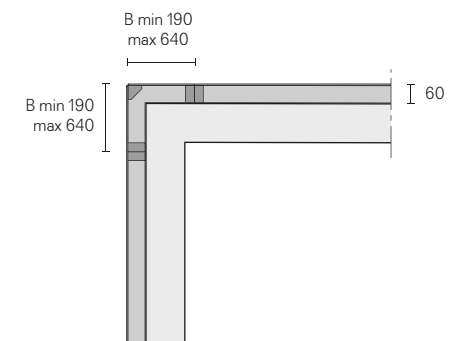

A. Falso telaio / Subframe  
B. Interasse / Center distance

# Wall partition system







Design Giuseppe Bavuso

## Spazio

Glass wall partition system, always custom made, providing linear, corner and terminal solutions for the internal organization of domestic, public, or professional environments. Spazio's design versatility is underlined by the free combination with sliding doors and Moon, Sail and Zen swing doors. Endless solutions to combine the finishes of glass and aluminum with structural elements.

Sistema interparete in vetro, sempre su misura, che prevede soluzioni lineari, angolari e terminali per l'organizzazione interna di ambienti domestici, pubblici o professionali. La versatilità progettuale di Spazio è sottolineata dalla libera combinazione con le ante scorrevoli e le porte battente Moon, Sail e Zen. Infinite le soluzioni di abbinamento tra le finiture dei vetri e dell'alluminio degli elementi strutturali.

Maßgeschneidertes Raumteiler System aus Glas, das lineare, eckige und endständige Lösungen für die interne Organisation von häuslichen, öffentlichen oder beruflichen Umgebungen bietet. Die Vielseitigkeit des Spazio wird durch die freie Kombination mit Schiebetüren und Drehtüren Moon, Sail und Zen unterstrichen. Es gibt zahlreiche Lösungen, um die Oberflächen von Glas und Aluminium mit Strukturelementen zu kombinieren.

Système de cloison fixe en verre, toujours sur mesure, qui fournit des solutions linéaires, angulaires et terminales pour l'organisation interne des environnements domestiques, publics ou professionnels. La polyvalence de conception de Spazio est souligné par les nombreuses combinaisons de portes coulissantes et de portes battantes Moon, Sail et Zen. Des solutions infinies pour combiner les finitions du verre et de l'aluminium avec les éléments structurels.

Sistema de vidrio entre paredes, siempre a medida, que proporciona soluciones lineales, angulares y terminales para la organización interna de ambientes domésticos, públicos o profesionales. La versatilidad de diseño de Spazio está subrayada por la combinación libre de puertas correderas y puertas batientes Moon, Sail y Zen. Infinitas son las soluciones para combinar los acabados de vidrio y aluminio con elementos estructurales.

Tutti i vetri temprati e stratificati previsti per l'interparete Spazio sono conformi alle normative UNI EN 12150, UNI 7696, UNI EN 12600, UNI EN ISO 12543 e disponibili in versione trasparente, rete e satinati per un totale di diciassette finiture.

Every tempered or laminated glass are compliance with UNI EN 12150, UNI 7595, UNI EN 12600, UNI EN ISO 12543 standards, they are available in the transparent, rete and satinated versions for a total of seventeen finishes.

Alle gehärteten und beschichteten Gläser, die für den Raumteiler Spazio vorgesehen sind, sind mit den Normen UNI EN 12150, UNI 7696, UNI EN 12600, UNI EN ISO 12543 konform und in der durchsichtigen, Netz- und Satinversion in insgesamt neunzehn Ausführungen erhältlich. Alle Deckenbefestigungen sind in derselben Farbe der Decke vorgesehen.

Tous les verres trempés et stratifiés fournis pour le système de cloison fixe Spazio sont conformes aux normes UNI EN 12150, UNI 7696, UNI EN 12600, UNI EN ISO 12543 et disponibles en versions transparentes, en maille et satinées pour un total de dix-sept finitions.

Todos los vidrios templados y estratificados proporcionados para el sistema entre paredes Spazio cumplen con las normas UNI EN 12150, UNI 7696, UNI EN 12600, UNI EN ISO 12543 y están disponibles en versiones transparentes, rete y satinados para un total de diecisiete acabados.





L'interparete Spazio e le porte scorrevoli vengono sempre realizzate su misura in altezza e larghezza. L'altezza massima del controsoffitto non può essere superiore a 2940 mm. Il profilo ad incasso a soffitto ed il sistema di fissaggio a parete e a pavimento sono dotati di regolazione telescopica per la messa in bolla e per compensare le imperfezioni di verticalità e planarità degli ambienti.

Spazio wall partition system and the sliding doors are always custom-made both in height and width. The maximum ceiling height cannot exceed 2940 mm. The built in ceiling profile and the wall and floor fixing systems are equipped with telescopic adjustment for levelling and compensating any imperfection of verticality and planarity of the rooms

Die Zwischenwand Spazio und die Schiebetüren werden immer in Bezug auf Höhe und Breite maßgefertigt. Die maximale Deckenhöhe darf 2940 mm nicht überschreiten. Das Deckeneinbauprofil und das Wand- und Bodenbefestigungssystem sind mit einer Teleskopverstellung zum Nivellieren und zum Ausgleich von Unebenheiten der Vertikalität und Ebenheit der Räume ausgestattet.

Le système de cloison fixe Spazio et les panneaux coulissants sont toujours réalisés sur mesure en hauteur et en largeur. La hauteur maximale du plafond ne peut pas dépasser 2940 mm. Le pré-rail encastré au plafond et le système de fixation au mur et au sol sont équipés d'un réglage télescopique pour le nivellement et pour compenser les imperfections de la verticalité et de la planéité des environnements.

El sistema entre paredes Spazio y las puertas correderas siempre a medida en altura y ancho. La altura máxima del techo no puede exceder los 2940 mm. El perfil embutido al techo y el sistema de fijación a pared y suelo están equipados con ajuste telescópico para nivelación y para compensar las imperfecciones de verticalidad y planitud de las habitaciones.





Il profilo a soffitto ad incasso totale è predisposto per la verniciatura in loco in tinta al soffitto. Tutti i profili in alluminio che compongono il telaio Spazio sono disponibili in alluminio, nero, bianco latte, brown e nelle 34 tinte della gamma Ecolorsystem.

The built in ceiling profile is designed for on site painting to match the ceiling. All aluminum profiles, composing the Spazio frame, are available in anodized aluminium, black, bianco latte, brown and in the 34 colors of the Ecolorsystem range.

Das gesamte Deckeneinbauprofil ist für die vor Ort Lackierung in der Deckenfarbe vorgesehen. Alle Aluminiumbefestigungen, die den Spazio Rahmen bilden, sind in aluminium, nero, bianco latte, brown und in den vierunddreißig Farben des Ecolorsystem-Sortiments erhältlich.

Le pré rail encastré au plafond est disponible pour être peint sur place. Tous les profils en aluminium qui composent le cadre Spazio sont disponibles en aluminium, noir, bianco latte, brown et dans les 34 couleurs de la gamme ecolorsystem.

El perfil embutido está diseñado para ser pintado en obra en el mismo acabado que el techo. Todos los perfiles de aluminio que componen Spazio están disponibles en aluminio, negro, bianco latte, brown y en los 34 colores de la gama de ecolorsystems.

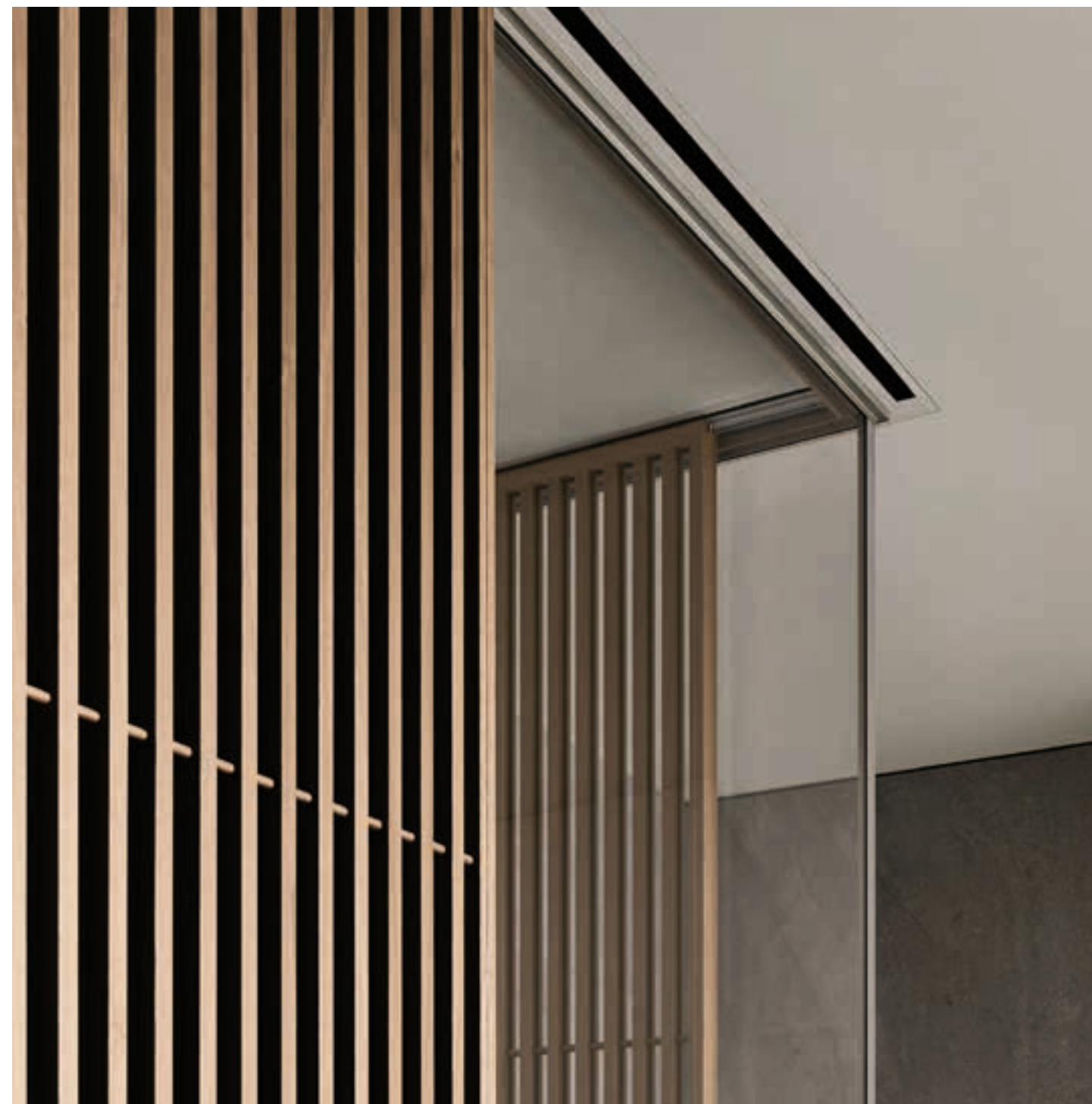







**Pannello fisso**  
Fixed panel

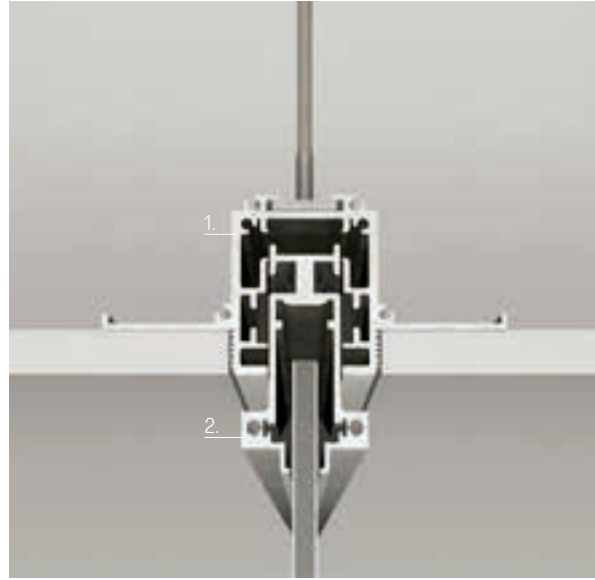

A

**Porta battente**  
Swing door

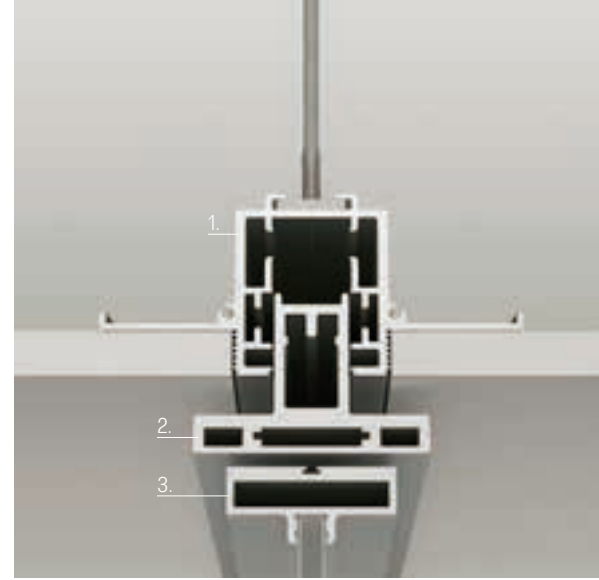

B

**Pannello fisso e porta scorrevole**  
Fixed panel and sliding door

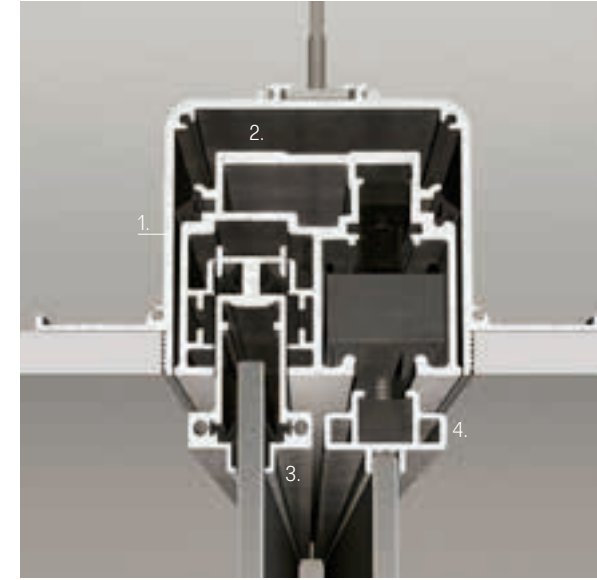

C

- A. Il profilo in alluminio ad incasso totale (1) consente la perfetta messa in bolla del telaio superiore (2) con una regolazione di 6 mm. The aluminum built in profile (1) allows the perfect leveling of the upper frame (2) with a 6 mm adjustment.
- B. Il profilo in alluminio ad incasso totale (1) consente la perfetta messa in bolla dello stipite (2) con una regolazione di 6 mm. Le porte battenti sono disponibili con apertura a tirare o a spingere (3). The fully recessed aluminum profile (1) allows the perfect leveling of the jamb (2) with an adjustment of 6 mm. Swing doors are available with push or pull opening (3).
- C. Il profilo ad incasso totale (1) consente la perfetta messa in bolla del binario di scorrimento (2) con una regolazione di 15 mm. Il telaio superiore (3) è dotato a sua volta di una propria regolazione di 6 mm per l'allineamento con le porte scorrevoli (4). Le porte scorrevoli adottano il nuovo e collaudato meccanismo di scorrimento Rimadesio dotato di regolazione micrometrica in altezza. The built in profile (1) allows a perfect leveling of the sliding rail (2) with an adjustment of 15 mm. The upper frame (3) is equipped with its own 6 mm adjustment to be aligned with the sliding doors (4). The sliding doors are provided with the new and tested Rimadesio sliding mechanism with micrometric height adjustment.

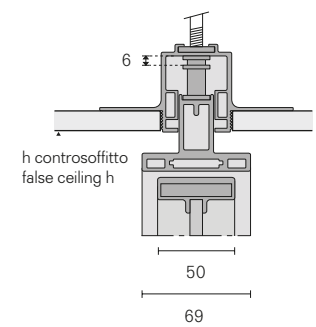
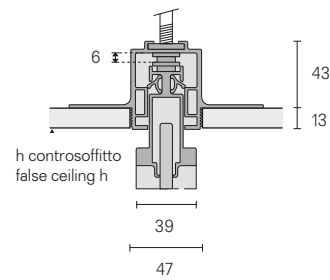

Moon/Zen: H max 2940  
Sail: H max 2708

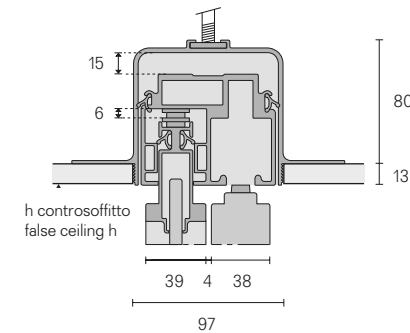

Porte battenti abbinare al sistema interparete Spazio  
Swing doors combined with Spazio wall partition system

Sail Moon Zen

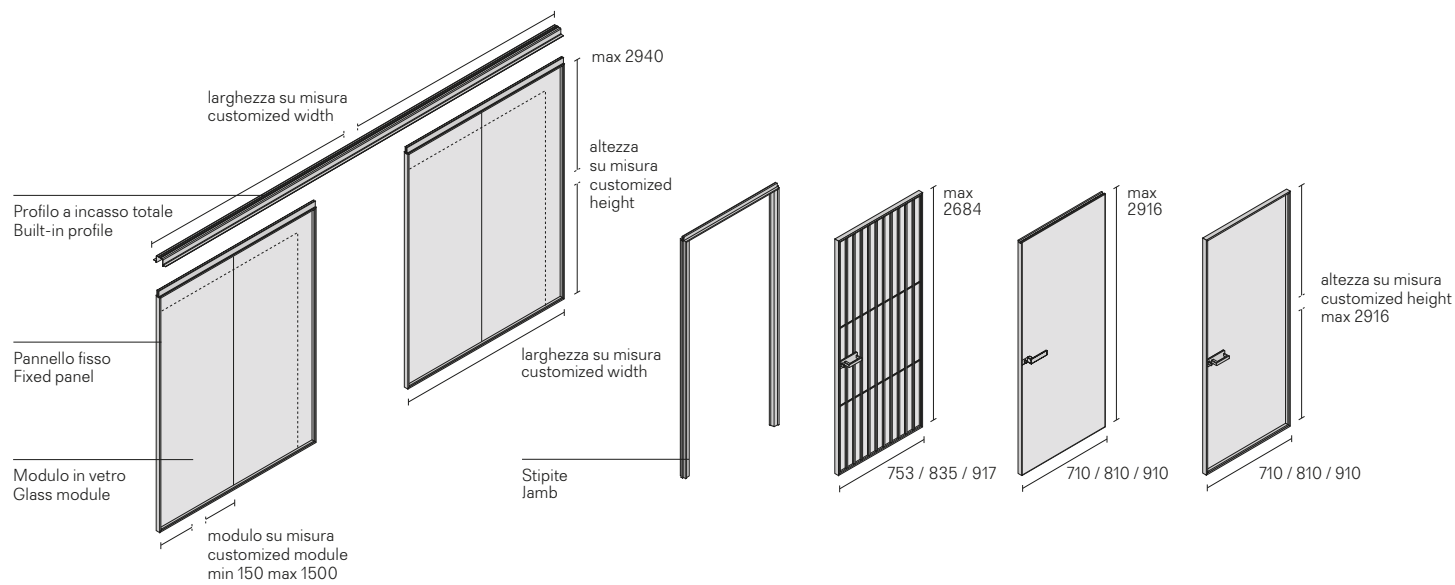

Porte scorrevoli abbinare al sistema interparete Spazio  
Sliding doors combined with Spazio wall partition system

Daimon Stripe Sail Graphis plus Soho Velaria

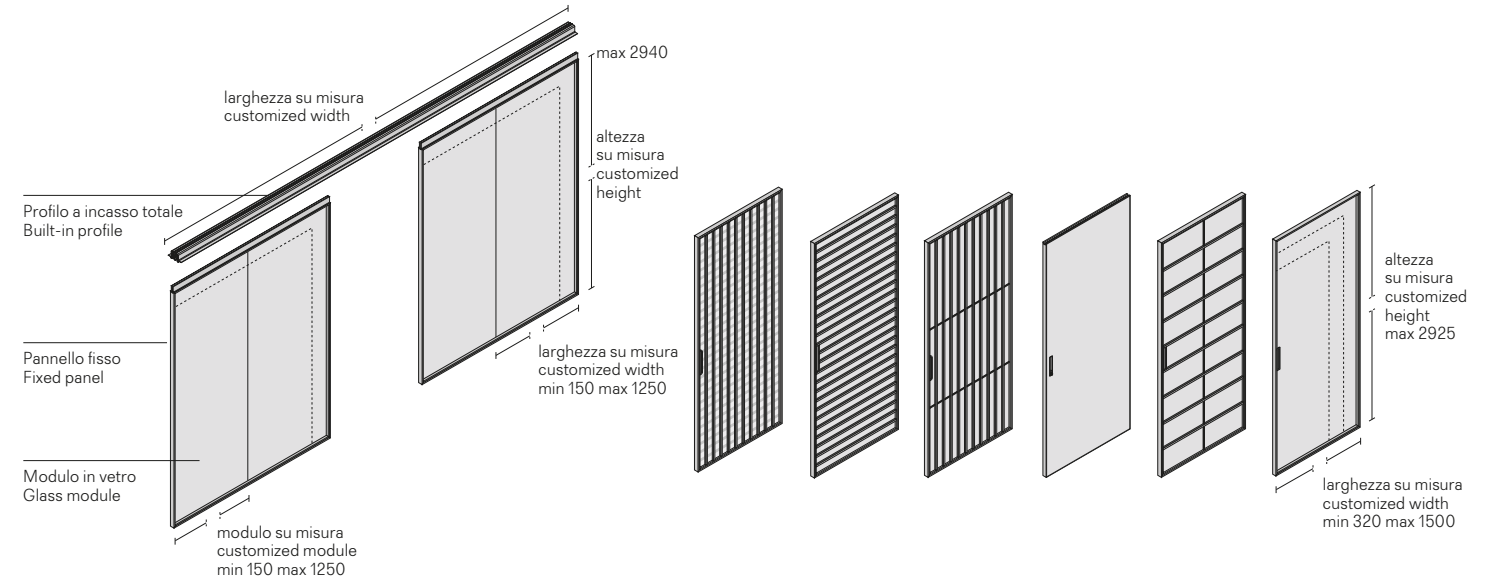

# Sliding doors

75 Daimon, 81 Sail, 89 Soho, 97 Velaria, 109 Stripe,  
117 Graphis plus, 129 Graphis light, 137 Siparium

## Binari di scorrimento brevettati Patented sliding rails

### Binario a soffitto Ceiling rail

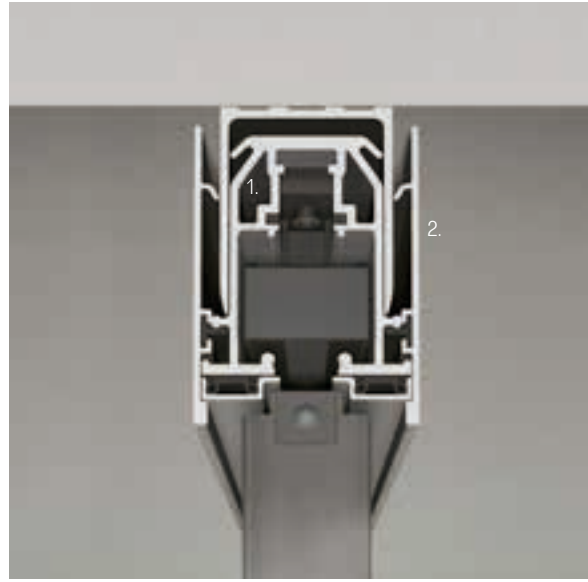

Monorotaia  
Single rail

Birotaia  
Double rail

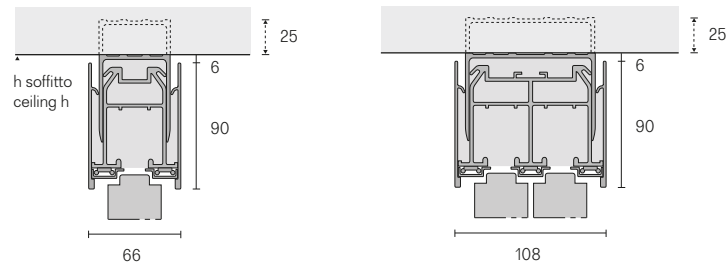

Trirotaia  
Three ways rail

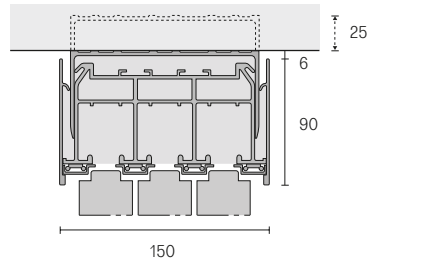

Quadrirotaia  
Four ways rail

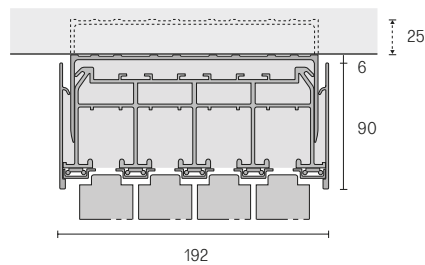

### Binario ad incasso Built-in rail

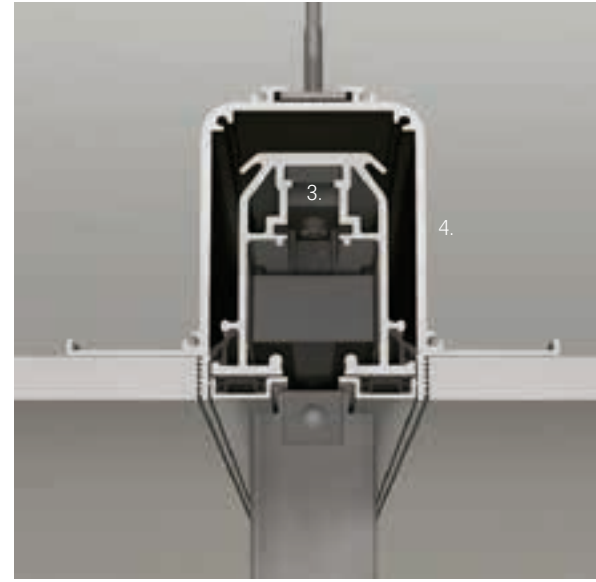

Monorotaia  
Single rail

Birotaia  
Double rail

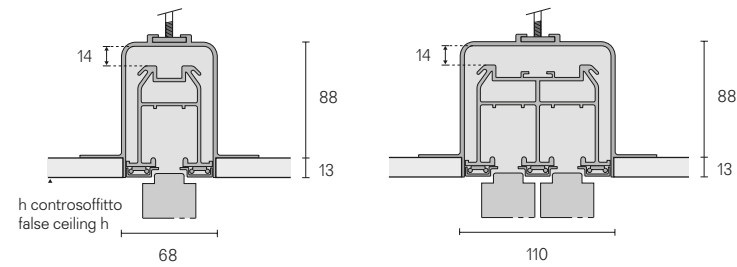

Trirotaia  
Three ways rail

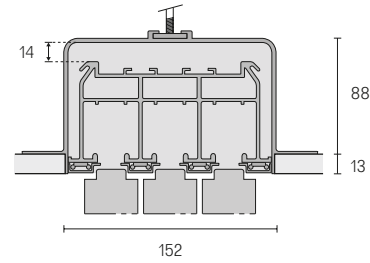

Quadrirotaia  
Four ways rail

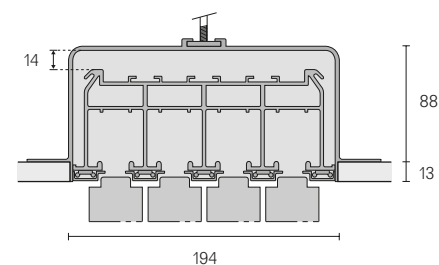

### Binario a parete Wall rail



Monorotaia  
Single rail

Birotaia  
Double rail

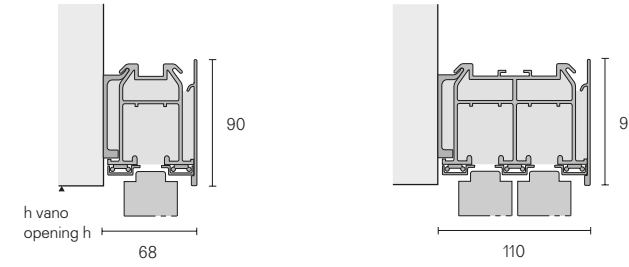

1. Binario di scorrimento con profilo telescopico di aggiustaggio brevettato. Consente la perfetta messa in bolla del binario di scorrimento e di compensare gli eventuali dislivelli del soffitto, senza fasce di tamponamento e spessori aggiuntivi. Dimensioni in lunghezza fino a 6000 mm.
2. Veletta copri-binario in estruso di alluminio. Montaggio rapido ad incastro.
3. Profilo di scorrimento brevettato in estruso d'alluminio.
4. Profilo in alluminio ad incasso totale. Binario di scorrimento dotato di regolazione in altezza di 14 mm.
5. Profilo di ancoraggio a parete in lega di alluminio (EN AW-6005A) temperato. Garantito per carichi di 100 kg per metro lineare.
6. Profilo di copertura brevettato in alluminio ad ancoraggio rapido, in tinta alla struttura della porta scorrevole o predisposto per la verniciatura in loco in tinta al soffitto.

Legierung (EN AW-6005A).  
Garantierte Tragfähigkeit 100Kg pro Laufmeter.  
6. Patentierte Abdeckprofile aus Aluminium mit System zur schnellen Montage. Erhältlich in der Strukturfarbe der Schiebepaneele oder grundiert, um vor Ort in der Deckenfarbe lackiert zu werden.

1. Rail de coulissement avec profil télescopique d'ajustage. Il permet de compenser les éventuels défauts du plafond, sans l'utilisation d'aucun type de tamponnement. Dimensions exceptionnelles en longueur jusqu'à 6000 mm.
2. Bande de fermeture en extrudé d'aluminium. Montage à encastrement rapide.
3. Profil de coulissement breveté en extrudé d'aluminium.
4. Profil en aluminium à encastrement complètement. Rail de coulissement réglable en hauteur de 14 mm.
5. Profil de fixation mural en alliage d'aluminium trempé (EN AW-6005A). Garanti pour poids de 100 Kg par mt.lin.
6. Profil de couverture breveté en aluminium avec système de fixation rapide, dans la même finition de la structure du panneau coulissant ou prêt pour la peinture sur place dans la teinte du plafond.

1. Guía con perfil telescópico de ajuste patentado. Permite ajustar eventuales desniveles del techo, sin bandas y espesores añadidos. Dimensiones excepcionales hasta 6000 mm.
2. Tapa de cierre en extrusión de aluminio. Montaje rápido a encaje.
3. Perfil corredero patentado en extrusión de aluminio.
4. Perfil en aluminio totalmente embutido. Guía dotada de regulación en altura de 14 mm.
5. Perfil de anclaje a pared en aleación de aluminio (EN AW-6005A) templado. Garantizado para cargas de 100 Kg por metro lineal.
6. Perfil embellecedor en aluminio de sujeción rápida patentado, combinado a la estructura del panel corredero o preparado para la pintura en obra combinada al acabado del techo.

1. Laufschiene mit neuem patentierten teleskopischen Profil. Sie erlaubt eine Ausgleichung eventueller Decken-unebenheiten ohne zusätzliche Vorarbeiten. Gesamtlänge von 6000 mm lieferbar.
2. Blende aus gezogenen Aluminiumguss, schnelle Klick-Montage.
3. Patentiertes Laufprofil aus Druckguss Aluminium.
4. Eingebauter Aluminium Profil. Laufschiene regulierbar in Höhe von 14 mm.
5. Decke-Befestigungsprofil aus temperierter Aluminium-

## Binario di scorrimento Sliding rail

1. Binario di scorrimento con profilo telescopico di aggiustaggio brevettato. Consente la perfetta messa in bolla del binario di scorrimento. Regolazione in altezza di 25 mm per la versione a soffitto.
2. Freno soft motion, dotato di molle di richiamo e pistoncino ad olio, inseriti in un supporto in nylon fibra stampato ad iniezione.
3. Carrello di scorrimento. Corpo in nylon basculante su due assi, progettato per seguire le eventuali imperfezioni della parete e del soffitto garantendo uno scorrimento sempre perfetto. Ruote in nylon e fibra di vetro. Portata max 100 kg per carrello.

1. Rail de coulissement avec profilé télescopique d'ajustage breveté. Il permet de mettre parfaitement à niveau le rail de coulissement. Réglage en hauteur de 25 mm pour la version de plafond.
2. Frein soft motion avec ressorts de retour et petit piston à huile, insérés dans un support en fibre de nylon moulé par injection.
3. Chariot de coulissement. Corps en nylon, basculant sur deux axes, étudié pour suivre les éventuelles imperfections du mur et du plafond en garantissant un coulissement toujours parfait. Roulettes en nylon et fibre de verre. Charge maximale de 100 kg par chariot.

1. Sliding rail with patented adjusted telescopic section. Makes perfect levelling of the sliding rail possible as well as compensating for any unevenness in the ceiling. Height adjustment 25 mm, for the ceiling rail version.
2. Soft motion brake, equipped with a recall spring and an oil piston which are inserted into a nylon fibre injection-moulded support.
3. Sliding carriage. Nylon body tipping on two axes, designed to allow any imperfections in the wall and ceiling, always guaranteeing perfect sliding. Nylon and fibreglass wheels. Max loadbearing capacity per carriage 100 kg.

1. Guía de deslizamiento con perfil telescópico de ajuste patentado. Permite un perfecto alineamiento de la guía. Regulación de la altura de 25 mm para la versión de techo.
2. Freno soft motion, equipado con resortes de retorno y de pistón al aceite, colocados en un soporte en fibra de nylon, moldeado por inyección.
3. Carro de deslizamiento. Cuerpo de nylon basculante sobre dos ejes, diseñado para seguir las eventuales imperfecciones de la pared y del techo garantizando un deslizamiento siempre perfecto. Ruedas de nylon y fibra de vidrio. Carga útil máx. 100 kg por carro.

1. Gleitschiene mit patentiertem Teleskopprofil zur Justierung Ermöglicht eine perfekte waagerechte Ausrichtung der Gleitschiene. Höhenregulierung um 25 mm für Deckenschiene.
2. Eingebauter Soft-Motion Bremsen, mit der Rückkehr Federn und Kolben-Öl ausgestattet, die in der spritzgegossenen Unterstützung von Nylon-Faser, eingebaut sind.
3. Laufwagen Doppelgehäuse aus Nylon, zweiachsig schwingend, geplant, um eventuelle Unebenheiten an Wand und Decke auszugleichen und ein perfektes Gleiten in jeder Situation zu garantieren. Rollen aus Nylon und Glasfaser. Höchstlast pro Laufwagen 100 kg.



## Binario in tinta con la struttura o predisposto per la verniciatura Rail in the same finishing of the panel structure or ready to be painted on site

1. Profilo di scorrimento brevettato con microaletture interne, studiate per ridurre e attutire il rumore durante lo scorrimento del pannello.
2. Regolazione in altezza del pannello mediante giunto cardanico laterale: la regolazione è effettuabile anche con il pannello già montato per semplificare al massimo le operazioni di montaggio.
3. Profili di copertura in alluminio predisposti per la verniciatura in loco in tinta al soffitto.
4. Profili di copertura brevettati in estruso di alluminio ad aggancio rapido, in tinta alla struttura delle porte scorrevoli.

1. Patented sliding profile with internal micro finning, designed to reduce and deaden the noise of the panel when it slides.
2. Adjustment in height of the panel thanks to the lateral cardan joint. The adjustment is possible also with the panel already mounted in order to simplify to the maximum the assembly operations.
3. Covering profiles in aluminium prepared to be painted to match the ceiling.
4. Patented covering profiles in extruded aluminium with quick fixing system, in the same finishing of the sliding panels structure.

1. Patentiertes Laufprofil mit Mikroinnenrippen, die die Gleitgeräusche der Türplatte verringern.
2. Höhenregulierung der Türplatte mittels eines Kardangelenkes. Zur weiteren Vereinfachung der Montage ist die Regulierung auch möglich, wenn die Platte bereits installiert ist.
3. Die vor Ort Lackierung der Aluminiumabdeckungen sind in derselben Farbe der Decke erhältlich.
4. Patentierte Schnellkupplung Aluminiumabdeckungen sind in derselben Farbe der Türplatte erhältlich.

1. Profil de coulissement breveté avec des petites ailettes internes, conçu pour réduire et amortir le bruit lors du coulissement du panneau.
2. Réglage en hauteur du panneau par joint de cardan latéral. Le réglage est également réalisable sur le panneau déjà monté afin de simplifier au maximum les opérations de montage.
3. Profils de finition en aluminium préparés pour la peinture sur place dans la même couleur du plafond.
4. Profils de finition en extrusion d'aluminium avec fixation rapide, dans la même couleur de la structure des panneaux coulissants.

1. Guía corredera patentada con micro aletas internas, diseñadas para reducir y amortiguar el ruido durante el deslizamiento del panel.
2. Regulación en altura del panel por medio de cardán lateral. El ajuste también es posible con el panel ya montado para simplificar las operaciones de montaje.
3. Perfiles embellecedores en aluminio preparados para ser pintados en obra en el mismo color del techo.
4. Perfiles embellecedores patentados en extrusión de aluminio con enganche rápido, del mismo color que la estructura del panel.

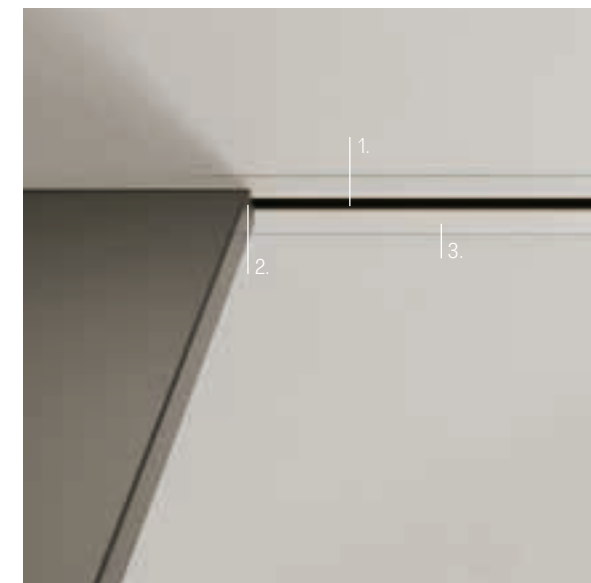



Design Giuseppe Bavuso

## Daimon

Diaphragm, boiserie, decorative element: inspired to the traditional Japanese partition systems, Daimon clearly reflects the aesthetic and functional qualities, as well as graphic and architectural features. An ancient solution, reinterpreted by Rimadesio through the cross between the vertical aluminum ribs and the horizontal decoration lines in the laminated double glass panel. An original and fascinating aesthetic that, thanks to the various combinations of finishes in glass and aluminum components, becomes an interesting opportunity to characterize the space.

Diaframma, boiserie, elemento decorativo: ispirata ai divisori tradizionali giapponesi, Daimon ne ripropone chiaramente le qualità estetiche e funzionali, oltre che grafiche e architettoniche. Una soluzione antica, reinterpretata da Rimadesio attraverso l'incrocio tra le nervature verticali in alluminio e la decorazione a linee orizzontali sul pannello in vetro doppio stratificato. Un'estetica originale e ricca di fascino che, grazie alle varie combinazioni tra le finiture previste nel vetro e i componenti in alluminio, rappresenta una interessante opportunità di caratterizzazione dello spazio.

Membran, Holztafelung, dekoratives Element: Inspiriert an traditionellen japanischen Divisionen, reproduziert Daimon seine ästhetischen und funktionalen Qualitäten, sowie Grafik und Architektur. Eine alte Lösung, die Rimadesio durch die Kreuzung der vertikalen Aluminiumrippen und der horizontalen Liniendekoration auf der zweischichtigen Glasplatte neu interpretiert. Eine originelle Ästhetik voller Charme, die dank der verschiedenen Kombinationen der Oberflächen im Glas und den Aluminiumkomponenten eine interessante Möglichkeit bietet, den Raum charakteristisch zu gestalten.

Diaphragme, boiserie, élément décoratif: inspiré des divisions traditionnelles japonaises, Daimon reproduit clairement ses qualités esthétiques et fonctionnelles, ainsi que son graphisme et son architecture. Une solution ancienne, réinterprétée par Rimadesio à travers l'intersection des profils verticaux en aluminium et la décoration des lignes horizontales sur le panneau de double verre feuilleté. Une esthétique originale pleine de charme qui, grâce aux différentes combinaisons entre les finitions fournies dans le verre et les composants en aluminium, représente une opportunité intéressante pour caractériser l'espace.

Diafragma, boiserie, elemento decorativo: inspirado en las divisiones tradicionales japonesas, Daimon reproduce claramente sus cualidades estéticas y funcionales, así como los gráficos y la arquitectura. Una solución antigua, reinterpretada por Rimadesio a través de la intersección de las nervaduras de aluminio verticales y la decoración de líneas horizontales en el panel de vidrio doble estratificado. Una estética original llena de encanto que, gracias a las diversas combinaciones entre los acabados proporcionados en el vidrio y los componentes de aluminio, representa una oportunidad interesante para caracterizar el espacio.

Struttura e maniglia Structure and handle: 14 brown  
Vetro Glass: 63 grigio trasparente  
Decorazione stratificata in tinta alla struttura  
Laminated decoration matching the structure

Nella foto In this photo  
Tavolo Table: Manta  
Tavolino Coffee table: Planet

Sliding Doors

Il sistema di scorrimento, comune ad ogni porta scorrevole della collezione, è concepito per garantire la massima essenzialità estetica. Così il binario prevede profili di copertura disponibili nelle medesime finiture della struttura delle ante scorrevoli o verniciabili in loco così da risultare uniformi al soffitto.

The sliding system, same for every sliding panel of the collection, has been engineered to grant the maximum aesthetical essentiality. The rail provides covering profiles available in the same finishing of the structure of the sliding panels or to be painted on site, to match the ceiling finishing.

Das Gleitsystem, sozusagen der gemeinsame Nenner jeder Schiebetür der Kollektion, ist so konzipiert, dass die maximale ästhetische Wesentlichkeit gewährleistet wird. Aus diesem Grund sieht die Schiene Lackierungsabdeckungen in derselben Farbe der Schiebetüren vor oder kann vor Ort in einer der Decke gleichenden Farbe lackiert werden.

Le système de coulissement, le même pour tous les panneaux coulissants de la collection, est conçu pour assurer l'essentialité esthétique maximale. Le rail a donc des profils de finition disponibles dans les mêmes finitions que la structure des panneaux coulissants ou laquables sur place de façon à être uniforme au plafond.

El cierre corredero, común a cada puerta corredera de la colección está pensado para garantizar la máxima esencialidad estética. Así la guía está dotada de perfiles embellecedores disponibles en los mismos acabados que la estructura de las hojas correderas o para pintar de manera que queden del mismo acabado que el techo.

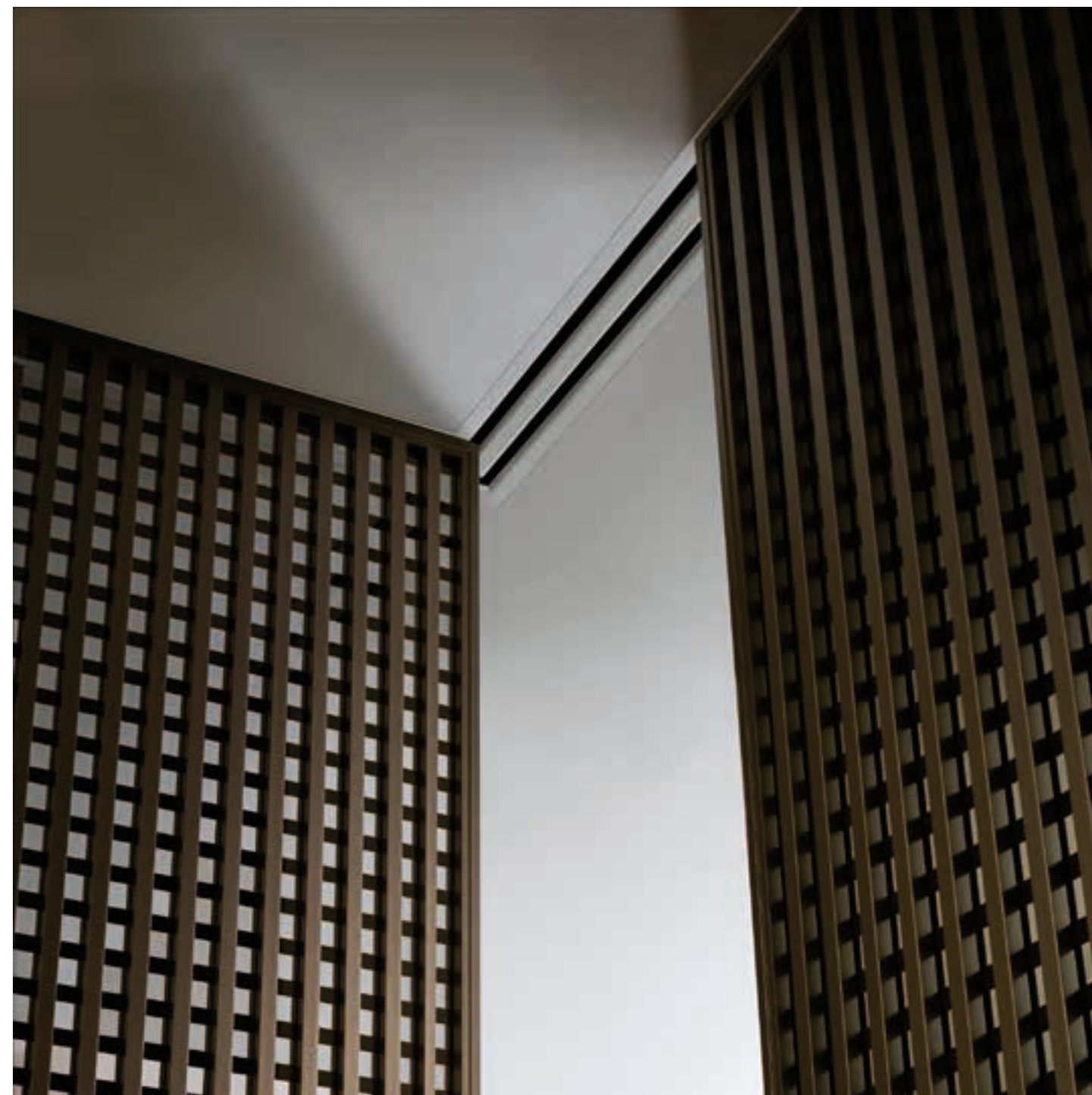



**Caratteristiche tecniche esclusive**  
Exclusive technical features



1. Struttura in alluminio estruso (lega EN AW-6060) in finitura brown. / Extruded aluminium frame (alloy EN AW-6060) in brown finishing.

2. Vetro trasparente grigio con decorazione stratificata brown in tinta alla struttura. Conforme alle norme UNI EN 12543, UNI 7697 e UNI EN 12600. / Transparent grey glass with layered brown decoration in the same finishing of the structure, conforms to UNI EN 12543, UNI 7697 and UNI EN 12600 standards.

**Descrizione tecnica**  
Technical description

I pannelli scorrevoli del sistema Daimon vengono sempre realizzati su misura in altezza e larghezza, fino alle dimensioni massime indicate nello schema a fianco. La maniglia 2015 è disponibile in finitura brown o nero.

Daimon panels are always custom made in height and width according to the dimensions indicated on the scheme in the next page. The handle 2015 is available in brown or black finishing.

Daimon Paneele sind immer nach Mass in Hoehe und Breite hergestellt. Siehe Maximal-Masse, die seitlich angegeben sind. Der Griff 2015 ist in brown oder schwarz verfuegbar.

Les panneaux Daimon sont réalisés toujours sur mesure soit en hauteur qu'en largeur, selon les dimensions maximales indiquées dans le plan à côté. La poignée 2015 est disponible en finition brown et noir.

Los paneles Daimon se realizan siempre a medida en altura y anchura, hasta las dimensiones máximas indicadas en el esquema de al lado. La manilla 2015 está disponible en acabado brown o negro.

**Dimensioni e maniglie**  
Dimensions and handles

Dimensioni pannelli scorrevoli  
Sliding panel dimensions

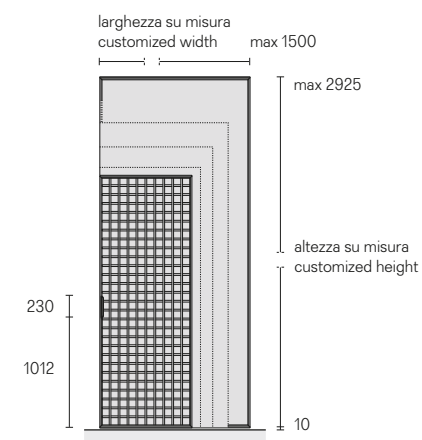

Maniglie  
Handles



1.

2.

1. 2015 maniglia e struttura in alluminio nero. 2015 handle and structure in black aluminium.
2. 2015 maniglia e struttura in alluminio brown. 2015 handle and structure in brown aluminium.



Design Giuseppe Bavuso

## Sail

A perfectly double sided sliding panel combining high technical and functional performance with an original and strong expressive aesthetic value. As result of an accurate technological research and of a complex manual assembly of the components, Sail can be proposed as a real piece of furniture, both in the day and night area. Infinite are the solutions of combination with the Rimadesio glass finishes and aluminum structural elements, also available in walnut or heat-treated oak veneered.

Una porta scorrevole perfettamente bifacciale che associa alte prestazioni tecniche e funzionali a un'estetica originale e dal forte valore espressivo. Risultato di un'attenta ricerca tecnologica e di un complesso lavoro manuale nell'assemblaggio dei componenti, Sail si propone, nell'area giorno come nell'area notte, come un vero e proprio elemento d'arredo. Infinite le soluzioni di abbinamento tra le finiture dei vetri Rimadesio e l'alluminio degli elementi strutturali, disponibili anche nella versione rivestita in noce o rovere termotrattato.

Eine perfekte zweiseitige Schiebetuer, gekennzeichnet durch ihre technische Funktionalitaet und originale Aesthetik. Ergebnis einer sorgfältigen Forschung und Technologie zusammen mit einer komplexen manuellen Montage von Komponenten, ist Sail der geeignete Vorschlag, bestimmt fuer beide Wohn und Nachtbereich, als ein echter Einrichtungsgegenstand. Viele Lösungen mit der Kombination von verschiedenen Ausführungen der Rimadesio Glaeser und Aluminium der Strukturelemente, verfuegbar auch in Nussbaum oder thermo-behandelter Eiche furniert.

Un panneau coulissant parfaitement double face combinant haute performance technique et fonctionnelle avec une esthétique originale et avec une forte valeur expressive. Résultat d'une recherche technologique minutieuse et d'un complexe travail manuel dans l'assemblage de composants, Sail se présente comme une vraie pièce de mobilier dans la zone jour aussi que dans la zone nuit. Infinies sont les solutions de combinaison entre les finitions des verres Rimadesio et les éléments structuraux en aluminium, également disponible plaqué en noyer ou en chêne thermo traité.

Una puerta corredera perfectamente bifacial que combina altos rendimientos técnicos y funcionales con una estética original y del fuerte valor expresivo. Resultado de una atenta investigación tecnológica y de un complejo montaje manual de los componentes, Sail se propone, tanto en la zona de día como en la de noche, como una verdadera pieza de mobiliario. Infinitas las soluciones de combinación entre los acabados de los cristales Rimadesio y el aluminio de los elementos estructurales, también disponibles en la versión chapada en madera de nogal o roble termotrattado.

Struttura e maniglia Structure and handle: 15 noce  
Vetro Glass: 63 grigio trasparente  
Binari in tinta al soffitto Rails matching the ceiling

Nella foto In this photo  
Contenitori a parete  
Wall suspended units: Self  
Mensole Shelves: Eos

Sliding Doors



Ideale sia per la zona giorno che per la zona notte, Sail è una porta scorrevole che separa gli spazi ma anche un elemento d'arredo capace di caratterizzare interni sofisticati ed eleganti. Essenziale e minimale ma allo stesso tempo espressiva e dalla forte identità grazie ai traversi verticali in legno che la connotano, Sail è realizzata su misura in altezza e larghezza ed è in grado di inserirsi in qualsiasi vano disponibile.

Ideal for both day and night areas, Sail is a sliding panel that can divide spaces but at the same time a real piece of furniture to characterize sophisticated and elegant interiors. Essential and minimal but at the same time expressive and with a strong identity, thanks to its distinctive vertical wooden crosspieces, Sail is custom-made both in height and width and can be adapted to any existing opening.

Ideal für den Wohnzimmer und den Schlafzimerbereich, ist Sail ein Schiebetürsystem das als Raumtrenner geeignet ist und gleichzeitig eleganter Einrichtungsgegenstand ist. Essenziell und minimalistisch aber zugleich aber auch aussagestark dank der vertikalen Sprossen. Sail wird in der Höhe und der Breite auf Mass produziert

Idéal soit pour la zone jour que pour la zone nuit, Sail est un panneau coulissant qui sépare les espaces, mais aussi élément de décoration qui permet d'identifier des intérieurs élégants et sophistiqués. Essentiel et minimale, mais en même temps d'expression et de forte identité grâce aux traverses en bois verticales qui le caractereise, Sail est toujours sur mesure en hauteur et en largeur et donc adaptable aux différentes ouvertures.

Ideal tanto para la zona de día, como para la zona de noche, Sail es una puerta corredera que separa los espacios. Pero también un mueble capaz de caracterizar interiores sofisticados y elegantes. Esencial y mínima, pero al mismo tiempo expresiva y fuerte de identidad gracias a los travesaños verticales de madera que la connotan, Sail está hecha a medida en altura y anchura y es capaz de encajar en cualquier espacio disponible.

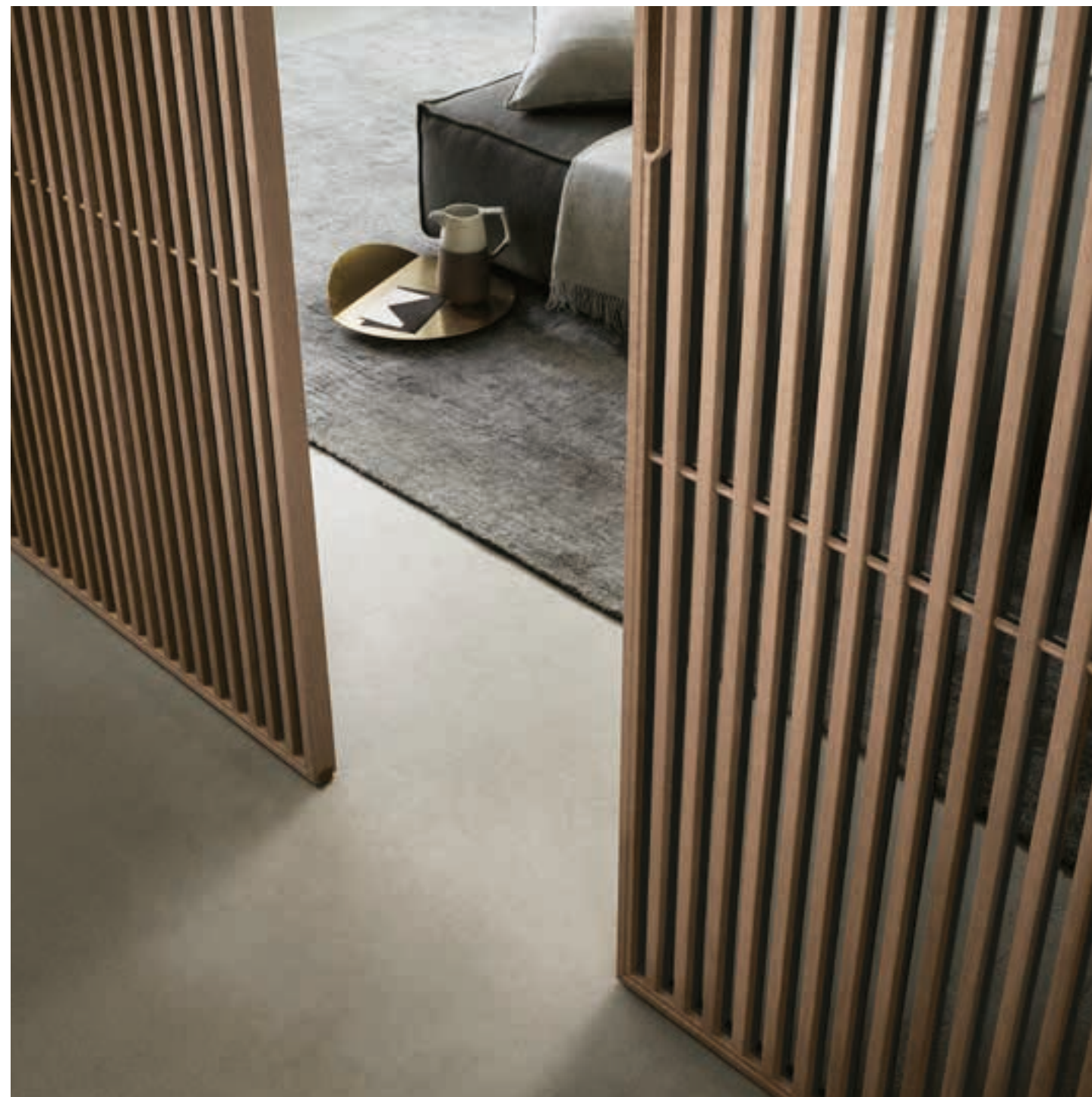

## Caratteristiche tecniche esclusive Exclusive technical features



1. Struttura in alluminio estruso (lega EN AW-6060) con rivestimento in vero legno. / Extruded aluminium frame (alloy EN AW-6060) with real wood finish.
2. Vetro temperato spessore 8 mm, conforme alle norme UNI EN 12150, UNI 7697 e UNI EN 12600. / Tempered glass, 8 mm thick, conforms to UNI EN 12150, UNI 7697 and UNI EN 12600 standards.

## Tipologie estetiche in altezza Height typology

Pannello con due traversi orizzontali / Panel with two horizontal crosspieces

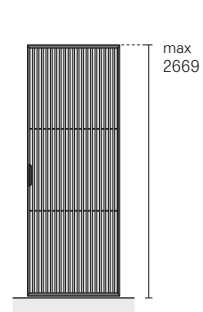

Pannello con tre traversi orizzontali / Panel with three horizontal crosspieces

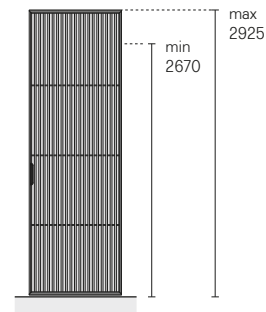

## Descrizione tecnica Technical description

I pannelli scorrevoli del sistema Sail vengono sempre realizzati su misura in altezza e larghezza, fino alle dimensioni massime indicate nello schema. Caratterizzato da traversi verticali, Sail è proposto con struttura in alluminio rivestito in noce e rovere termotrattato o in alluminio brown, piombo, grafite, bronzo e nero.

Sail panels are always custom made in height and width according to the dimensions indicated on the scheme. Characterized by vertical crosspieces, Sail is available with walnut and heat-treated oak veneered aluminium structure or in brown, piombo, grafite, bronzo and black aluminium.

Sail Paneele sind immer nach Mass in Hoehe und Breite hergestellt. Siehe Maximal-Masse, die seitlich angegeben sind. Gekennzeichnet durch vertikale Sprossen, Sail wird mit einem Aluminiumrahmen aus Nussbaum und thermobehandelter Eiche verkleidet oder aus Aluminium Brown, Piombo, Grafite, Bronzo und Nero angeboten.

Les panneaux Sail sont réalisés toujours sur mesure soit en hauteur qu'en largeur, selon les dimensions maximales indiquées de côté dans le plan. Caractérisé par des traverses verticales, Sail est proposé avec une structure en aluminium revêtue en noyer et chêne thermo traité ou aluminium brown, piombo, grafite, bronze et noir.

Los paneles Sail se realizan siempre a medida en altura y anchura, hasta las dimensiones máximas indicadas en el esquema abajo. Caracterizado por travesaños verticales, Sail se propone con estructura en aluminio revestido de nogal y roble termotrattado o en aluminio brown, piombo, grafite, bronzo y negro.

## Dimensioni e maniglie Dimensions and handles

Dimensioni pannelli scorrevoli  
Sliding panel dimensions

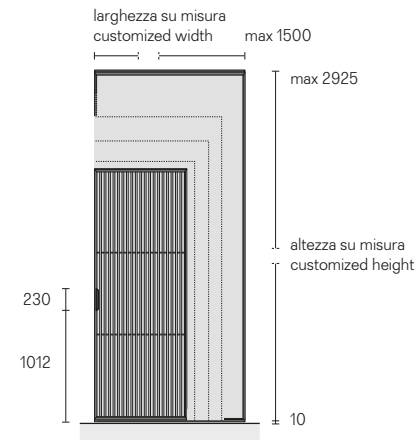

Maniglie  
Handles

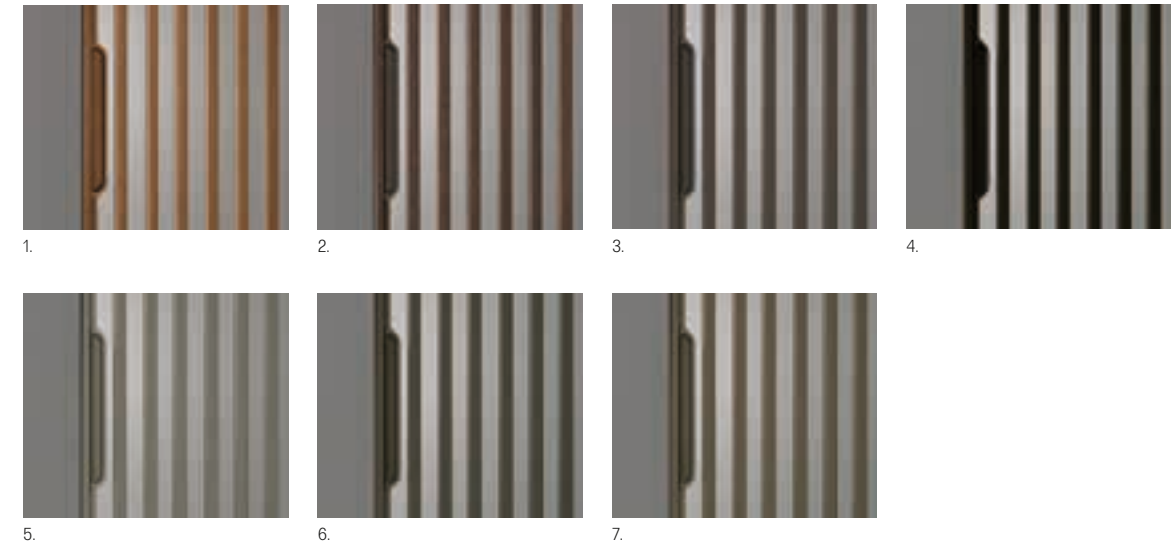

1. 2015 maniglia in noce e struttura in alluminio rivestito in noce. 2015 walnut handle and walnut veneered aluminium structure.
2. 2015 maniglia in alluminio brown, nero e bronzo, struttura in alluminio rivestito in rovere termotrattato. 2015 brown, black, piombo, grafite and bronzo aluminium handle with heat-treated oak veneered aluminium structure.
3. 2015 maniglie e struttura in alluminio brown. 2015 brown aluminium handle and structure.
4. 2015 maniglie e struttura in alluminio nero. 2015 Black aluminium handle and structure.
5. 2015 maniglie e struttura in alluminio piombo. 2015 piombo aluminium handle and structure.
6. 2015 maniglie e struttura in alluminio grafite. 2015 grafite aluminium handle and structure.
7. 2015 maniglie e struttura in alluminio bronzo. 2015 bronzo aluminium handle and structure.



Design Giuseppe Bavuso

## Soho

Lightness, transparency, ability to split and join at the same time. The references to far East are clearly visible in Soho, the sliding doors collection, which refers to the typical partitions of the movable walls and the furnishings that identify the traditional Japanese house. An ethereal diaphragm, with delicate ribs which settle up the geometry of the frame reproduced in a contemporary and current context from the combination of Rimadesio's finishing.

Leggerezza, trasparenza, capacità di dividere e unire allo stesso tempo. I riferimenti all'estremo oriente sono espliciti in Soho, la collezione di porte scorrevoli che rimanda alla partitura tipica delle pareti mobili e degli arredi che identificano l'abitazione tradizionale giapponese. Un diaframma etereo, che gioca sulle delicate nervature che compongono la geometria del telaio riproposto in un contesto contemporaneo e reso attuale dalla combinazione delle finiture Rimadesio.

Die Auszeichnung durch Leichtigkeit, Transparenz, und der Fähigkeit den Raum gleichzeitig zu teilen und zu vereinen. Die Anspielungen auf den Fernen Osten sind in der Soho Linie erkennbar, einer Sammlung von Schiebetüren, die sich auf die typische Bewertung der mobilen Wände und Möbel bezieht, die das traditionelle japanische Zuhause kennzeichnen. Eine himmlische Membran, die auf die feinen Rippen der Geometrie des Rahmens anspielt, die in einem zeitgenössischen Kontext und durch die Kombination von Rimadesio-Finituren aktuell gemacht wird.

Légèreté, transparence, capacité de séparer et joindre en même temps. Les références à l'extrême-orient sont explicites dans Soho, la collection de panneaux coulissants, qui fait référence à la division typique des cloisons mobiles et des meubles, qui identifient la maison japonaise traditionnelle. Un diaphragme éthéré, qui joue sur les nervures délicates, qui composent la géométrie de la structure re-proposé dans un contexte contemporain et rendu actuel par la combinaison des finitions Rimadesio.

Ligereza, transparencia, capacidad de dividir y unir al mismo tiempo. Las referencias al Extremo Oriente son explícitas en Soho, la colección de paneles correderos que se refiere a la partitura típica de las paredes móviles y el mobiliario que identifican el hogar japonés tradicional. Un diafragma etéreo, que juega con las delicadas nervaduras que conforman la geometría de la estructura re-propuesta en un contexto contemporáneo y actualizado por la combinación de los acabados de Rimadesio.

Struttura Structure: 15 noce  
Vetro Glass: 67 riflettente chiaro  
Maniglia Handle: 14 brown

Nella foto In this photo  
Contentore a parete  
Suspended cabinet: Self



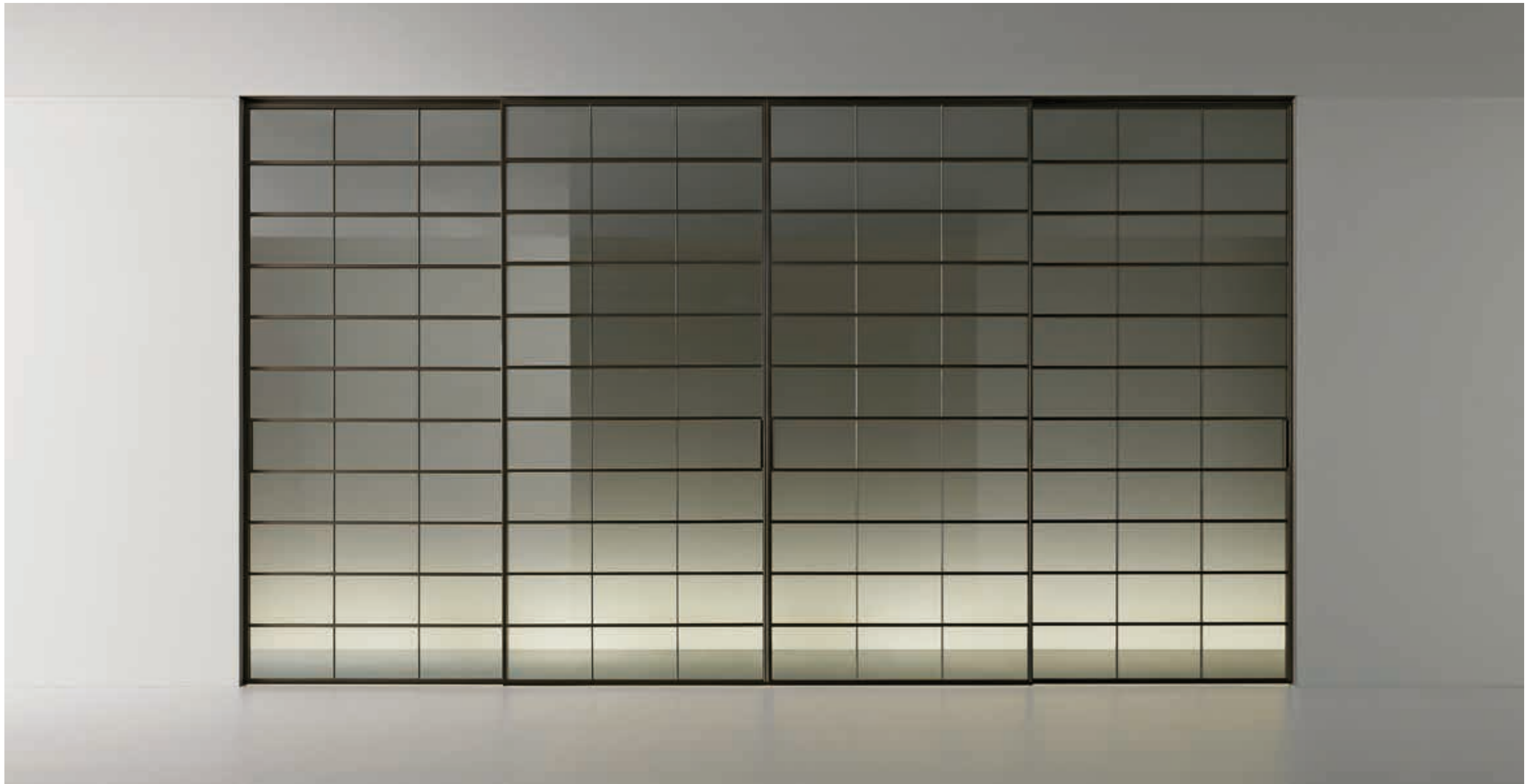



**Caratteristiche tecniche esclusive**  
Exclusive technical features



1. Struttura in alluminio estruso (lega EN AW-6060) con rivestimento in vero legno. / Extruded aluminium frame (alloy EN AW-6060) whit real wood finish.
2. Vetro temperato spessore 8 mm, conforme alle norme UNI EN 12150, UNI 7697 e UNI EN 12600. Tempered glass, 8 mm thick, conforms to UNI EN 12150, UNI 7697 and UNI EN 12600 standards.

**Dimensioni e maniglie**  
Dimensions and handles

Dimensioni pannelli scorrevoli  
Sliding panel dimensions

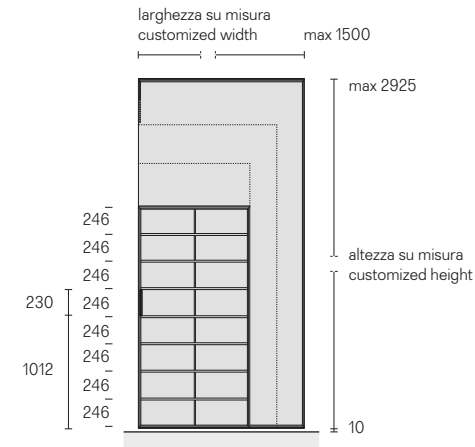

**Tipologie estetiche**  
Aesthetical typologies

In larghezza / Width

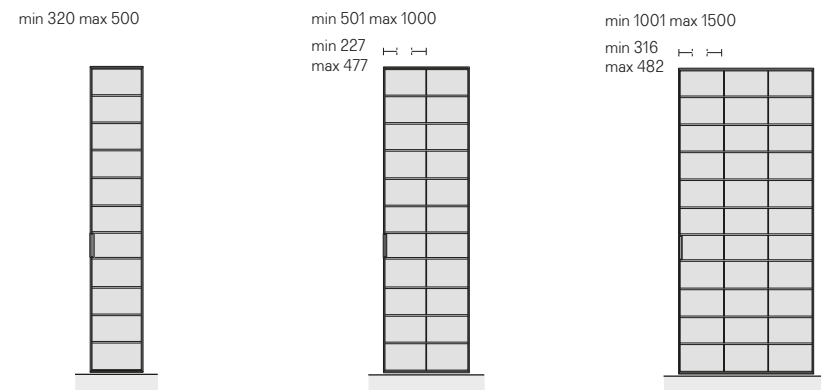

In altezza / Height

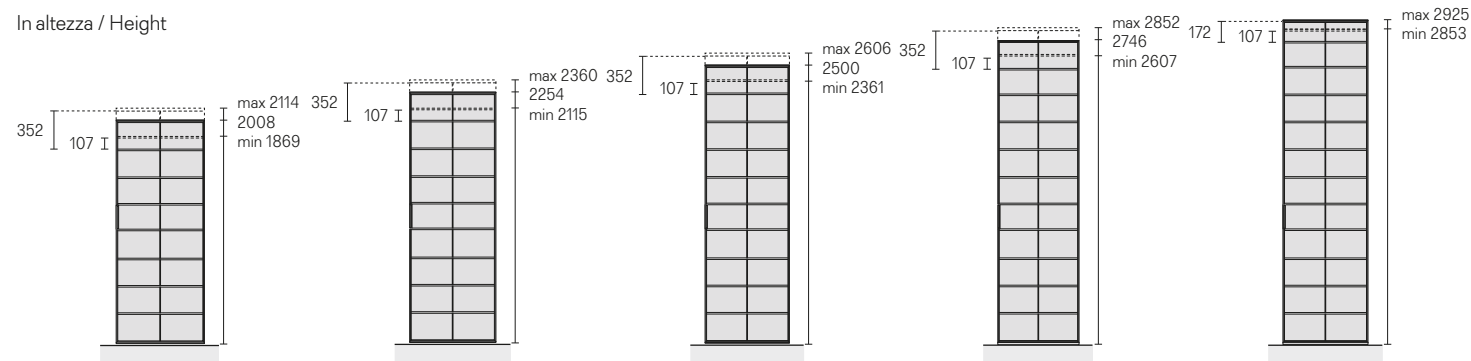

**Descrizione tecnica**  
Technical description

I pannelli scorrevoli del sistema Soho vengono sempre realizzati su misura in altezza e larghezza, fino alle dimensioni massime indicate nello schema della pagina accanto.

Soho panels are always custom made in height and width according to the dimensions indicated on the scheme in the next page.

Soho Paneele sind immer nach Mass in Hoehe und Breite hergestellt. Siehe Maximal-Masse, die auf der gegenüberliegenden Seite sind.

Les panneaux Soho sont réalisés toujours sur mesure soit en hauteur qu'en largeur, selon les dimensions maximales indiquées de côté dans le plan.

Los paneles Soho se realizan siempre a medida en altura y anchura, hasta las dimensiones máximas indicadas en el esquema en la página siguiente.

Maniglie  
Handles



1. 2016 maniglia brown, struttura in alluminio rivestito in noce. / 2016 handle brown, walnut veneered aluminium structure.
2. 2016 maniglia brown, struttura in alluminio rivestito in rovere termotrattato. 2016 handle brown, heat-treated oak veneered aluminium structure.
3. 2016 maniglia e struttura in alluminio brown, nero, bianco latte, nei 34 colori laccati Ecolorsystem. 2016 Aluminium handle and aluminium structure in brown, black, bianco latte, 34 Ecolorsystem lacquered colours.



Design Giuseppe Bavuso

## Velaria

Sliding doors interpreted with the utmost geometrical rigour. In the project panels are always custom made with a structural aluminium profile in minimum thickness, that makes the most of the exclusive aesthetic features of the Rimadesio glass. The system is provided with patented innovative technical solutions, to guarantee the utmost freedom of design, along with easy installation and exceptional reliability over the years.

L'interpretazione della porta scorrevole all'insegna del massimo rigore geometrico. Un progetto in cui i pannelli vengono realizzati sempre su misura, con un profilo strutturale in alluminio di minimo spessore che valorizza al massimo le qualità estetiche esclusive del vetro Rimadesio. Un sistema dotato di innovative soluzioni tecniche brevettate, per garantire la più ampia libertà progettuale, associata alla semplicità di installazione e ad un'eccezionale affidabilità nel tempo.

Die Interpretation der Schiebetür im Zeichen größter geometrischer Strenge. Ein Entwurf mit ausschließlich maßgefertigten Türplatten und einem Aluminium-Strukturprofil in geringstmöglicher Stärke, das die exklusiven ästhetischen Vorzüge des Rimadesio-Glases bestens betont. Ein System, dessen innovative, patentierte technische Lösungen höchste gestalterische Freiheit ebenso gewähren wie einfache Einbauverfahren und außerordentliche Zuverlässigkeit.

L'interprétation de la porte coulissante à l'enseigne de la rigueur géométrique maximale. Un projet pour lequel les panneaux sont toujours réalisés sur mesure, avec un profil structural en aluminium d'épaisseur minimum qui met en valeur au maximum les qualités esthétiques exclusives du verre Rimadesio. Un système doté de solutions techniques innovantes brevetées afin de garantir la plus grande liberté conceptuelle, associée à la simplicité d'installation et à une exceptionnelle fiabilité dans le temps.

La interpretación de la puerta corredera se caracteriza por el rigor geométrico más absoluto. Un proyecto en el que los paneles se realizan siempre a medida, con un perfil estructural de aluminio de reducido espesor que valoriza al máximo las cualidades estéticas exclusivas del cristal Rimadesio. Un sistema dotado de innovadoras soluciones técnicas patentadas, para poder garantizar una mayor libertad de diseño, asociada a la sencillez de instalación y a una excepcional fiabilidad con el paso del tiempo.







La versatilità progettuale del sistema Velaria consente di formulare proposte compositive evolute, fino a soluzioni che delimitano gli spazi con risultati di grande originalità.

The Velaria system's versatile design allows formulation of highly advanced compositive proposals to achieve solutions that define spaces featuring original results.

Dank der gestalterischen Vielseitigkeit des Systems Velaria lassen sich ausgefeilte Kombinationen erstellen, bis hin zu äußerst originellen Lösungen zur Abgrenzung der Wohnbereiche.

La versatilité conceptuelle du système Velaria permet de formuler des propositions de composition évoluées, et même des solutions qui délimitent les espaces avec des résultats très originaux.

La versatilidad de proyecto del sistema Velaria permite formular propuestas de composición avanzadas, hasta llegar a soluciones que definen los espacios con resultados de gran originalidad.



**Caratteristiche tecniche esclusive**  
Exclusive technical features



1. Struttura in alluminio estruso (lega EN AW-6060) in finitura brown. / Extruded aluminium frame (alloy EN AW-6060) in brown finishing.
2. Vetro satinato temperato spessore 8 mm, conforme alle norme UNI EN 12150, UNI 7697 e UNI EN 12600. Tempered, satin-finish glass, 8 mm thick, conforms to UNI EN 12150, UNI 7697 and UNI EN 12600 standards.

**Descrizione tecnica**  
Technical description

I pannelli scorrevoli del sistema Velaria vengono sempre realizzati su misura in altezza e larghezza, fino alle dimensioni massime indicate nello schema a fianco. Velaria utilizza il binario di scorrimento Rimadesio, che consente una perfetta messa in bolla, assicurando movimenti perfettamente calibrati, anche nelle composizioni di grandi dimensioni.

The sliding panels of the system Velaria are always custom made both in height and width, with maximum dimensions as per the scheme on next page. Velaria uses the Rimadesio sliding rail, which allows a perfect levelling, guaranteeing perfectly smooth movements, even with compositions of big dimensions.

Die Schiebepaneele des Velaria Systems werden immer nach Maß, sowohl in der Höhe als auch in der Breite, gearbeitet. Maximale verfügbaren Abmessungen laut seitlichem Schema. Bei Velaria verwendet Rimadesio eine spezielle Schiene, die die perfekte Nivellierung und Bewegung auch mit großen Anlagen ermöglicht.

Les panneaux coulissants du système Velaria sont toujours réalisés sur mesure en hauteur et largeur, jusqu'aux dimensions maximales indiquées dans le plan à côté. Velaria utilise le rail de coulissement Rimadesio, qui permet une parfaite mise à niveau, en assurant mouvements parfaits, en particulier dans les grandes compositions.

Los paneles correderos Velaria son siempre realizados a medida en altura y anchura, hasta las dimensiones máximas indicadas en el esquema de al lado. Velaria utiliza la guía Rimadesio, que asegura movimientos perfectamente alineados, también en las composiciones de grandes dimensiones.

**Dimensioni e maniglie**  
Dimensions and handles

Dimensioni pannelli scorrevoli  
Sliding panel dimensions

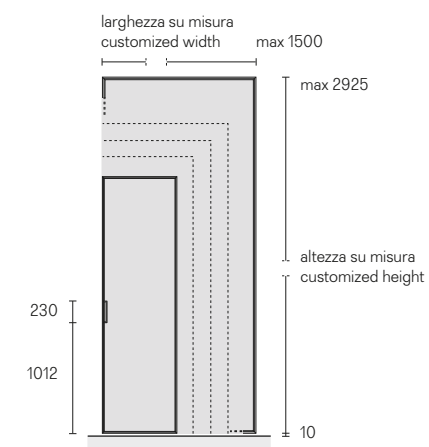

Maniglie  
The handles



1. 2005 maniglia. / 2005 handle.
2. 3205 maniglia. / 3205 handle.
3. 2093 maniglia con nottolino. 2093 handle with revolving plug.



Design Giuseppe Bavuso

## Stripe

The typical aluminium crosspieces are installed on both sides of the panels, making them perfectly double-sided and ideal for any section of the house, from living to night areas, as well as for professional settings. A high graphic value solution, where the horizontal crosspieces give rhythm to the light filtering through the glass panel with always different results.

I caratteristici traversi in alluminio sono presenti su entrambi i lati delle porte, rendendole così perfettamente bifacciali e ideali per ogni area della casa, dalla zona giorno all'area notte, così come per gli ambienti professionali. Una soluzione dal forte valore grafico, in cui la luce che filtra dal pannello in vetro è ritmata con risultati sempre diversi dall'orizzontalità del disegno dei traversi.

Die charakteristischen Aluminium-Querbalken sind auf beiden Seiten der Türen vorhanden und somit ideal für jeden Bereich des Hauses, vom Wohn- und Schlaf- bis zum Arbeitsbereich. Es handelt sich um eine Lösung mit einem starken visuellen Wert, bei der das durch die Glasscheibe gefilterte hindurchfließende Licht durch die Horizontalität des Querbalken- signs bestimmt wird.

Les caractéristiques traverses en aluminium sont présentes des deux côtés des panneaux, ce qui les rend parfaitement bifaces et idéales pour tous les espaces de la maison, de la zone jour à la zone nuit, ainsi que pour les environnements professionnels. Une solution avec une forte valeur graphique, dans laquelle la lumière, qui filtre à travers le panneau de verre, est rythmée avec des résultats toujours différents de l'horizontalité de la conception des traverses.

Los característicos travesaños de aluminio están presentes en ambos lados de las puertas, haciéndolos perfectamente bifaciales e ideales para cada área del hogar, de la zona día a la zona noche, así como también para entornos profesionales. Una solución con un fuerte valor gráfico, en la que la luz que se filtra a través del panel de vidrio es rítmica con resultados siempre diferentes de la horizontalidad del diseño de los travesaños.







**Caratteristiche tecniche esclusive**  
Exclusive technical features



1. Struttura in alluminio estruso (lega EN AW-6060) in finitura brown. Extruded aluminium frame (alloy EN AW-6060) in brown finishing.
2. Vetro temperato spessore 8 mm, conforme alle norme UNI EN 12150, UNI 7697 e UNI EN 12600. Tempered, satin-finish glass, 8 mm thick, conforms to UNI EN 12150, UNI 7697 and UNI EN 12600 standards.
3. Binario di scorrimento ad incasso totale. Built-in sliding rail.
4. Regolazione in altezza del pannello. Panel height adjusting.

**Descrizione tecnica**  
Technical description

I pannelli scorrevoli del sistema Stripe vengono sempre realizzati su misura in altezza e larghezza, fino alle dimensioni massime indicate nello schema a fianco. Stripe utilizza il binario di scorrimento Rimadesio, che consente una perfetta messa in bolla, assicurando movimenti perfettamente calibrati, anche nelle composizioni di grandi dimensioni.

The sliding panels of the system Stripe are always custom made both in height and width, with maximum dimensions as per the scheme on next page. Stripe uses the Rimadesio sliding rail, which allows a perfect levelling, guaranteeing perfectly smooth movements, even with compositions of big dimensions.

Die Schiebepaneele des Stripe Systems werden immer nach Maß, sowohl in der Höhe als auch in der Breite, gearbeitet. Maximale verfügbaren Abmessungen laut seitlichem Schema. Bei Stripe verwendet Rimadesio eine spezielle Schiene, die die perfekte Nivellierung und Bewegung auch mit großen Anlagen ermöglicht.

Les panneaux coulissants du système Stripe sont toujours réalisés sur mesure en hauteur et largeur, jusqu'aux dimensions maximales indiquées dans les plans à côté. Stripe utilise le rail de coulissement Rimadesio, qui permet une parfaite mise à niveau, en assurant mouvements parfaits, en particulier dans les grandes compositions.

Los paneles correderos Stripe son siempre realizados a medida en altura y anchura, hasta las dimensiones máximas indicadas en los esquemas de al lado. Stripe utiliza la guía Rimadesio, que asegura movimientos perfectamente alineados, también en las composiciones de grandes dimensiones.

**Dimensioni e maniglie**  
Dimensions and handles

Dimensioni pannelli scorrevoli  
Sliding panel dimensions

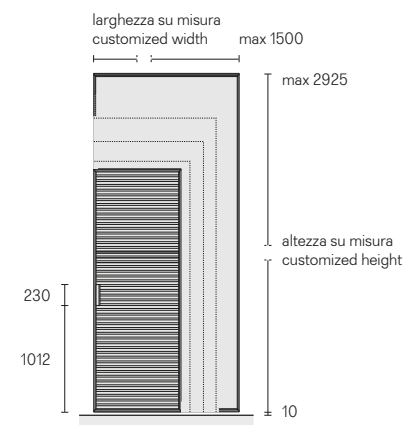

Maniglie  
Handles

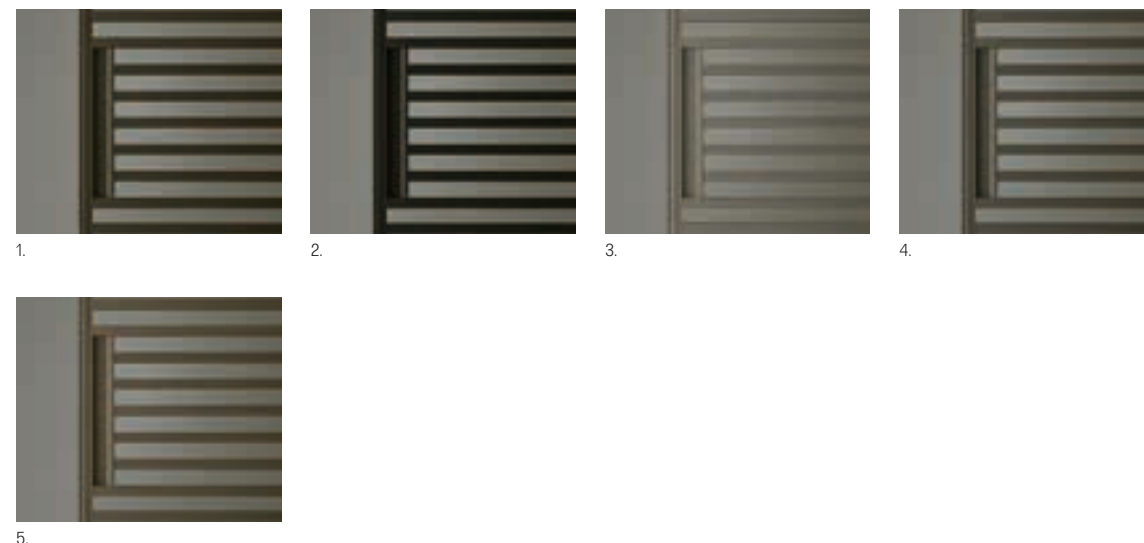

1. 2012 maniglie e struttura in alluminio brown. 2012 Brown aluminium handle and structure.
2. 2012 maniglie e struttura in alluminio nero. 2012 black aluminium handle and structure.
3. 2012 maniglie e struttura in alluminio piombo. 2012 piombo aluminium handle and structure.
4. 2012 maniglie e struttura in alluminio grafite. 2012 grafite aluminium handle and structure.
5. 2012 maniglie e struttura in alluminio bronzo. 2012 bronzo aluminium handle and structure.



Design Giuseppe Bavuso

## Graphis plus

Inspired by the utmost aesthetic essentiality, the Graphis plus doors are composed of panels in lacquered glass, gres or synthetic leather, surrounded by a structural aluminium profile of minimum thickness. Always custom made, the doors have a recessed metal handle with an insert in the same finish as the panel.

Inspirate alla massima essenzialità estetica, le ante Graphis plus sono composte da pannelli in vetro laccato, grès o similpelle, conclusi da un profilo strutturale in alluminio di minimo spessore. Sempre su misura, le ante sono dotate di maniglia incassata in metallo con inserto nella stessa finitura del pannello.

Inspiziert von höchster ästhetischer Essenz bestehen die Graphis Plus Paneele aus lackiertem Glas, Grès oder Kunstleder, ergänzt durch ein Strukturprofil aus Aluminium mit einer minimalen Stärke. Die Türen werden immer nach Maß gefertigt und haben einen versenkten Metallgriff mit einem Einsatz in der gleichen Ausführung wie das Paneel.

Inspirées par la plus grande essentialité esthétique, les portes Graphis plus sont composées de panneaux en verre laqué, grès ou similcuir complétées par un profil structurel en aluminium d'épaisseur minimale. Toujours sur mesure les portes ont une poignée encastrée métallique avec insert dans la même finition que le panneau.

Inspiradas en la máxima esencialidad estética, los sistemas Graphis plus están compuestos de paneles en vidrio lacado, grès o simil cuero, concluidos con un perfil estructural en aluminio de espesor mínimo. Siempre hechas a medida, las puertas tienen una manilla de metal empotrada con un inserto en el mismo acabado que el panel.

Struttura Structure: 83 piombo  
Pannello porta Door panel:  
G003 gres piedra

Nella foto In this photo  
Storage system Storage system: Cover

Sliding Doors



La struttura in alluminio e la maniglia incassata sono disponibili in alluminio, bianco latte, brown, nero e nella gamma Ecolorsystem, composta da 34 colori realizzati con vernici idrosolubili di ultima generazione.

The structure in aluminum and the recessed handle available in aluminum, bianco latte, brown, nero and in the Ecolorsystem range, composed by 34 colors realized with latest generation water-soluble paintings.

Der Aluminiumrahmen und die Griffmulde sind in den Farben aluminium, bianco latte, braun, nero und Ecolorsystem erhältlich. Sie bestehen aus 34 Farben, die mit den wasserlöslichen Farben der neuesten Generation hergestellt wurden.

La structure en aluminium et la poignée encastrée sont disponibles en aluminium, bianco latte, brown, noir et dans la gamme Ecolorsystem, composée de trente-sept couleurs réalisées avec des peintures à base d'eau de dernière génération.

El marco de aluminio y el tirador empotrado están disponibles en Aluminio, Bianco latte, Brownn, negro y en la gama Ecolorsystem, compuesta por 34 colores fabricados con pinturas solubles en agua de última generación.









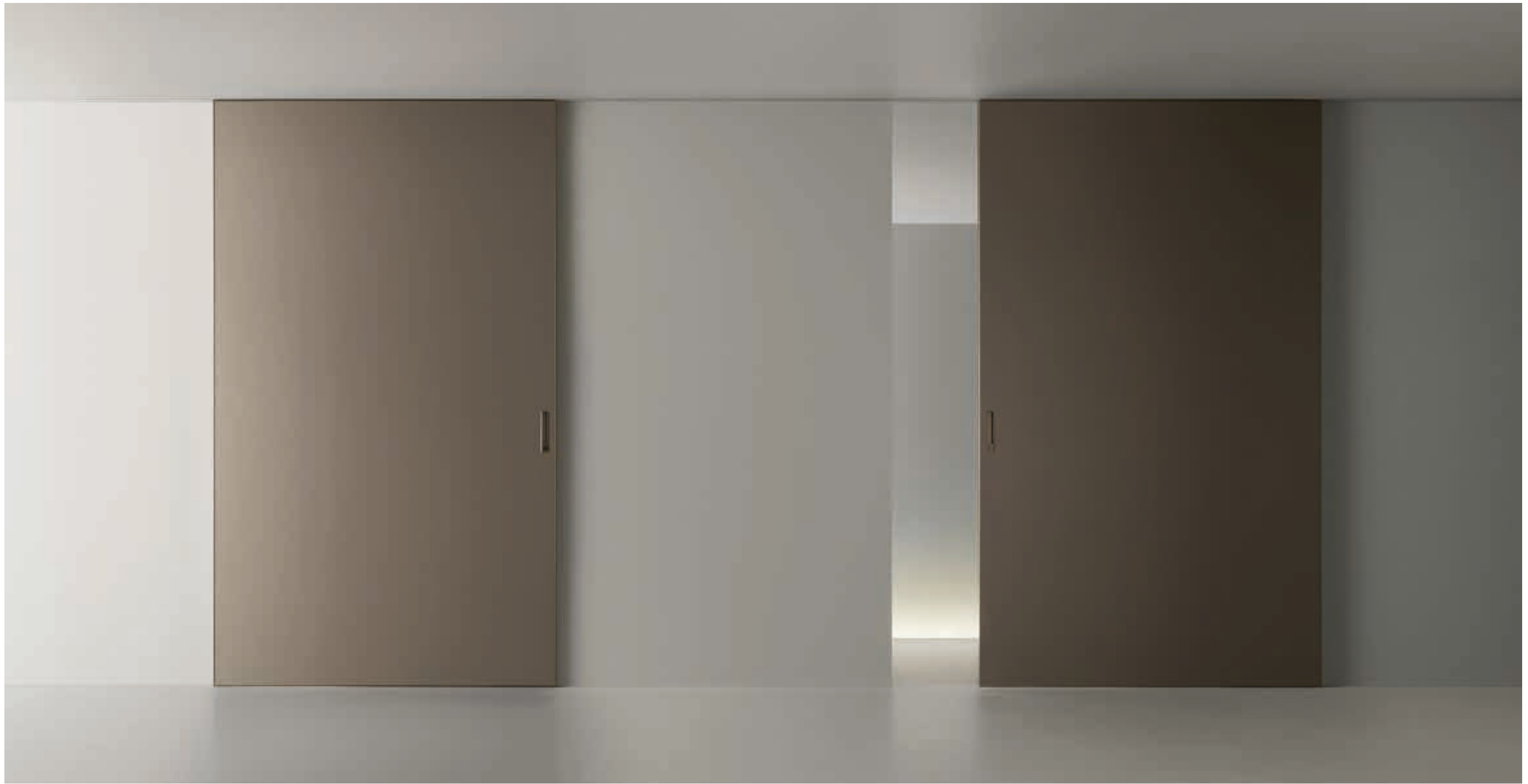



Design Giuseppe Bavuso

## Graphis light

Graphis light is the proposal especially designed to close niches and walk-in closets. A complementary proposal to the sliding panels Graphis plus, characterised in the light version by its single glazed panel, associated to an aluminium structure, perfectly dust-proof, thanks to an exclusive perimeter joint.

Graphis light è il sistema specificamente dedicato alla zona notte, pensato per chiudere cabine armadio e nicchie. Una proposta complementare alle porte scorrevoli Graphis plus, che nella versione light si caratterizzano per il pannello in vetro laccato monofronte, coniugando leggerezza e purezza del design. Il sistema è definito da un profilo strutturale in alluminio, dotato di esclusive guarnizioni in gomma siliconica e polipropilene che garantiscono la perfetta tenuta alla polvere.

Graphis light ist das System, das dem Schlafbereich gewidmet ist, um begehbare Kleiderschränke und Nischen zu schließen. Der Entwurf ergänzt die Schiebetüren Graphis plus, die sich in der Version light durch eine einseitig lackierte Platte auszeichnen und Leichtigkeit und Reinheit des Designs miteinander vereinen. Das System besteht aus einem Strukturprofil aus Aluminium und ist mit exklusiven Dichtungen aus silikonbehandeltem Gummi und Polypropylen ausgestattet, die einen optimalen Staubschutz bieten.

Graphis light est le système conçu pour fermer des niches et cabines armoire. Une proposition complémentaire aux panneaux coulissants Graphis plus que dans la version Light se caractérisent par le panneau en verre laqué, d'une seule face, où légèreté et pureté se lient parfaitement. Le système est caractérisé par un profil structural en aluminium avec des profils en caoutchouc de silicone et polypropylène qui garantissent une fermeture hermétique.

Graphis light es el sistema específicamente dedicado a la zona de noche, diseñado para cerrar vestidores y espacios. Una propuesta complementaria a los paneles correderos Graphis plus, que en la versión light se caracteriza por el panel en cristal lacado de frente único, que combina la ligereza y la pureza del design. El sistema se define por un perfil estructural en aluminio, dotado de exclusivas guarniciones en goma de silicona y polipropileno que garantizan el perfecto cierre hermético contra el polvo.

Struttura Structure: 16 bianco latte  
Vetro Glass: 108 bianco latte opaco  
Maniglia incassata con inserto in tinta al pannello  
Handle with glass insert matching the panel  
Binari in tinta al soffitto Rails matching the ceiling

Nella foto In this photo  
Tavolino Coffee table: Planet





## Caratteristiche tecniche esclusive Exclusive technicals features

Graphis plus

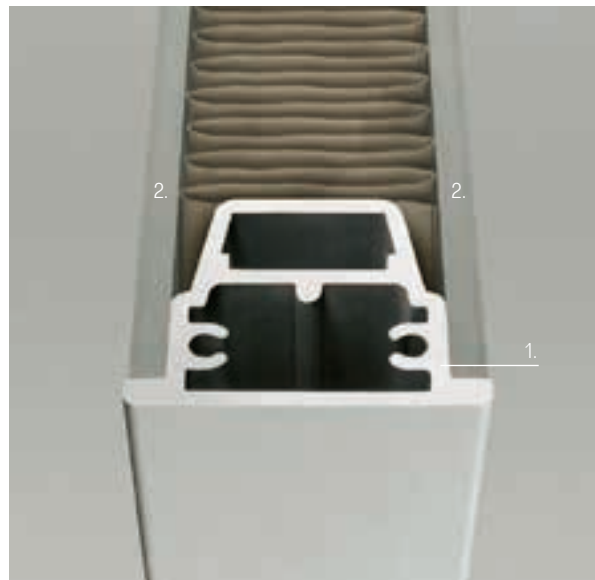

1. Telaio in estruso d'alluminio (lega EN AW-6060 stato fisico T6). Ossidazione anodica conforme alle norme EN 12373, UNI EN ISO 2360. Frame in extruded aluminium (alloy EN AW-6060 physic state T6). Anodic oxidation according to EN 12373, UNI EN ISO 2360 rules.
2. Doppio vetro temperato 4+4 mm in versione laccato, satinato e riflettente. Conformi alle norme UNI EN 12150, UNI 7697 e UNI EN 12600 in materia di sicurezza per i vetri d'arredamento. / Double 4+4 mm tempered glass in lacquered, satin-finish, and reflecting versions. In accordance with the UNI EN 12150, UNI 7697 and UNI EN 12600 rules with reference to the security of glasses for decoration purposes.

Graphis light



1. Telaio in estruso d'alluminio (lega EN AW-6060 stato fisico T6). Ossidazione anodica conforme alle norme EN 12373, UNI EN ISO 2360. Frame in extruded aluminium (alloy EN AW-6060 physic state T6). Anodic oxidation according to EN 12373, UNI EN ISO 2360 rules.
2. Vetro singolo temperato spessore 4 mm in versione laccato, satinato e riflettente.
3. Guarnizione perimetrale in gomma siliconica. / Perimetral joint in silicon rubber.

Resistenza alla rottura conforme alle norme UNI EN 12150, UNI 7697 e UNI EN 12600. Single tempered glass 4 mm thickness in lacquered, satin-finish, and reflecting versions. Resistant to crashes according to UNI EN 12150, UNI 7697 and UNI EN 12600 rules.

Resistente a urti e impatti secondo le norme UNI EN 12150, UNI 7697 e UNI EN 12600.

## Descrizione tecnica Technical description

I pannelli scorrevoli Graphis plus e Graphis light vengono sempre realizzati su misura in altezza e larghezza, fino alle dimensioni massime indicate nello schema a fianco. Entrambi i sistemi sono caratterizzati dalla maniglia incassata in metallo, con inserto in vetro laccato in tinta con il pannello.

Graphis plus and Graphis light panels are always customized both in height and width up to the largest sizes specified in the side diagram. Both systems are characterised by a recessed metal handle with lacquered glass insert, that matches the panel.

Die Paneele Graphis Plus und Graphis Light werden immer nach Maß, sowohl in der Höhe als auch in der Breite, gearbeitet. Maximale verfügbaren Abmessungen laut seitlichem Schema. Kennzeichnend fuer beide Systeme ist der eingelassene Metallgriff mit lackertem Glaseinsatz in der Farbe der Tuerplatte.

Les panneaux coulissants Graphis plus et Graphis light sont toujours réalisés sur mesure en hauteur et largeur, jusqu'aux dimensions maximales indiquées sur le schéma à côté. Les deux systèmes sont caractérisés par la poignée encastrée en métal avec insert en verre laqué coordonné avec le panneau.

Los paneles correderos Graphis plus y Graphis light se realizan siempre a medida tanto en altura como en anchura, hasta las dimensiones máximas indicadas en el esquema de al lado. Los dos sistemas se caracterizan por el tirador empotrado de metal, con una aplicación de cristal lacado a juego con el panel.

## Dimensioni e maniglie Dimensions and handles

Dimensioni pannelli scorrevoli  
Sliding panel dimensions

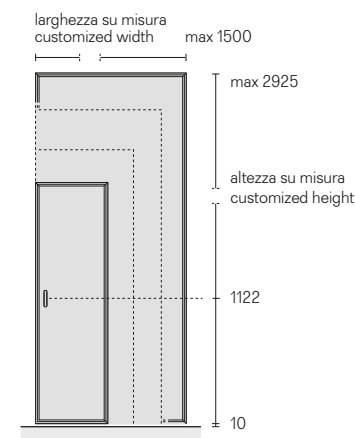

Maniglie graphis plus  
Handles graphis plus



1. 2163 maniglia. / 2163 handle.
2. 2163N maniglia con nottolino. / 2163N handle with revolving plug.
3. 9316 maniglia con serratura brevettata e chiave (per porte scorrevoli lineari). 9316 handle with patented lock and key (for linear sliding door).

Maniglia graphis light  
Handle graphis light

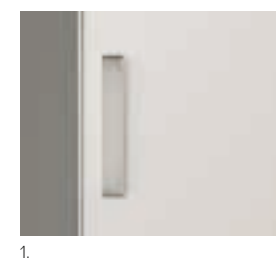

1. 2162 maniglia. / 2162 handle.



Design Giuseppe Bavuso

## Siparium

The original project of the Rimadesio's sliding doors systems, Siparium nowadays confirms the quality of the concept, updated during the years with a series of technical and aesthetical innovation, starting from the new rails with covering profiles to the most actual finishings for glasses and structures. A project that always proposes the folding and the swing version, which stands out for its design versatility.

Progetto originario della collezione di porte scorrevoli Rimadesio, Siparium conferma oggi tutta la qualità tipologica dell'idea, aggiornata nel tempo con una serie di innovazioni tecniche ed estetiche, dai nuovi binari con profili di copertura alle finiture più attuali di vetri e di struttura. Una proposta che da sempre prevede anche la versione con apertura a libro e che si distingue per la versatilità progettuale sia negli ambienti domestici che negli spazi professionali.

Das ursprünglich aus der Siparium Kollektion stammende Design der Rimadesio-Schiebetüren, bestätigt heute die gesamte typologische Qualität der Idee, die im Laufe der Zeit mit einer Reihe von technischen und ästhetischen Innovationen aktualisiert wurde und zwar von den neuen mit Abdeckprofilen versehenen Gleitschienen bis hin zu den aktuellsten Glas- und Strukturausführungen. Dieses Angebot ist seit jeher auch in der Version der Buchöffnung vorhanden und zeichnet sich sowohl im häuslichen als auch professionellen Bereich durch ihre gestalterische Vielseitigkeit aus.

Premier produit de la collection de panneaux coulissants Rimadesio, Siparium confirme aujourd'hui toute la qualité typologique de l'idée, mise à jour au fil du temps par une série d'innovations techniques et esthétiques, des nouvelles rails aux profilés de finition, jusqu'aux finitions les plus actuelles du verre et de la structure. Une proposition qui comprend aussi la version avec ouverture à livre et qui se caractérise par sa polyvalence de conception soit dans les environnements domestiques que dans les espaces professionnels.

El diseño original de la colección de paneles correderos Rimadesio, Siparium confirma hoy toda la calidad tipológica de la idea, actualizada en el tiempo con una serie de innovaciones técnicas y estéticas, de las nuevas guías con perfiles embellecedores a los acabados más actuales de vidrio y estructura. Una propuesta que desde siempre ha proporcionado la versión con apertura plegable y que destaca por su versatilidad de diseño tanto en entornos domésticos como en espacios profesionales.

Pannelli con apertura a libro *Folding door version*  
 Struttura e maniglia *Structure and handle*: 304 platino  
 Vetro *Glass*: 61 rete inox  
 Binario *Rail*: 30 alluminio



La continua evoluzione tecnologica Rimadesio ha prodotto un meccanismo per l'apertura a libro dotato di superiori prestazioni funzionali. Il carrello di scorrimento e tutti i componenti del sistema sono pensati per garantire movimenti leggeri e silenziosi.

Rimadesio's ongoing technological evolution has created in a folding mechanism with higher functional performance. The sliding carriage and all the system's components are developed to guarantee light and silent movements.

Durch kontinuierliche technologische Weiterentwicklung hat Rimadesio einen Falttür-Mechanismus von höchster Funktionsfähigkeit herausgebracht. Die Rollwagen und alle die Systemkomponenten sind konzipiert worden, um leichte und leise Bewegungen zu gewährleisten.

L'éternelle évolution technologique Rimadesio a produit un mécanisme à ouverture pliante, équipé de fonctionnalités supérieures. Le chariot de coulissement ainsi que tous les composants du système sont pensés pour garantir des mouvements légers et silencieux.

La continua evolución tecnológica de Rimadesio ha ideado un mecanismo para la apertura libro dotado de prestaciones funcionales superiores. El carril y todos los componentes del sistema son ideados para garantizar movimientos suaves y silenciosos.





**Caratteristiche tecniche esclusive**  
Exclusive technical features



1. Struttura in alluminio estruso (lega EN AW-6060) in finitura brown. / Extruded aluminium frame (alloy EN AW-6060) in brown finishing.
2. Vetro temperato singolo spessore 6 mm oppure vetro stratificato spessore 3+3 mm. / Tempered single 6 mm thick glass or 3+3 mm laminated glass.
3. Guarnizione verticale in materiale plastico coestruso. Vertical seal in coextruded plastic material.

**Tipologie estetiche**  
Aesthetic typologies

Pannello a specchiatura intera  
Full height glass panel

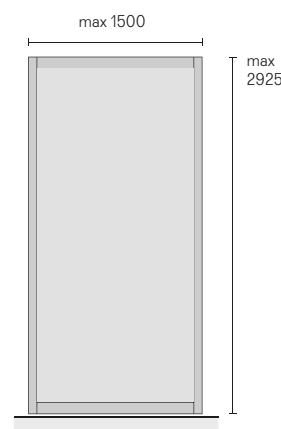

Pannello con traverso centrale  
Panel with central crosspiece

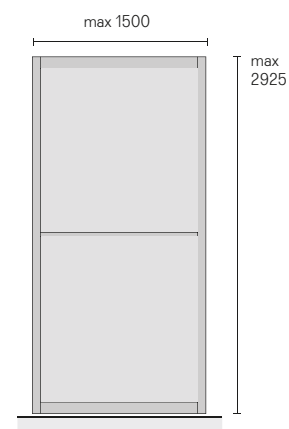

Pannello con due traversi orizzontali  
Panel with two horizontal crosspieces

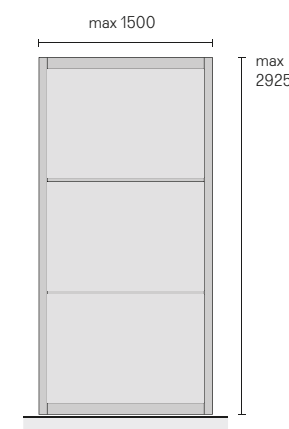

Pannello con tre traversi orizzontali  
Panel with three horizontal crosspieces

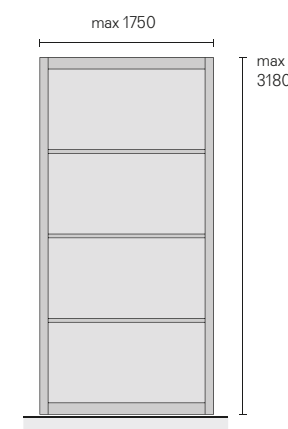

**Descrizione tecnica**  
Technical description

I pannelli scorrevoli Siparium vengono sempre realizzati su misura in altezza e larghezza, fino alle dimensioni massime indicate nello schema a fianco. Siparium è disponibile in quattro tipologie estetiche: pannello a specchiatura intera, con un traverso centrale, con due o tre traversi equidistanti.

Siparium panels are always custom made in height and width according to the dimensions indicated on the side on the scheme. Siparium is available with four esthetic typologies: full height glass panel, central crosspiece, two or three equidistant crosspieces.

Siparium Paneele sind immer nach Mass in Hoehe und Breite hergestellt. Siehe Maximal-Masse, die seitlich angegeben sind. Siparium ist mit vier aesthetischen Typologien verfuegbar: Paneel ohne Sprossen, Paneel mit mittlerem Sprosse, Paneel mit Zwei oder drei gleichabstaendigen Sprossen.

Les panneaux Siparium sont réalisés toujours sur mesure soit en hauteur qu'en largeur, selon les dimensions maximales indiquées de côté dans le plan. Siparium est disponible dans quatre typologies esthétiques: panneau sans traverses, panneau avec traverse centrale, panneau avec deux ou trois traverses équidistantes.

Los paneles Siparium se realizan siempre a medida en altura y anchura, hasta las dimensiones máximas indicadas en el esquema de al lado. Siparium es disponible en cuatro tipologías estéticas: panel sin transversal, con un transversal central, con dos o tres transversales equidistantes.

**Dimensioni e maniglie**  
Dimensions and handles

Dimensioni pannelli scorrevoli  
Sliding panel dimensions

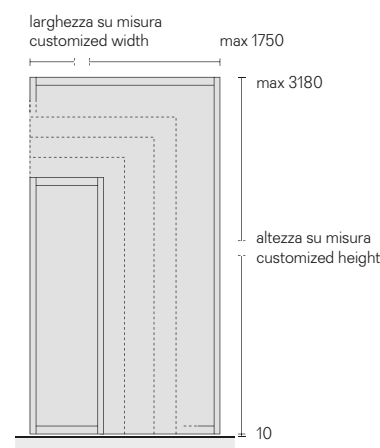

Dimensioni pannelli a libro e battenti  
Folding and swing panel dimensions

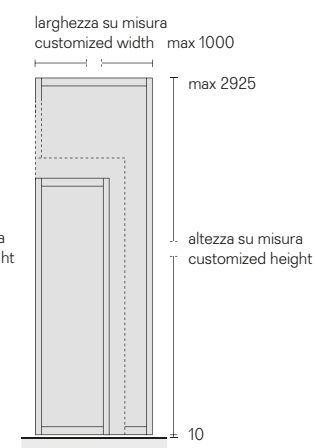

**Maniglie**  
Handles

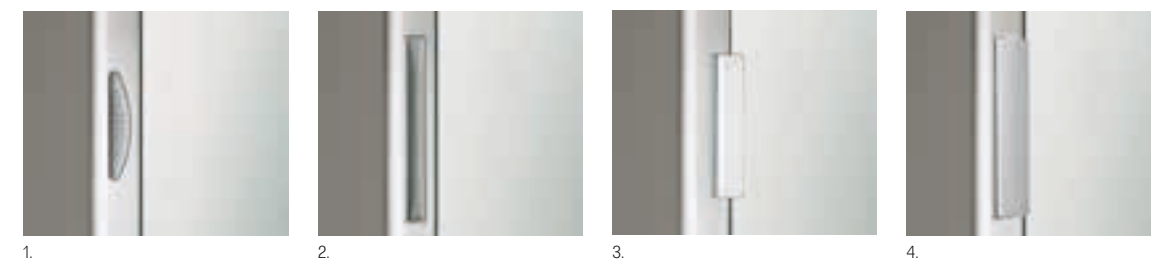

1. 727 maniglia ad incasso. 727 inset handle.
2. 1090 maniglia ad incasso. 1090 inset handle.
3. 773 maniglia rettangolare. 773 rectangular handle.
4. 913 maniglia piega. / 913 fold handle.

# Doors

149 Zen, Zen frame, 163 Sail, 171 Moon, 185 Luxor,  
193 Vela, 203 Aura, 209 Even, 215 Spin, 221 Link +



Design Giuseppe Bavuso

## Zen, Zen frame

Available in the swing and pocket version, Zen is characterized by the simple design of the frame. In the swing version, the door is available flush to the wall with both options of push and pull opening. Always custom made in height, Zen can perfectly integrate with the architecture of the environments, creating original solutions of “total height”. Compared to Zen, Zen frame is characterized by the simple assembling of the adjustable jamb.

Prevista nella versione battente e scorrevole, Zen è caratterizzata dall'essenzialità del disegno del telaio. La versione battente consente inoltre la possibilità di installazione con senso di apertura a tirare o spingere. Sempre su misura, Zen è in grado di integrarsi perfettamente con l'architettura degli ambienti, creando soluzioni "a tutta altezza" di forte originalità. Zen Frame si distingue da Zen per la semplicità di montaggio del copristipite regolabile.

Zen zeichnet sich durch das essentielle Design des Türrahmens aus und ist in der Schwing- und Schiebeversion vorhanden. Die Erstere ermöglicht auch die Bestimmung der Öffnungsrichtung (durch Ziehen oder Schieben) während der Installation. Die maßgeschneiderte Zen Linie fügt sich perfekt in die Architektur der Räume ein und schafft so hochwertige Lösungen mit hoher Originalität. Zen Frame unterscheidet sich von Zen aufgrund der Einfachheit der Montage der verschiedenen verstellbaren Rahmen.

Disponibile dans la version battante et coulissante, Zen se caractérise par le design essentiel de la structure. La version battante permet une installation avec ouverture à tirer ou à pousser. Toujours sur mesure, Zen s'intègre parfaitement à l'architecture des pièces, en créant des solutions de haute qualité avec un haut niveau d'originalité. Zen Frame diffère du Zen, grâce à la simplicité d'assemblage de son jambage télescopique.

Disponibile en la versión batiente y corredera, Zen se caracteriza por el la esencialidad del diseño del marco. La versión batiente también permite la posibilidad de instalación con dirección de apertura a tirar o empujar. Siempre a medida, Zen es capaz de integrarse perfectamente con la arquitectura de las habitaciones, creando soluciones "a toda altura" de gran originalidad. Zen Frame se distingue del Zen por la simplicidad de montaje de los diferentes marcos ajustables.







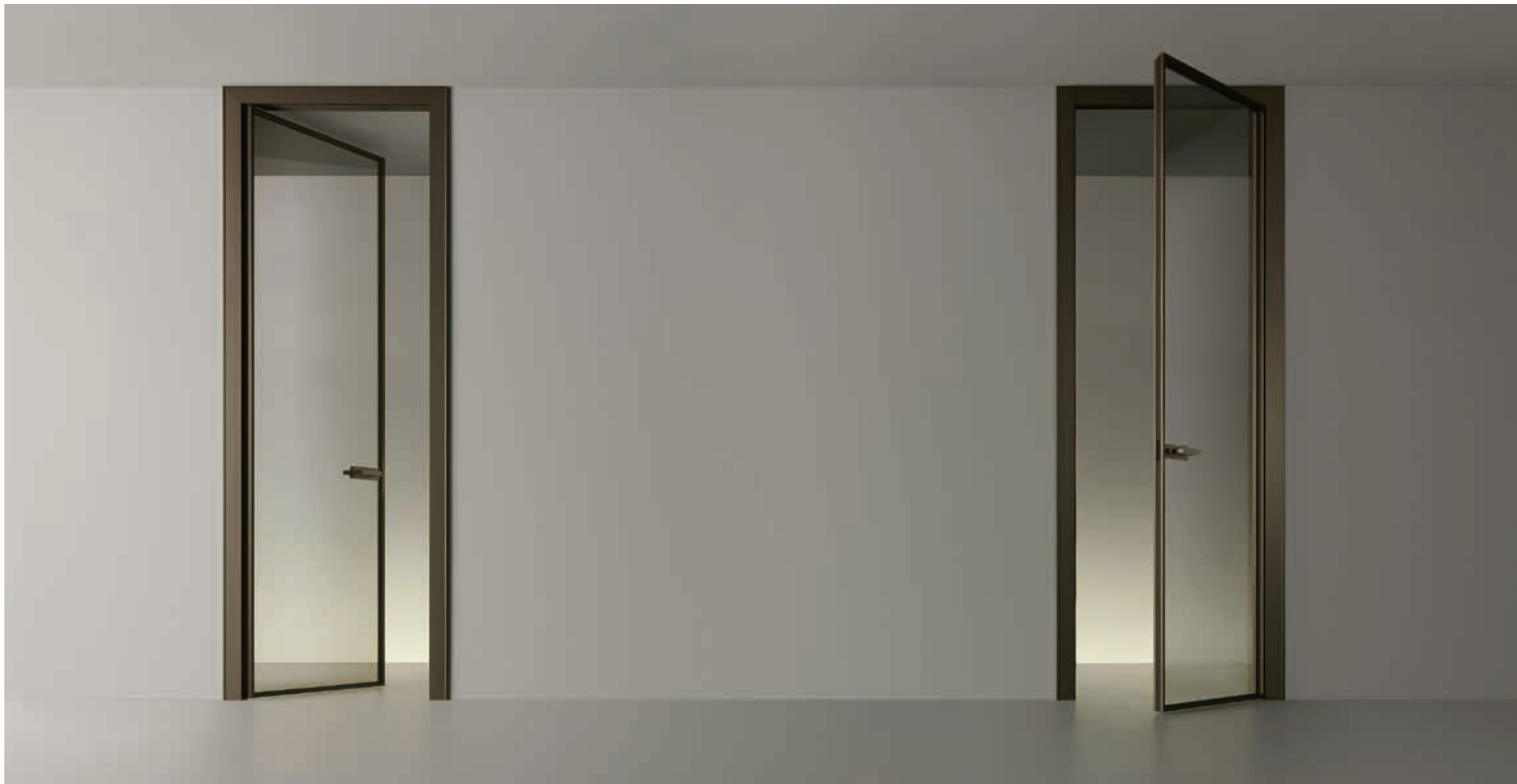



Porta con apertura a tirare  
Door with pull opening



Destra / Right

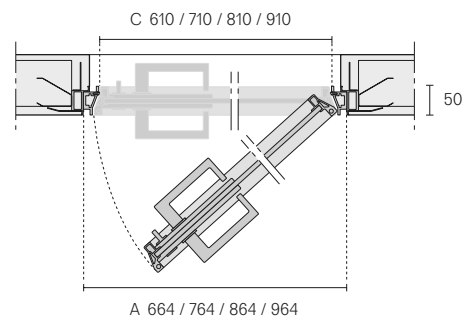

Sinistra / Left

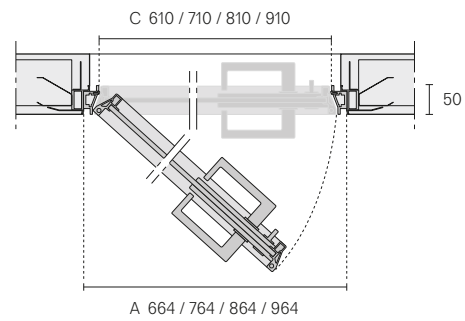

Descrizione tecnica  
Technical description

Le porte coplanari Zen consentono la possibilità di apertura a spingere o a tirare, garantendo la massima libertà progettuale. Il profilo a "s" elimina la battuta nell'accoppiamento tra pannello e stipite. Il falso telaio interamente in alluminio garantisce una perfetta installazione della porta su parete in muratura e su cartongesso.

Zen flush doors can be opened by pushing or pulling, offering the maximum customizable design. Characterized by "s" shaped profile, which removes the edging profile where the door panel meets the jamb. The aluminum subframe allows perfect installation both on brick wall and plasterboard.

Die Drehtüren Zen können entweder zum "drücken" oder "ziehen" geöffnet werden. Das S-förmige Profil charakterisiert die Tür Zen, und eliminiert den Übergang in der Befestigung zwischen Türblatt Rahmen. Die Tür ist sowohl in Standarddimensionen als auch in Sondermaßen erhältlich. Der Blindstock aus Aluminium garantiert eine perfekte Montage bei Ziegelmwänden sowie Gipskarton.

Les portes coplanaires Zen permettent la possibilité d'ouverture en poussant ou en tirant, assurant un maximum de liberté dans le projet. Caractérisé par le profil à "s", qui ne nécessite pas de retour de jambage sur le mur. Le faux châssis en aluminium garantit une parfaite installation de la porte sur le mur en brique et de placo-plâtre.

Las puertas coplanares Zen permiten la posibilidad de abrir empujando o tirando, que garantiza la máxima libertad de diseño. Caracterizada por el perfil a "S" que elimina la golpe en la unión entre el panel y la jambam. El premarco de enteramente en aluminio garantiza una perfecta instalación de la puerta en el muro de ladrillo o pladur.

Porta con apertura a spingere  
Door with push opening



Destra / Right

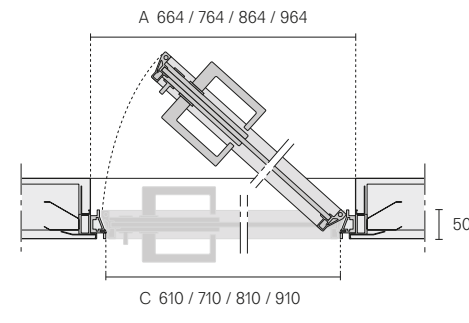

Sinistra / Left

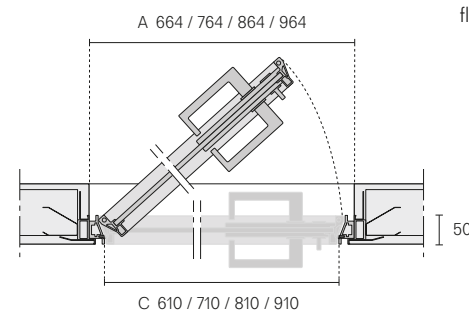

Porta battente filo parete / Swing wall flush door

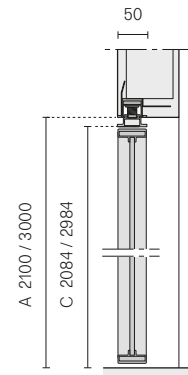

Porta battente filo parete raso soffitto / Swing wall flush and flushceiling door

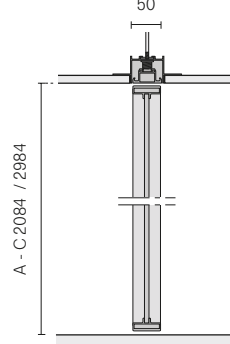

Porta scorrevole per controtelai / Pocket door for systems  
Scrigno® Essential, Eclisse® Syntesis® line



La versione battente è prevista nelle dimensioni standard o su misura, fino all'altezza massima di 3000 mm. Swing doors version is available in standard measures or can be custom-made, with a maximum height of 3000 mm.

Nella versione scorrevole, prevista sempre su misura fino all'altezza massima di 2700 mm, lo stipite telescopico mini prevede un montaggio ad incastro senza viti e giunzioni a vista. In the pocket version, always custom made in height up to 2700 mm, the telescopic mini jamb is provided with snap-fit closure without visible screws or joints.

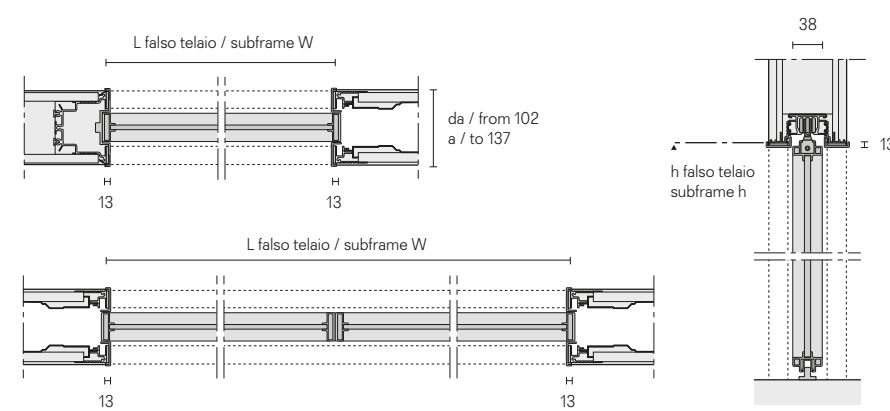

A. Luce netta falso telaio / Measure of the subframe  
C. Luce netta passaggio / Dimensions of the opening

Maniglie  
Handles



TR06C con chiave. / With key.



TR06 con nottolino. With revolving plug.



2093 con nottolino. With revolving plug.



2005 maniglia. / Handle.



3205 maniglia. / Handle.

Porta con apertura a tirare  
Door with pull opening



Destra / Right

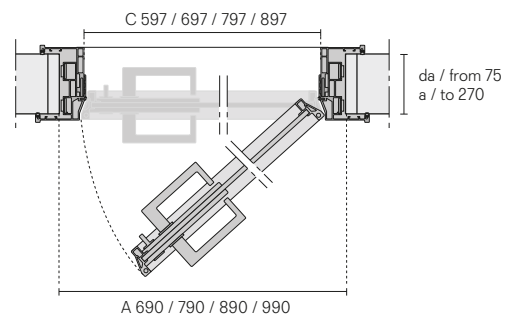

Sinistra / Left

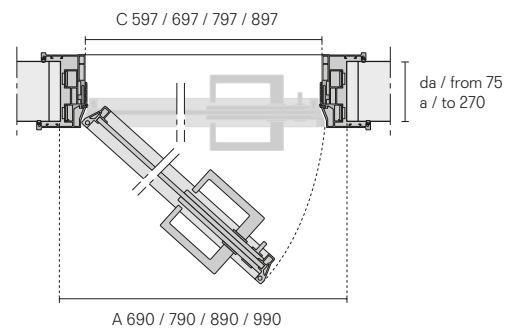

Descrizione tecnica  
Technical description

Lo stipite con sezione a "s" caratterizza Zen frame e permette l'installazione della porta con senso di apertura a spingere o a tirare. La guarnizione di battuta in silicone, dotata di memoria elastica, garantisce un movimento di chiusura ammortizzato e silenzioso. Nella versione scorrevole Zen frame è dotata di uno stipite telescopico con montaggio ad incastro.

The "s" shaped jamb characterizes Zen frame and allows the door installation for pushing or pulling opening. The perimetral joint in silicone rubber, with an extraordinary elastic memory, ensures a perfectly silent and cushioned closing movement. Zen frame pocket version has a telescopic jamb with snap-fit assembly.

Dank Ihres S-förmigen Profils können die Drehtüren Zen frame entweder zum "drücken" oder zum "ziehen" geöffnet werden. Die Silikonreibbelag ermöglicht eine lautlose Benutzung der Tür. Die Schiebeversion der Tür Zen frame hat einen teleskopischen Pfosten der verklemmt wird.

Le jambage à "s" de Zen frame permet l'installation avec ouverture à pousser ou à tirer. Le joint de butée de silicone, doté d'une mémoire élastique exceptionnelle, garantit un mouvement de fermeture amortie et silencieux. Zen frame dans la version galvanisée est équipé avec jambage télescopique avec fixation à encastrement.

La jamba con la sección a "S" caracteriza Zen frame permite una la instalación de la puerta con sentido de apertura a empujar o a tirar. La goma de silicona, dotada de una memoria elástica, garantiza un movimiento de cierre amortiguado y silencioso. En la versión corredera Zen frame está dotada de una jamba telescópica con montaje a encastré.

Porta con apertura a spingere  
Door with push opening



Destra / Right

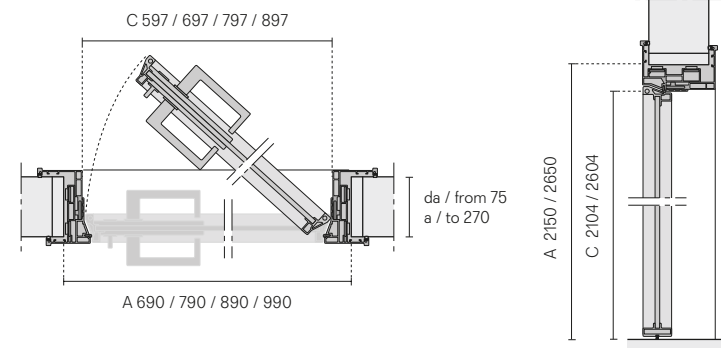

Sinistra / Left

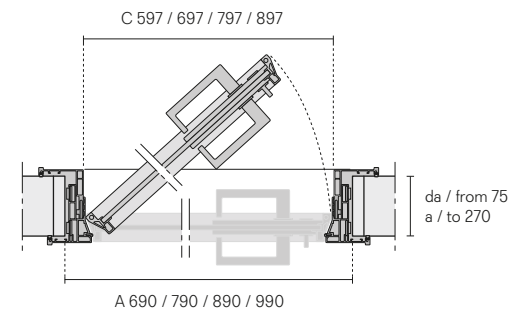

Porta scorrevole per controtelai a scomparsa  
Pocket door



Zen frame è prevista nelle dimensioni standard o su misura, fino all'altezza massima di 2650 mm. / Zen frame is available in standard measures or can be custom-made, with a maximum height of 2650 mm.

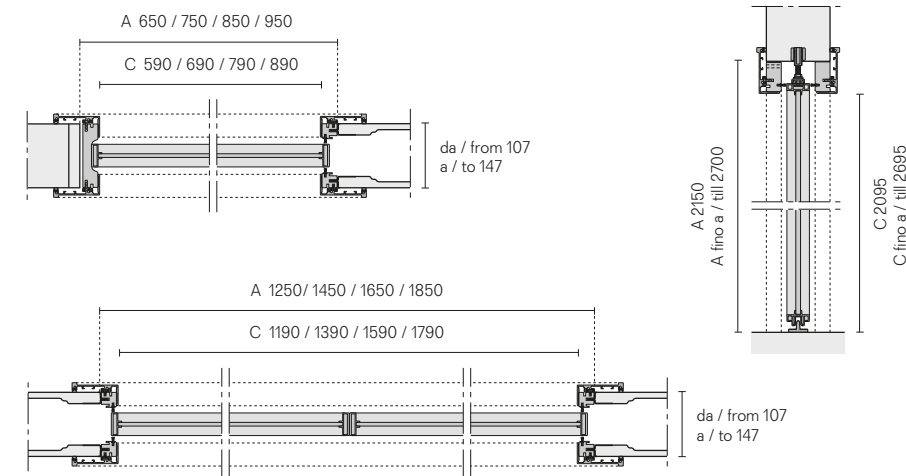

A. Luce netta falso telaio / Measure of the subframe  
C. Luce netta passaggio / Dimensions of the opening

Maniglie  
Handles



TR06C con chiave. / With key.



TR06 con nottolino. / With revolving plug.



2093 con nottolino. / With revolving plug.



2005 maniglia. / Handle.



3205 maniglia. / Handle.



Design Giuseppe Bavuso

## Sail

Sail combines high technical and functional performance with an original aesthetic and a strong expressive value. Result of a careful technological research and of an elaborate manual assembling work of the components, Sail becomes a real decorative item. Endless combining solutions between Rimadesio glass finishes and the aluminium structural element, also available in walnut or heat-treated oak veneered version.

Sail associa alte prestazioni tecniche e funzionali a un'estetica originale e dal forte valore espressivo. Risultato di un'attenta ricerca tecnologica e di un complesso lavoro manuale nell'assemblaggio dei componenti, Sail si propone come un vero e proprio elemento d'arredo. Infinite le soluzioni di abbinamento tra le finiture dei vetri Rimadesio e l'alluminio degli elementi strutturali, disponibili anche nella versione rivestita in noce o rovere termotrattato.

Sail kombiniert hohe technische und funktionale Lösungen mit einer einzigartigen Ästhetik und einem starken Ausdruckswert. Nach sorgfältiger technologischer Recherche und aufwändiger Handarbeit bei der Montage der Komponenten präsentiert sich Sail als echtes Einrichtungselement. Sail bietet unendlich passende Lösungen mit den Rimadesio Glasoberflächen und den Aluminiumstrukturelementen. Sail ist auch in einer Version verkleidet mit Nussbaum oder thermobehandelter Eiche erhältlich.

Sail associe des performances techniques et fonctionnelles à une esthétique originale et une forte valeur expressive. Fruit d'une recherche technologique minutieuse et d'un travail manuel complexe dans l'assemblage des composants, Sail se présente comme un véritable élément d'ameublement. Des solutions infinies de combinaisons entre les finitions des verres Rimadesio et l'aluminium des éléments structurels, disponibles aussi dans la version revêtue en noyer et chêne thermo traité.

Sail combina un alto rendimiento técnico y funcional con una estética original y un fuerte valor expresivo. Resultado de una cuidadosa investigación tecnológica y de un complejo trabajo manual en el ensamblaje de los componentes, Sail se presenta como un elemento de mobiliario real. Infinitas soluciones de combinación entre los acabados de vidrio Rimadesio y el aluminio de los elementos estructurales, también disponibles en una versión en nogal o roble termotrattado.

Porta battente e porta scorrevole  
Swing door and sliding door  
Struttura Structure: 19 rovere termotrattato  
Vetro Glass: 67 riflettente chiaro  
Stipiti e maniglia Jambs and handle: 303 bronzo

Nella foto In this photo  
Sistema interparete  
Wall partition system: Spazio

Doors





Porta con apertura a tirare  
Door with pull opening

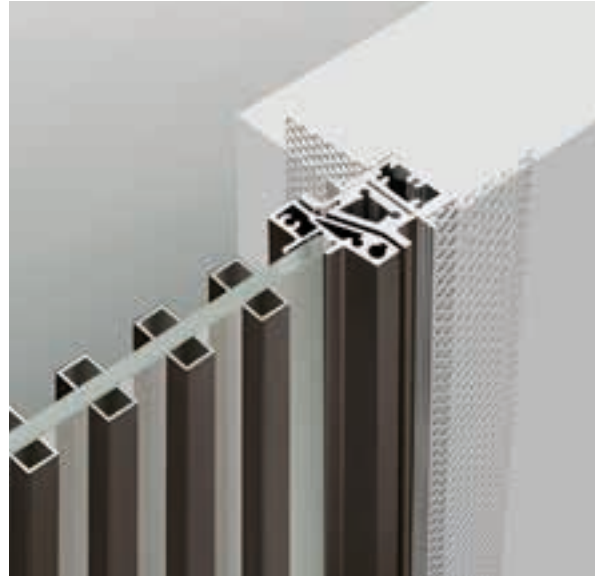

Destra / Right

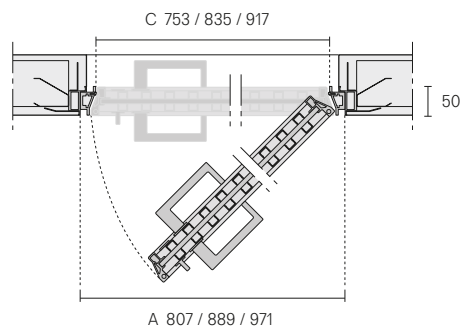

Sinistra / Left

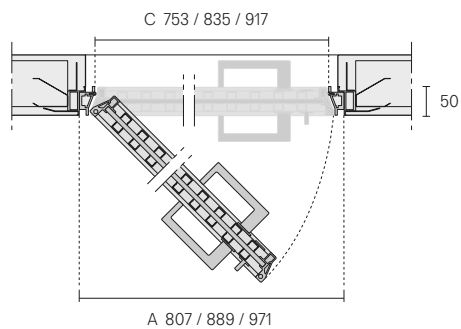

Descrizione tecnica  
Technical description

Le porte coplanari Sail consentono la possibilità di apertura a spingere o a tirare, garantendo la massima libertà progettuale. Il profilo a "s" elimina la battuta nell'accoppiamento tra pannello e stipite. Il falso telaio interamente in alluminio garantisce una perfetta installazione della porta su parete in muratura e su cartongesso.

Sail flush doors can be opened by pushing or pulling, offering the maximum customizable design. Characterized by "s" shaped profile, which removes the edging profile where the door panel meets the jamb. The aluminum subframe allows perfect installation both on brick wall and plasterboard.

Die Drehtüren Sail können entweder zum "drücken" oder "ziehen" geöffnet werden. Das S-förmige Profil charakterisiert die Tür Zen, und eliminiert den Übergang in der Befestigung zwischen Türblatt Rahmen. Die Tür ist sowohl in Standarddimensionen als auch in Sondermaßen erhältlich. Der Blindstock aus Aluminium garantiert eine perfekte Montage bei Ziegelmwänden sowie Gipskarton.

Les portes coplanaires Sail permettent la possibilité d'ouverture en poussant ou en tirant, assurant un maximum de liberté dans le projet. Caractérisé par le profil à "s", qui ne nécessite pas de retour de jambage sur le mur. Le faux châssis en aluminium garantit une parfaite installation de la porte sur le mur en brique et de placo-plâtre.

Las puertas coplanares Sail permiten la posibilidad de abrir empujando o tirando, que garantiza la máxima libertad de diseño. Caracterizada por el perfil a "S" que elimina la golpe en la unión entre el panel y la jambam. El premarco de enteramente en aluminio garantiza una perfecta instalación de la puerta en el muro de ladrillo o pladur.

Porta con apertura a spingere  
Door with push opening

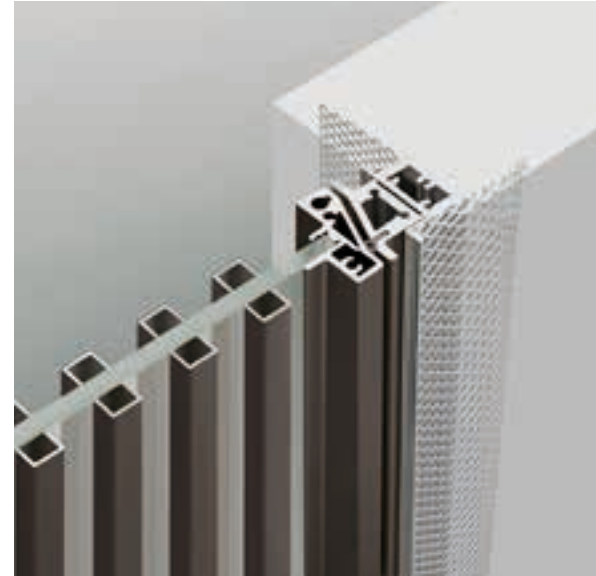

Destra / Right

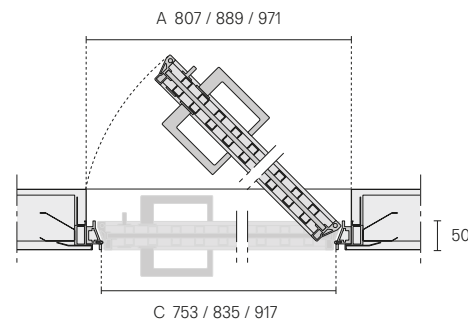

Sinistra / Left

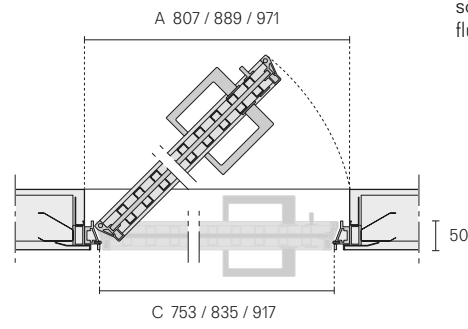

Porta battente filo parete / Wall flush swing door

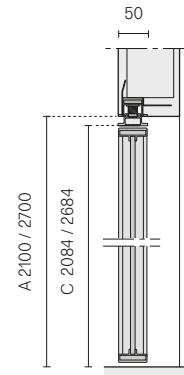

Porta battente filo parete raso soffitto / Wall flush and flushceiling swing door

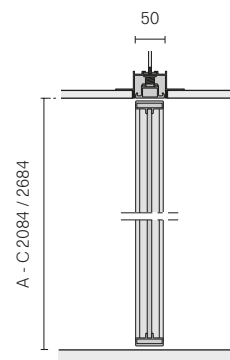

Porta scorrevole per controtelai / Pocket door for systems  
Scrigno® Essential, Eclisse® Syntesis® line



La versione battente è prevista nelle dimensioni standard o su misura, fino all'altezza massima di 2700 mm. The swing door version is available in standard dimensions or can be custom made, with a maximum height of 2700 mm.

Nella versione scorrevole, prevista sempre su misura fino all'altezza massima di 2700 mm, lo stipite telescopico mini prevede un montaggio ad incastro senza viti e giunzioni a vista. In the pocket version, always custom made in height up to 2700 mm, the telescopic mini jamb is provided with snap-fit closure without visible screws or joints.

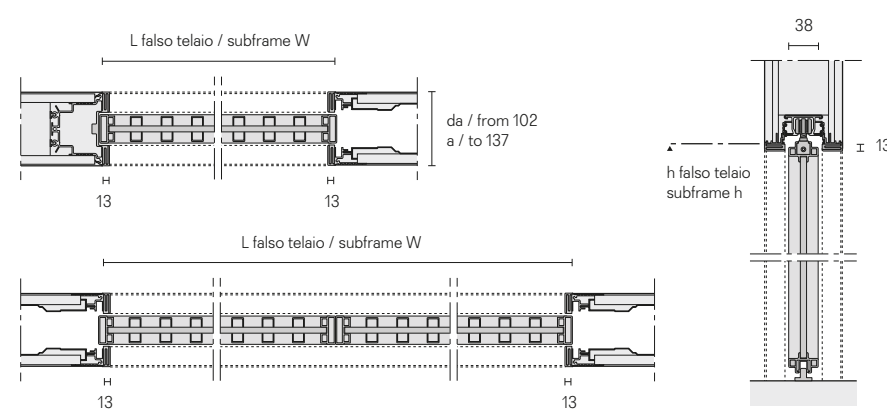

A. Luce netta falso telaio / Measure of the subframe  
C. Luce netta passaggio / Dimensions of the opening

Maniglie  
Handles



1. TR07C con chiave. / With key.
2. TR07 con nottolino. With revolving plug.
3. 2015



Design Giuseppe Bavuso

## Moon

Moon is the coplanar door of the Rimadesio collection. A project that realizes the total integration between doors and walls, between furniture elements and interior architecture. A quality as result of the particular profiles, removing the edging profile where the door panel meets the jamb. In the hinged version, the door is available flush to the wall with both options of push and pull opening. Always custom made in height, Moon spreads his best aesthetical value in the “total height” solution.

Moon è la porta complanare Rimadesio. Un progetto che realizza l'integrazione totale fra porta e pareti, fra elementi d'arredo e architettura d'interni. Una qualità che deriva dal particolare profilo che elimina la battuta nell'accoppiamento tra pannello e stipite e che permette, nella versione battente, la libera installazione con apertura a spingere o tirare. Sempre su misura, Moon esprime il suo massimo valore estetico nelle soluzioni "a tutta altezza".

Moon ist die flächenbündige Rimadesio-Tür. Ein Projekt, das die komplette Integration zwischen Tür und Wänden, zwischen Möbelementen und Innenarchitektur realisiert. Eine profilleigene Besonderheit ist einerseits die Beseitigung des Aufpralls zwischen Paneel und Türpfosten und die Möglichkeit die Scharnerversion so zu installieren, dass die Tür sowohl durch Drücken als auch durch Ziehen geöffnet werden kann. Moon erhält seinen maximalen ästhetischen Wert in der Version, in der die gesamte Raumhöhe genutzt wird.

Moon est la porte coplanaire Rimadesio. Un projet qui réalise une intégration totale entre porte et murs, entre éléments de mobilier et architecture d'intérieur. Une qualité qui découle du profil particulier, qui élimine la bague dans le couplage entre le panneau et le jambage et qui permet, dans la version battante, l'installation libre avec ouverture à pousser ou à tirer. Toujours sur mesure, Moon exprime sa valeur esthétique maximale dans les solutions "à toute hauteur".

Moon es la puerta coplanar de Rimadesio. Un proyecto que realiza la integración total entre puerta y paredes, entre elementos de mobiliario y arquitectura de interiores. Una calidad que se deriva del perfil particular que elimina el golpe en la unión entre el panel y la jamba y que permite, en la versión batiente, la instalación libre con apertura a empujar o tirar. Siempre a medida, Moon expresa su máximo valor estético en soluciones a "toda altura".

Struttura Structure: 304 platino  
Pannello porta Door panel: G001 gres crema  
Maniglia con inserto in tinta al pannello  
Handle with insert matching the panel











Porta con apertura a tirare  
Door with pull opening



Destra / Right

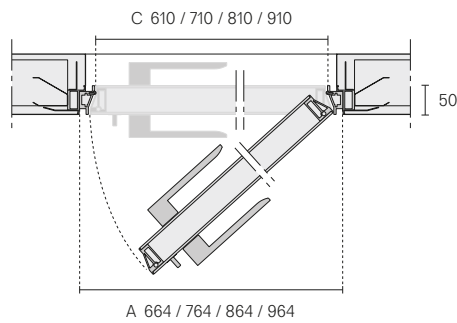

Sinistra / Left

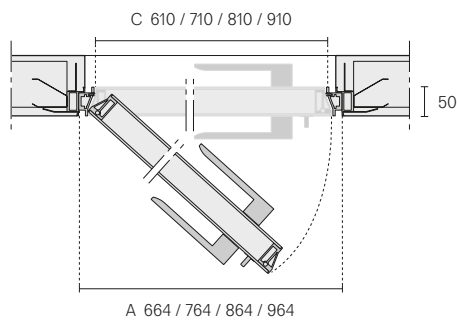

Porta con apertura a spingere  
Door with push opening



Destra / Right

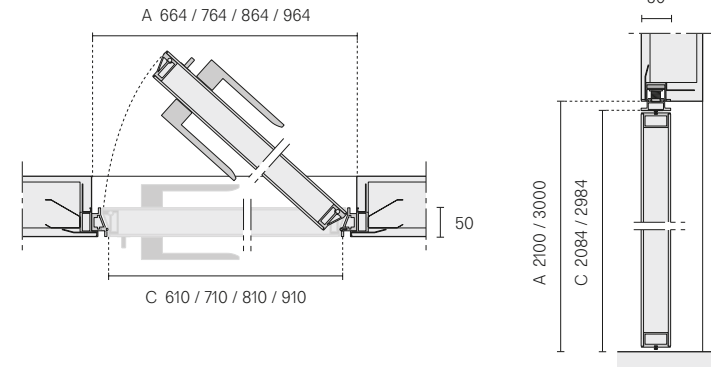

Sinistra / Left

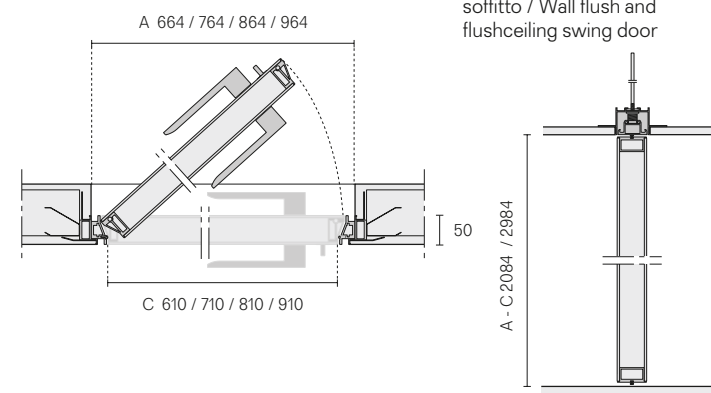

Porta scorrevole per controtelai / Pocket door for systems  
Scrigno® Essential, Eclisse® Syntesis® line



1.

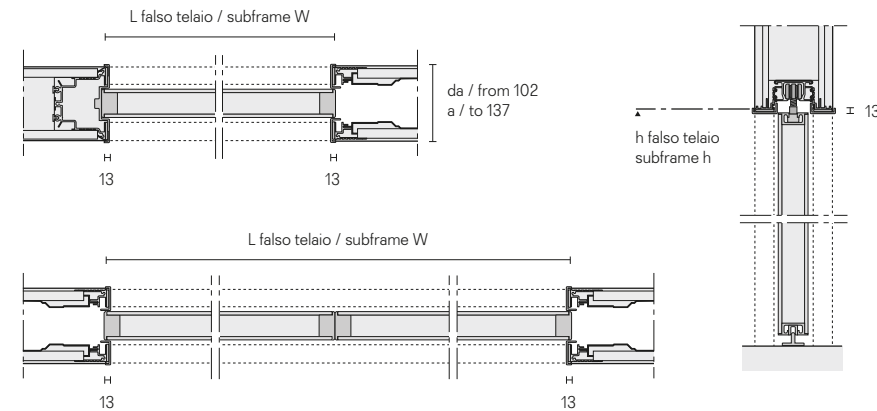

A. Luce netta falso telaio / Measure of the subframe  
C. Luce netta passaggio / Dimensions of the opening

Descrizione tecnica  
Technical description

Una delle caratteristiche più innovative della porta filo parete Moon è la possibilità di prevedere l'installazione con senso di apertura a tirare oppure a spingere. Il profilo con sezione a "s" elimina la battuta nell'accoppiamento tra pannello e stipite. Il falso telaio, interamente in alluminio, garantisce una perfetta installazione della porta su parete in muratura e su cartongesso.

One of the most innovative characteristics of Moon flush door is the possibility to install the door with opening by pushing or pulling. The "s" shaped profile removes the edging profile where the door panel meets the jamb. The aluminum subframe allows perfect installation both on brick wall and plasterboard.

Eine der innovativsten Charakteristiken der flächenbündigen Tür Moon ist die Möglichkeit die Tür entweder zum "drücken" oder zum "ziehen" geöffnet werden. Das S-Profil eliminiert den Anschlag zwischen Panel und Türstock. Das Blindstock ist komplett aus Aluminium und ist sowohl für Ziegelwände als auch für Gipskarton Wände geeignet.

Une des caractéristiques les plus innovantes de la porte à fleur Moon est la possibilité d'installation avec ouverture à tirer ou à pousser. Le profil à "s" élimine la butée entre le jambage et le panneau. Le faux-châssis, totalement en aluminium, garantit une installation parfaite de la porte sur brique et placo-plâtre.

Una de las características más innovadoras de la puerta coplanar Moon es la posibilidad de dotar la instalación con un sentido de apertura a tirar o a empujar. El perfil con sección de "S" elimina el golpe en el acoplamiento entre el panel y la jamba. El premarco íntegramente en aluminio, garantiza una perfecta instalación de la puerta en el muro de ladrillo o pladur.

Moon è prevista nelle dimensioni standard o su misura, fino all'altezza massima di 3000 mm. Moon is available in standard dimensions or can be custom made, with a maximum height of 3000 mm.

1. Nella versione scorrevole lo stipite mini prevede un montaggio ad incastro senza viti e giunzioni a vista. In the pocket version the mini jamb is provided with snap-fit closure without visible screws or joints.

**Porta doppia battente con apertura a tirare**  
**Double swing door with pull opening**

Destra / Right

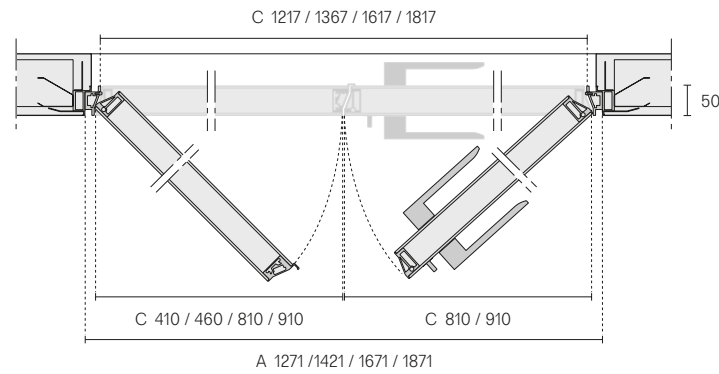

Sinistra / Left

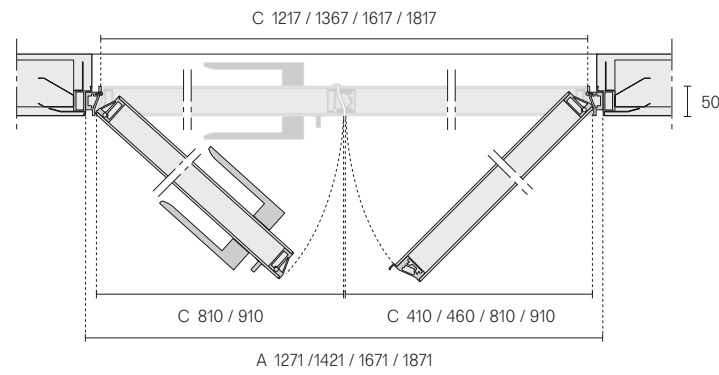

**Porta battente filo parete**  
**Wall flush swing door**

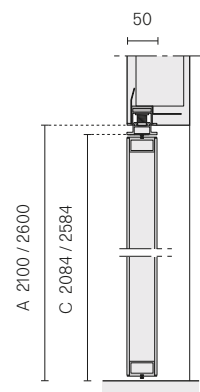

A. Luce netta falso telaio / Measure of the subframe  
 C. Luce netta passaggio / Dimensions of the opening

**Porta doppia battente con apertura a spingere**  
**Double swing door with push opening**

Destra / Right

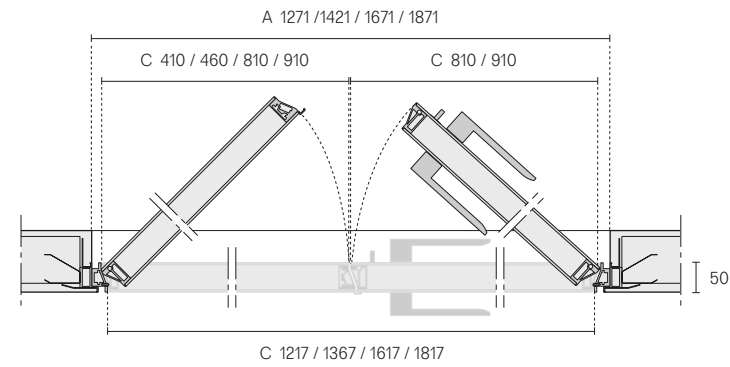

Sinistra / Left

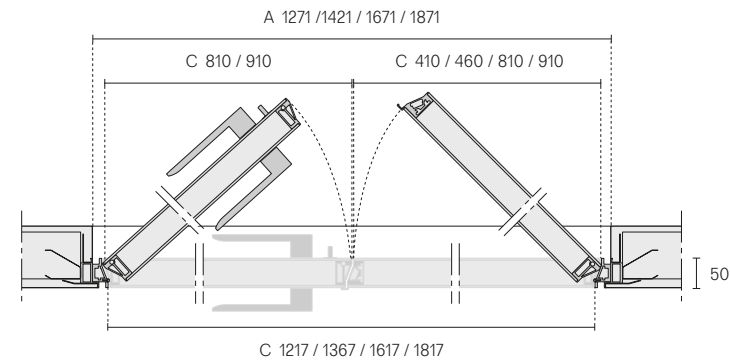

**Porta battente filo parete raso soffitto**  
**Wall flush and flushceiling swing door**

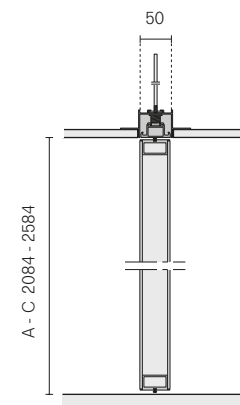

**Tipologie estetiche**  
**Aesthetic typologies**

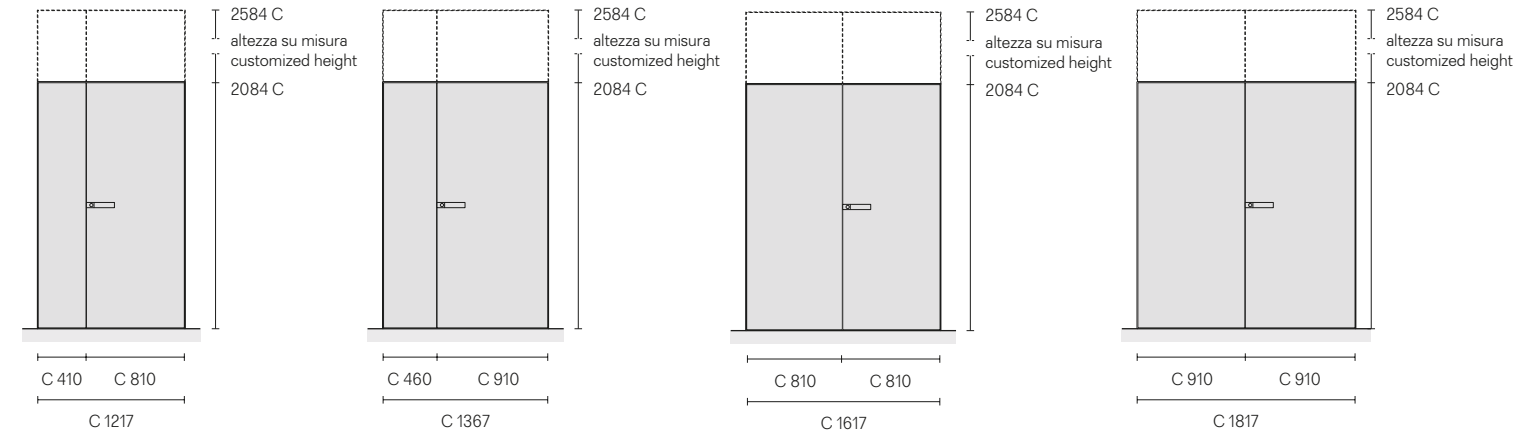

**Descrizione tecnica**  
**Technical description**

Disponibile anche nella versione a doppio battente e con l'inedito rivestimento in gres. Moon rappresenta una soluzione sempre più versatile ed esclusiva. Una porta che dal suo esordio concentra una lunga serie di innovazioni tecniche ed estetiche: la totale planarità con le pareti grazie al sottile profilo perimetrale, la particolare maniglia, resa mimetica dall'inserto nello stesso materiale, l'innovativo sistema di chiusura magnetico e un sistema di fissaggio brevettato per una sicura e funzionale chiusura del pannello fisso.

Now also available in the double swing version and with the new gres cladding finish, Moon is an increasingly versatile and exclusive solution. A door that, since the beginning, has concentrated a long series of technical and aesthetic innovations: the total flush-wall, thanks to its thin perimeter profile, the unique handle, made mimetic by the insert in the same material, the innovative magnetic closing system and a patented fastening system for a safe and functional closing of the fixed panel.

Ab heute ist die Version mit Doppelter Drehtüren und mit der neuartigen Ausführung in Gres (Feinsteinzeug) erhältlich. Die Türe Moon ermöglicht eine immer vielseitigere und exklusivere Lösung. Eine Türe die seit Anfang eine lange Serie von innovativen und ästhetischen Lösungen anbietet: Dank der feinen umlaufenden Profile ist der Einbau unsichtbar und mit dem eigenständige Türgriff, ergibt es einen kompletten Wand-und Deckenbündigen Einbau. Das innovative magnetische System für die Schliessung der Tür, ist eine patentierte, sichere und funktionale Lösung.

Disponible également dans la version double battante et avec la nouvelle finition en grès, Moon est une solution de plus en plus polyvalente et exclusive. Une porte qui depuis ses débuts concentre une longue série d'innovations techniques et esthétiques: la totale planarité avec les cloisons, grâce à un fin profil périmétral, l'exclusive poignée, camouflée par l'insert dans le même matériau, l'innovant système de fermeture magnétique et un système de fixation breveté pour une fermeture sûre et fonctionnelle du panneau fixe.

Ahora disponible también en la versión doble batiente y con el inédito revestimiento en gres, Moon representa una solución cada vez más versátil y exclusiva. Una puerta que desde su debut centra una larga serie de innovaciones técnicas y estéticas: la total planaridad con las paredes gracias al fino perfil perimetral, la particular manilla, hecha mimética por el inserto en el mismo material, el innovador sistema de cierre magnético y una sistema de fijación patentado para un cierre seguro y funcional del panel fijo.

**Maniglie**  
**Handles**

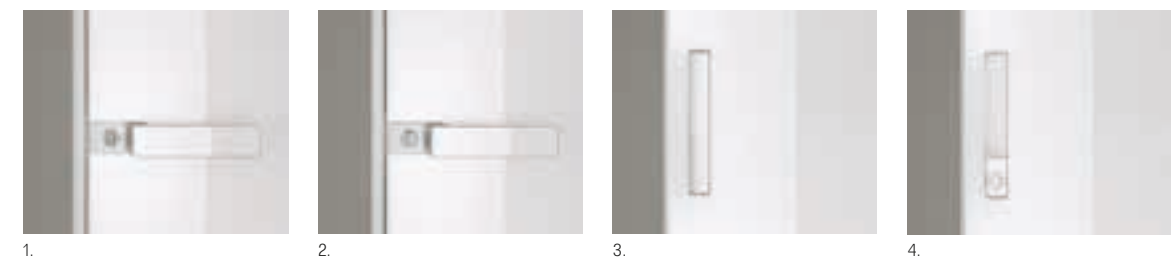

1. TR04C con chiave. / With key.
  2. TR04 con nottolino. / TR04 with revolving plug.
  3. 2163
  4. 2163N con nottolino. / With revolving plug.
- 2163C con chiave. / With key.



Design Giuseppe Bavuso

## Luxor

The coplanar Luxor swing door, with lacquered glass or leather jamb, is another solution of the Rimadesio collection for the projects, aiming at integrating as much as possible the elements in an overall coherent and stylistically defined vision. The customized door at full height, together with the panel totally flush to the wall, allows Luxor to suggest new solutions for the interior design.

La porta complanare Luxor, disponibile con finiture in vetro laccato e cuoio, è un'altra soluzione per i progetti della collezione Rimadesio, con lo scopo di integrare il più possibile tutti gli elementi in una visione stilisticamente ben definita. La versione su misura a tutta altezza, insieme alla totale coplanarità alla parete, consente a Luxor di proporre nuove soluzioni di design per gli interni.

Die koplanare Luxor-Drehtür mit lackiertem Glas oder Leder ist eine weitere Lösung der Rimadesio-Kollektion für die Projekte, deren Ziel es ist, die Elemente so weit wie möglich in eine kohärente und stilistisch definierte Vision zu integrieren. Die maßgefertigte Tür in voller Höhe, zusammen mit dem zur Wand bündigen Paneel, lässt Luxor neue Lösungen für die Innenarchitektur vorschlagen.

La porte battante coplanaire Luxor, avec jambage en verre laqué ou en cuir, est une autre solution de la collection Rimadesio pour les projets, visant à intégrer autant que possible les éléments dans une vision globalement cohérente et stylistiquement définie. La porte sur mesure à toute hauteur, ainsi que le panneau totalement aligné sur le mur, permet à Luxor de proposer de nouvelles solutions pour le design d'intérieur.

La puerta coplanar Luxor, con el vidrio lacado o el cuero, es otra solución de la colección Rimadesio para los proyectos, con el objetivo de incorporar tanto como sea posible los elementos en una visión global coherente y estilísticamente definida. La puerta a medida "a toda altura" junto con el panel totalmente enrasado a la pared permite Luxor sugerir nuevas soluciones para el diseño de interiores.



La porta coplanare Luxor, con stipite in vetro laccato, rappresenta un'altra soluzione che la collezione Rimadesio mette a disposizione di progetti che mirano ad integrare il più possibile gli elementi in una visione complessiva coerente e stilisticamente definita nei minimi dettagli.

The coplanar Luxor swing door, with lacquered glass jamb, is another solution of the Rimadesio collection for the projects, aiming at integrating as much as possible the elements in an overall coherent and stylistically defined vision.

Die Drehtür Luxor, mit Pfosten aus lackiertem Glas stellen eine andere Lösung dar, welche die Kollektion Rimadesio bietet um Projekte umzusetzen die versuchen die einzelnen Elemente auf eine Art einzusetzen, die die Vision von komplett abgestimmten und stilistisch definierten Elementen bis ins kleinste Detail umgesetzt.

La porte coplanaire Luxor, avec jambage en verre laqué, est une autre solution que la collection Rimadesio met à disposition des projets, qui cherchent à intégrer le plus possible les éléments dans un ensemble cohérent et stylistiquement défini dans les détails.

La puerta coplanar Luxor, con jamba en cristal lacado, representa otra solución que la colección Rimadesio ofrece entre proyectos que tienen como objetivo integrar en lo posible los elementos en un conjunto coherente y estilísticamente definido en detalle.





Porta con apertura a tirare  
Door with pull opening



Destra / right

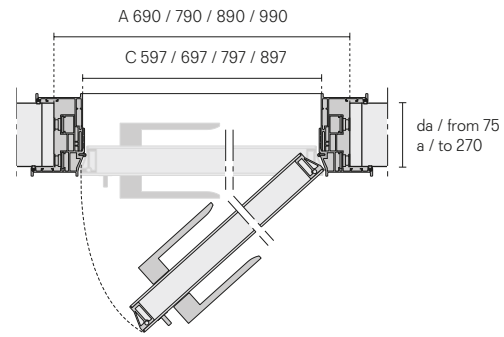

Sinistra / left

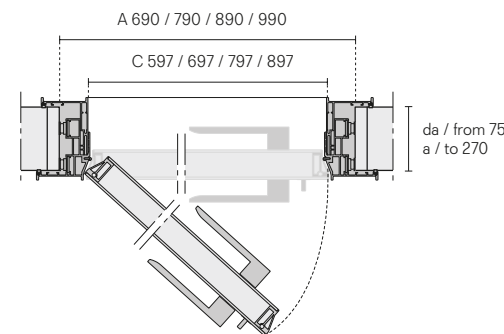

Descrizione tecnica  
Technical description

Luxor è dotata di uno stipite a "s" brevettato, che offre la possibilità di installare la porta con apertura a spingere oppure a tirare. La guarnizione di battuta in silicone, dotato di memoria elastica, garantisce un movimento di chiusura ammortizzato e silenzioso. Nella versione scorrevole il montaggio dello stipite in estruso di alluminio è ad incastro senza viti e giunzioni a vista.

Luxor has a patented "s" shaped jamb that allows the door installation for pushing or pulling opening. The perimetral joint in silicone rubber, with an extraordinary elastic memory, ensures a perfectly silent and cushioned closing movement. In the pocket version the ultra thin jamb is provided with snap-fit closure without visible screws or joints.

Die Tuer Luxor mit dem s-förmigem Profil, bietet die Moeglichkeit den Türanschlag zum "drücken" oder zum "ziehen". Die Silikon Gummidichtung garantiert eine amortisierte und geräuscharme Schliesung. Bei der Montage der Schiebetürversion wird der schmale Türpfosten aus extrudiertem Aluminium geklemmt und die Schrauben und Dichtungen sind nicht sichtbar.

Luxor est disponible avec un profil breveté à "s", qui permet l'installation avec ouverture à pousser ou à tirer. Le joint de butée de silicone, doté d'une mémoire élastique exceptionnelle, garantit un mouvement de fermeture amortie et silencieux. Dans la version galandage est équipé avec jambage télescopique en extrusion d'aluminium avec fixation à encastrement sans vis et joints visibles.

Luxor está dotada de una jamba a "s" patentada, que ofrece la posibilidad de instalar la puerta con apertura a empujar o a tirar. La guarnición de golpe en silicona, equipada con una memoria elástica, garantiza un movimiento de cierre amortiguado y silencioso. En la versión corredera en el muro el montaje de la jamba ultra fina en extruido de aluminio se realiza a encaje sin tornillos y juntas visibles.

Porta con apertura a spingere  
Door with push opening



Destra / right

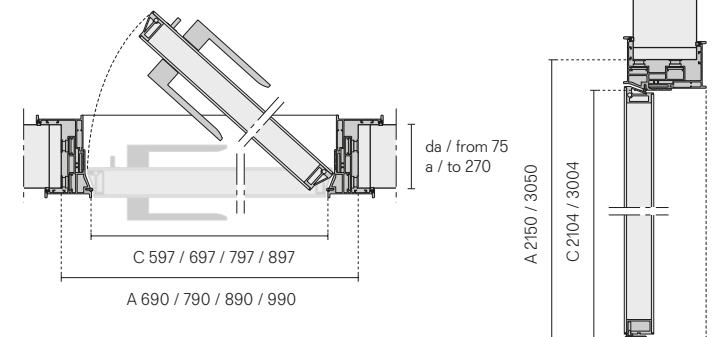

Sinistra / left

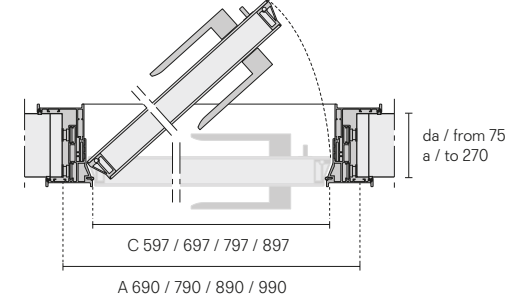

Porta scorrevole per controtelai a scomparsa  
Pocket door

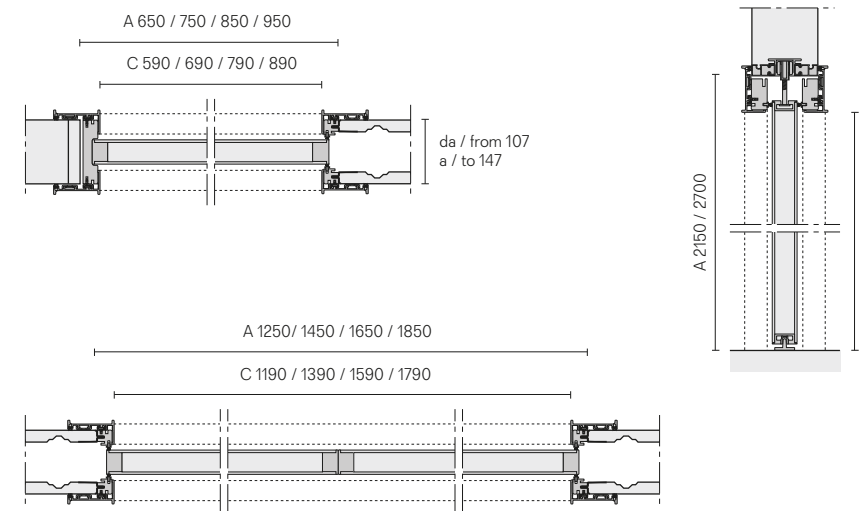

A. Luce netta falso telaio / Measure of the subframe  
C. Luce netta passaggio / Dimensions of the opening

Maniglie  
Handles

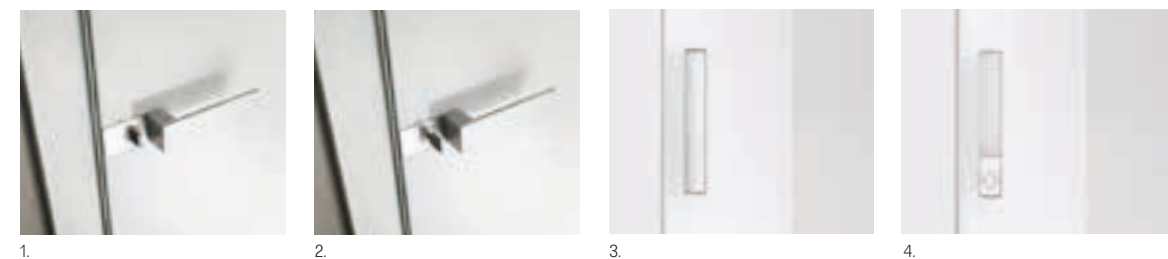

1.

2.

3.

4.

1. TR04 con nottolino.  
With revolving plug.
2. TR04C con chiave. / With key.
3. 2163
4. 2163N con nottolino.  
With revolving plug.  
2163C con chiave. / With key.



Design Giuseppe Bavuso

## Vela

Vela has a design with exceptionally innovative features. The door can open both ways: this is because it is installed in the centre of the jamb and the hinges are positioned on the top and bottom of the door. Vela with pivot opening comes in two versions: with a patented magnetic closing profile or with a magnetic lock. Both solutions take full advantage of a basic physical principle, deleting the need of mechanisms and always guaranteeing light and silent movements.

Un progetto dalle eccezionali caratteristiche innovative. Vela è apribile indifferentemente da entrambi i lati, soluzione consentita dalla centralità rispetto allo stipite e dai cardini posti sui lati inferiore e superiore della porta. Vela con apertura battente è disponibile in due versioni: con profilo di chiusura magnetico brevettato e con serratura magnetica. Entrambe sfruttano un principio fisico basilare, eliminando la necessità di meccanismi e garantendo movimenti sempre leggeri e silenziosi.

Ein Projekt mit außergewöhnlichen innovativen Funktionen. Vela kann auf beiden Seiten geöffnet werden, eine Lösung, die zentral für den Pfosten und die Scharniere an der unteren und oberen Seite der Tür sind. Vela ist mit klappbarer Öffnung in zwei Versionen erhältlich: mit patentiertem magnetischem Schließprofil und Magnetverschluss. Beide nutzen ein grundlegendes physikalisches Prinzip, das die Notwendigkeit von Mechanismen eliminiert und leichte und leise Bewegungen garantiert sind.

Un projet avec des caractéristiques innovantes exceptionnelles. Vela peut être ouvert des deux côtés, grâce à la position centrale du panneau et aux charnières sur les côtés inférieurs et supérieurs de la porte. Vela battante est disponible dans deux versions: avec le profil de fermeture magnétique breveté et avec la serrure magnétique. Tous deux exploitent un principe physique fondamental, éliminant le besoin de mécanismes et garantissant des mouvements toujours légers et silencieux.

Un proyecto con características innovadoras excepcionales. Vela se puede abrir en ambos lados, una solución permitida por la centralidad con respecto a la jamba y las bisagras en el lado inferior y superior de la puerta. Vela con apertura batiente está disponible en dos versiones: con perfil de cierre magnético patentado y cerradura magnética. Ambas utilizan un principio físico básico, eliminando la necesidad de mecanismos y asegurando movimientos que son siempre ligeros y silenciosos.



L'ambientazione valorizza la qualità estetica del progetto Vela. Lo stipite, incassato a parete, diventa invisibile: la porta viene percepita come un'unica superficie di vetro, perfettamente integrata nella parete.

The setting highlights the aesthetic quality of the Vela design. The jamb, which is recessed into the wall, becomes invisible: the door is seen as a single glass surface, perfectly integrated into the wall.

Das Ambiente betont die ästhetische Qualität des Projekts Vela. Der Pfosten, in der Wand eingebaut, wird unsichtbar: man fühlt die Tür als eine einzige Glas-Oberfläche, perfekt in der Wand integriert.

L'ambiance valorise la qualité esthétique du projet Vela. Le jambage, encastré dans le mur, devient invisible: la porte est perçue comme une seule surface de verre, parfaitement intégrée dans la paroi.

La ambientación revaloriza la calidad estética del proyecto Vela. La jamba, embutida en la pared, queda invisible: la puerta se percibe como una única superficie de cristal, perfectamente integrada en la pared.





Porta battente con profilo magnetico di chiusura  
Swing door with magnetic closing profile

Porta battente con serratura magnetica  
Swing door with magnetic lock



Porta scorrevole per controtelai / Pocket door for systems  
Scrigno® Essential, Eclisse® Syntesis® line



Ingombri tecnici  
Technical encumbrance

Porta battente standard  
Standard swing door

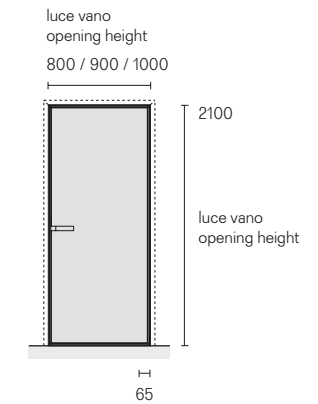

Porta battente su misura  
Customized swing door  
900 x 2600

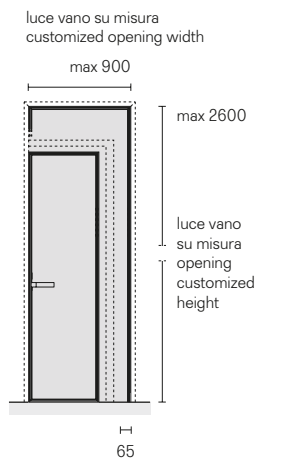

Porta battente su misura  
Customized swing door  
1200 x 2600

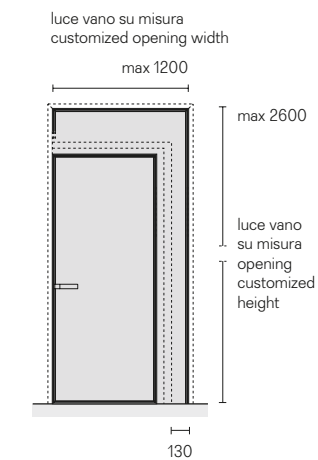

Porte scorrevole su misura  
Customized sliding door

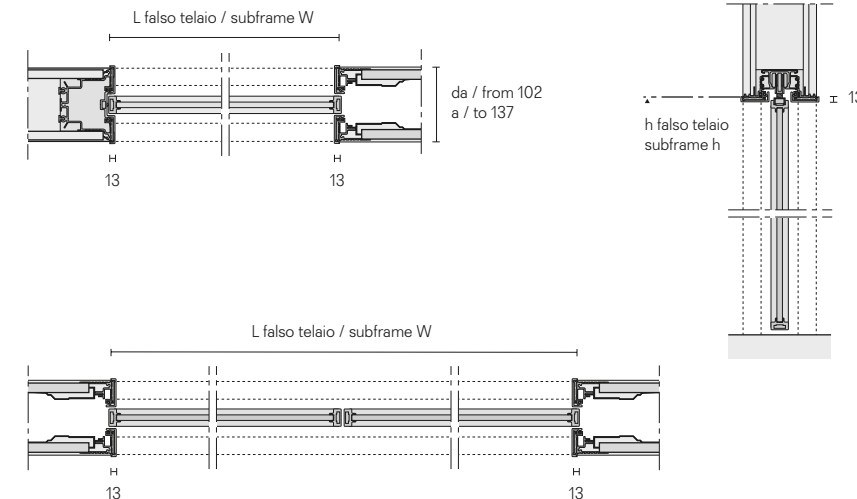
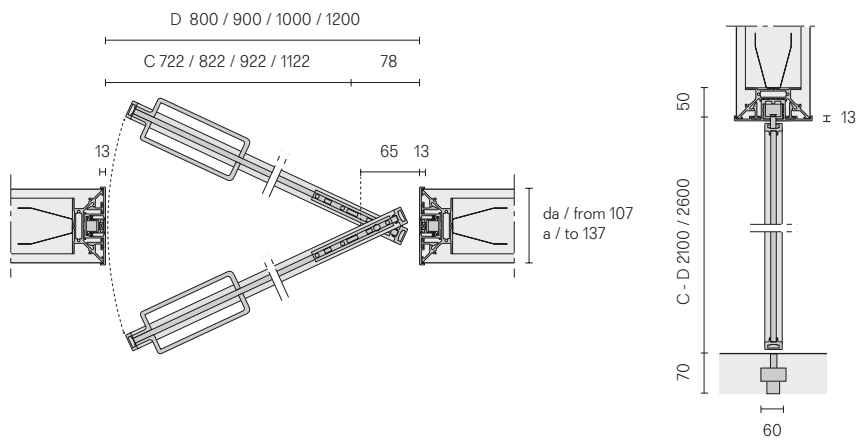
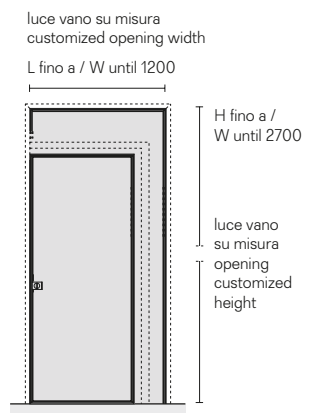

Descrizione tecnica  
Technical description

La porta Vela con sistema di chiusura magnetica a scomparsa è dotata di un profilo di battuta in gomma siliconica, che assicura silenziosità e affidabilità nel tempo. Le versioni battente e scorrevole presentano uno stipite telescopico in alluminio anodizzato o verniciato che permette di compensare lo spessore di eventuali rivestimenti, con un'escursione massima di 15 mm per lato.

Vela door with magnetic closing system has a perimetral joint in silicone rubber that ensures cushion and reliability. The versions swing and pocket doors have an anodized or lacquered aluminium telescopic jamb that can compensate for potential coating thickness, with a maximum of 15 mm per side.

Die Tuer Vela mit magnetischem Schloss in Mauertasche ist mit einer Gummidichtung aus Silikon vorgesehen. Die Dichtung versichert die Geräuschlosigkeit und die Zuverlässigkeit auf Dauer. Die Drehfl- bzw. Schiebetüren versionen zeigen einen teleskopischen Türpfosten in anodisiertem Aluminium oder lackiert, der erlaubt die Wandstärke eventueller Wandverkleidungen zu kompensieren, beiden Seiten bis zu maximum 15 mm.

La porte Vela avec un système de fermeture magnétique rétractable est disponible avec un profil de butée en caoutchouc de silicone, ce qui assure un silence et une fiabilité au fil du temps. La version battante et galandage ont un jambage télescopique en aluminium anodisé ou laqué, qui peut éventuellement compenser l'épaisseur des revêtements, sur les deux côtés jusqu'à 15 mm au maximum.

La puerta Vela con el sistema de cierre magnético embutido tiene un perfil de golpe de goma de silicona, que garantiza silencio y fiabilidad en el tiempo. La versión batiente y corredera tienen una jamba telescópica en aluminio anodizado o pintado, que permite compensar el espesor de eventuales revestimientos, con una excursión máxima de 15 mm por cada lado.

Maniglie  
Handles



- 1304
- TR01 con nottolino. With revolving plug. TR01C con chiave. / With key.
- 3205
- 2093 con serratura. 2093 lock and counter lock.



Design Giuseppe Bavuso

## Aura

A door thought as an essential surface, with a minimum thickness jamb. Equipped with a bidirectional opening, Aura is available with a patented magnetic closing profile or with a magnetic lock. Both solutions take advantage of a basic physical principle, deleting the need of mechanisms and always guaranteeing light and silent movements.

Una porta concepita come una superficie essenziale, con uno stipite di minimo spessore. Dotata di un sistema di apertura bidirezionale, Aura con apertura battente è disponibile in due versioni: con profilo di chiusura magnetico brevettato e con serratura magnetica. Entrambe le versioni sfruttano un principio fisico basilare, eliminando la necessità di meccanismi e garantendo movimenti sempre leggeri e silenziosi.

Eine Tür, deren wesentliche Oberfläche mit einem subtilen Pfosten konzipiert ist. Aura ist mit klappbarer Öffnung in zwei Versionen erhältlich: mit patentiertem magnetischem Schließprofil und Magnetverschluss. Beide Versionen nutzen ein grundlegendes physikalisches Prinzip, das die Notwendigkeit von Mechanismen eliminiert und leichte und leise Bewegungen garantiert.

Une porte conçue comme une surface essentielle, avec un jambage d'épaisseur minimum. Équipé d'un système d'ouverture bidirectionnel, Aura battante est disponible dans deux versions: avec le profil de fermeture magnétique breveté et avec la serrure magnétique. Les deux versions exploitent un principe physique de base, éliminant le besoin de mécanismes et garantissant des mouvements toujours légers et silencieux.

Una puerta concebida como una superficie esencial, con una jamba de espesor mínimo. Dotada de un sistema de apertura bidireccional, Aura con apertura batiente está disponible en dos versiones: con perfil de cierre magnético patentado y cerradura magnética. Ambas versiones utilizan un principio físico básico, eliminando la necesidad de mecanismos y garantizando movimientos que son siempre livianos y silenciosos.





Porta battente con profilo magnetico di chiusura  
Swing door with magnetic closing profile



Porta battente con serratura magnetica  
Swing door with magnetic lock



Porta scorrevole per controtelai / Pocket door for systems  
Scrigno® Essential, Eclipse® Syntesis® line



Ingombri tecnici  
Technical encumbrances

Porta battente standard  
Standard swing door

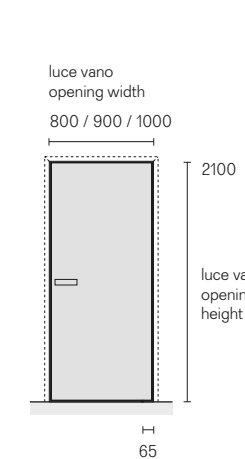

Porta battente su misura  
Customized swing door  
900 x 2600

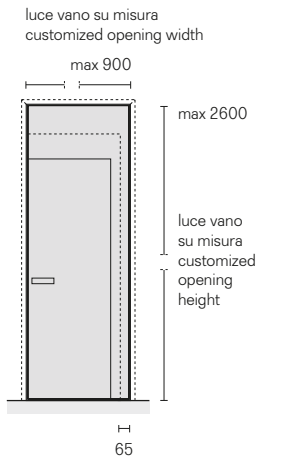

Porta battente su misura  
Customized swing door  
1200 x 2600

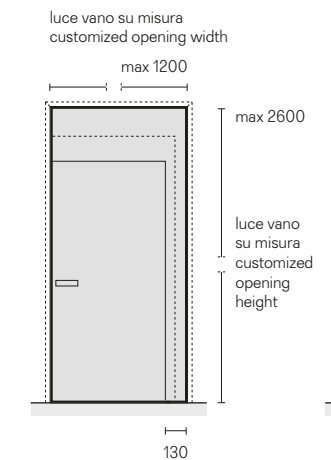

Porta scorrevole su misura  
Customized sliding door

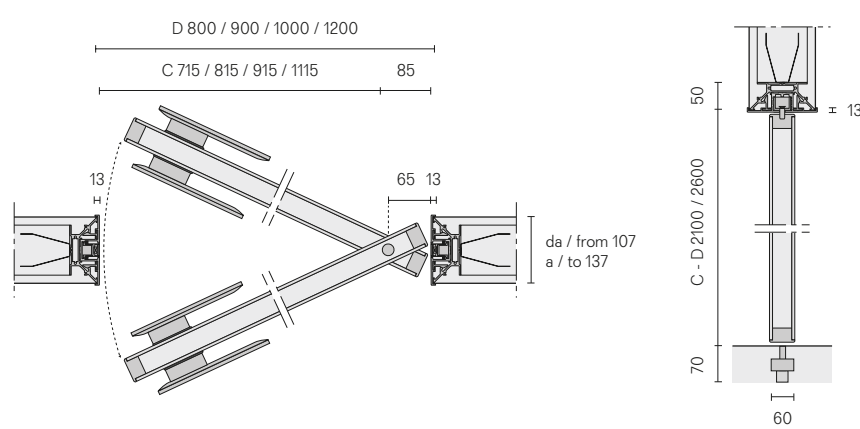
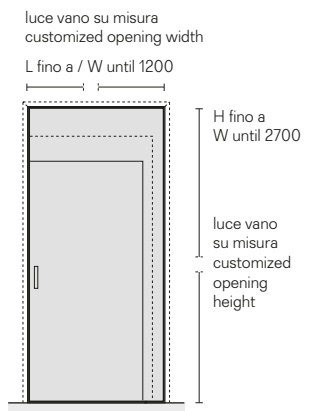

C. Luce passaggio / Dimensions of the passage  
D. Luce vano / Dimensions of the opening

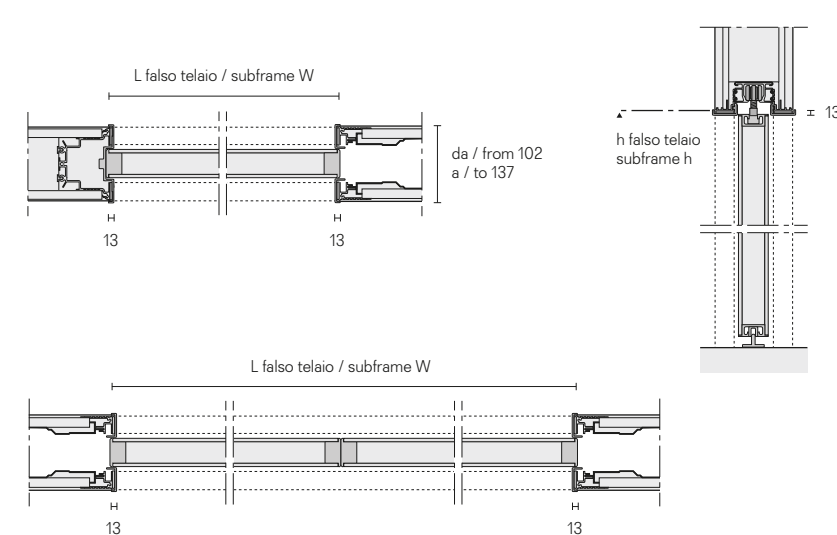

Descrizione tecnica  
Technical description

La porta Aura con sistema di chiusura magnetica a scomparsa è dotata di un profilo di battuta in gomma siliconica, che assicura silenziosità e affidabilità nel tempo. Le versioni battente e scorrevole presentano uno stipite telescopico in alluminio anodizzato o verniciato che permette di compensare lo spessore di eventuali rivestimenti, con un'escursione massima di 15 mm per lato.

Aura door with magnetic closing system has a perimetral joint in silicone rubber that ensures cushion and reliability. The swing and pocket doors have an anodized or lacquered aluminium telescopic jamb that can compensate for potential coating thickness, with a maximum of 15 mm per side.

Die Tuer Aura mit magnetischem Schloss in Mauertasche ist mit einer Gummidichtung aus Silikon vorgesehen. Die Dichtung versichert die Geraeuschosigkeit und die Zuverlaessigkeit auf Dauer. Die Drehfl- bzw. Schiebetuere versionen zeigen einen teleskopischen Turpfosten in anodisiertem Aluminium oder lackiert, der erlaubt die Wandstärke eventueller Wandverkleidungen zu kompensieren, beiden Seiten bis zu maximum 15 mm.

La porte Aura avec un système de fermeture magnétique rétractable est disponible avec un profil de butée en caoutchouc de silicone, ce qui assure un silence et une fiabilité au fil du temps. La version battante et galandage ont un jambage télescopique en aluminium anodisé ou laqué, qui peut éventuellement compenser l'épaisseur des revêtements, sur les deux côtés jusqu'à 15 mm au maximum.

La puerta Aura con el sistema de cierre magnético embudido tiene un perfil de golpe de goma de silicona, que garantiza silencio y fiabilidad en el tiempo. La versión batiente y corredera tienen una jamba telescópica en aluminio anodizado o pintado, que permite compensar el espesor de eventuales revestimientos, con una excursión máxima de 15 mm por cada lado.

Maniglie  
Handles



1. TR02 con nottolino. / With revolving plug.
2. TR02C con chiave. / With key.
3. 2124
4. 2163
5. TR03 con nottolino. / With revolving plug.
6. TR03C con chiave. / With key.
7. 2097 con nottolino. / With revolving plug.
8. 2163N con nottolino. / With revolving plug.



Design Giuseppe Bavuso

## Even

Available in swing or pocket version, Even represents the stylistic completion of the sliding doors Stripe, characterized by the horizontal crosspieces on both sides of the door, making it perfectly double-sided. The essential concept is highlighted by the recessed handle, achieved with the particular design of both opening versions and with the perfect finishing homogeneity.

Disponibile nelle versioni battente e scorrevole, Even rappresenta il naturale completamento delle porte scorrevoli Stripe, caratterizzate dal particolare disegno dei traversi orizzontali che completano su entrambi i lati il pannello in vetro stratificato. L'immagine essenziale è sottolineata dalla perfetta integrazione della maniglia, risultato ottenuto dal particolare design di entrambe le versioni di apertura e dalla perfetta uniformità della finitura.

Even ist in den Varianten der Dreh- und Schiebetür erhältlich und ist eine Ergänzung zu den Schiebetüren Stripe, die sich durch die besondere Konstruktion der Querbalken auszeichnen, die die Verbundglasscheibe auf beiden Seiten vervollständigen. Das essenzielle Image wird durch die perfekte Integration des Griffs hervorgehoben. Letzteres wird durch das besondere Design der beiden Öffnungsvarianten und die perfekte Gleichmäßigkeit der Oberfläche erzielt.

Disponibile dans les versions battante et galandage, Even représente l'achèvement naturel des panneaux coulissants Stripe, caractérisés par la conception particulière des traverses horizontales qui complètent le panneau de verre feuilleté des deux côtés. L'image essentielle est soulignée par l'intégration parfaite de la poignée, un résultat obtenu par le design particulier des deux versions d'ouverture et la parfaite uniformité de la finition.

Disponibile en version batiente y corredera, Even representa el complemento natural de los paneles correderos Stripe, caracterizados por el diseño particular de travesaños horizontales que completan el panel de vidrio estratificado en ambos lados. La imagen esencial queda subrayada por la perfecta integración del tirador, resultado obtenido por el diseño particular de ambas versiones de apertura y la perfecta uniformidad del acabado.



Porta battente  
Swing door

Porta battente slim  
Slim swing door

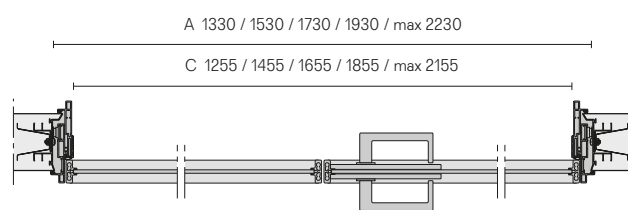
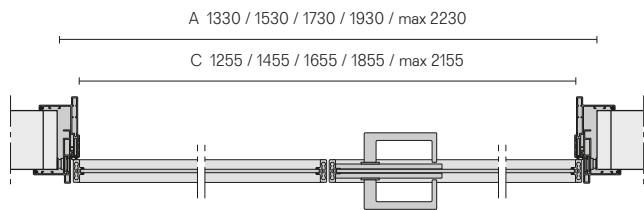
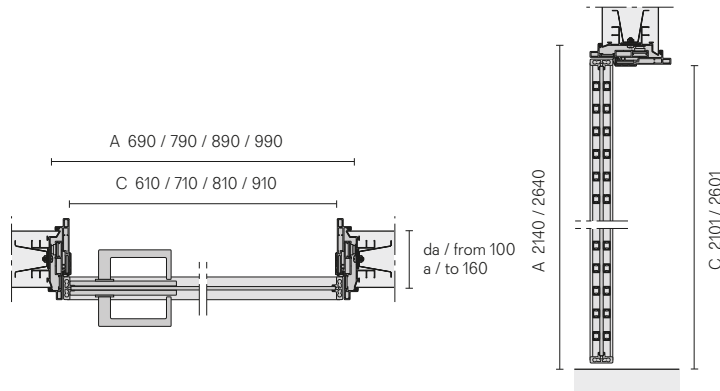
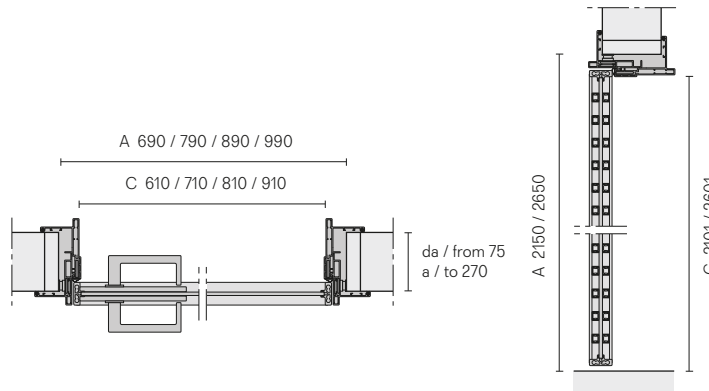

A. Luce netta falso telaio / Measure of the subframe  
C. Luce netta passaggio / Dimensions of the opening

Descrizione tecnica  
Technical description

Even, in versione battente e scorrevole, prosegue nell'esplorazione dell'estetica dei traversi orizzontali introdotti con la porta Stripe. Entrambe le versioni sono dotate di uno stipite telescopico in alluminio che permette di compensare lo spessore di eventuali rivestimenti e di ridurre i tempi di montaggio.

Even, in swing or pocket version, carries on the exploration of the crosspieces' aesthetics introduced by the Stripe model. Both versions are equipped with an aluminium telescopic jamb which allows to balance any claddings' thickness and to reduce the assembly time.

Even, führt in der Dreh- und Schiebetürversion die Erforschung der Ästhetik horizontaler Querbalken fort, die die Tür Stripe eingeführt hatte. Beide Varianten sind mit einem teleskopischen Türpfosten aus Aluminium ausgestattet, der die eventuelle Beschichtungsdicke zu reduzieren weiß und dadurch die Montagezeit kompensiert.

Even, en version porte battante et à galandage, continue l'exploration de l'esthétique des traverses horizontales introduite avec la porte Stripe. Les deux versions ont un jambage télescopique en aluminium qui permet de supprimer les différences d'épaisseur de parois et de réduire le temps de montage.

Even, en versión batiente y corredera, prosigue en la exploración de la estética de los travesaños horizontales introducidos con el panel Stripe. Ambas versiones están dotadas de una jamba telescópica en aluminio que permite compensar el grosor de eventuales revestimientos y de reducir los tiempos de montaje.

Porta scorrevole per controlelai a scomparsa  
Pocket door



Porta scorrevole slim per controlelai  
Slim pocket door for systems  
Scrigno® Essential, Eclisse® Syntesis® line

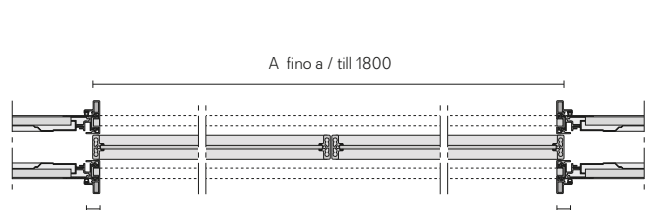
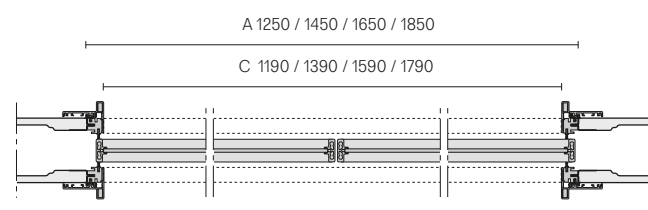
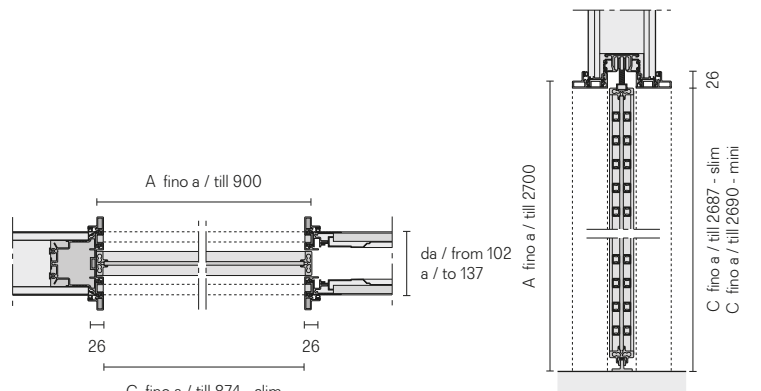
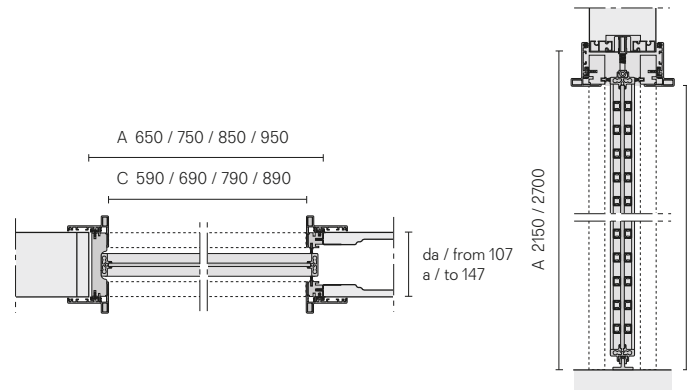

Maniglie  
Handles



1. TR05 con nottolino. With revolving plug. TR05C con chiave. / With key.  
2. 2094 con serratura. 2094 lock and striker plate.



Design Giuseppe Bavuso

## Spin

Door with monolithic laminated glass, available in both swing and pocket version, both solutions come with adjustable telescopic or slim jamb. The swing version is equipped with concealed reversible hinges that allow to reverse the opening direction, thus reducing the assembly time. The magnetic lock system is an exclusive Rimadesio patent.

Porta con vetro accoppiato monolastra, disponibile nelle versioni battente e scorrevole, entrambe con soluzione con controtelaio regolabile telescopico o slim. La versione battente è dotata di cerniere reversibili a scomparsa che permettono di invertire il senso di apertura con una conseguente riduzione dei tempi di montaggio. Il sistema di chiusura magnetico della serratura è un brevetto esclusivo Rimadesio.

Diese Tür aus gekuppeltem Flachglas sind in der Dreh- und Schiebeversion erhältlich. Beide Versionen gibt es mit verstellbarem teleskopischem oder schlankem Gegenrahmen. Die markante Version ist mit reversiblen Scharnieren ausgestattet, die das Umkehren der Öffnungsrichtung ermöglichen und somit die Montagezeit reduzieren. Das Magnetverschluss-System ist ein exklusives Rimadesio-Patent.

Porte avec une seule verre couplé, disponible dans les versions battante et glissement, et dans les deux cas avec jambage télescopique réglable ou slim. La version battante est équipée de charnières réversibles, qui permettent d'inverser le sens d'ouverture avec une réduction conséquente du temps de montage. Le système de verrouillage magnétique est un brevet exclusif de Rimadesio.

Puerta con vidrio acoplado monolítico, disponible en versiones batiente y corredera, ambas con solución con contramarco telescópico regulable o slim. La versión batiente está dotada de bisagras reversibles que permiten invertir cambiar el sentido de apertura con la consiguiente reducción del tiempo de montaje. El sistema de cierre magnético de la cerradura es una patente exclusiva de Rimadesio.



Porta battente  
Swing door

Porta battente slim  
Slim swing door

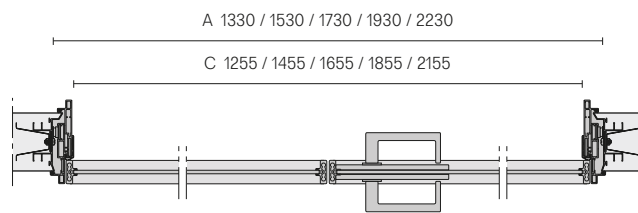
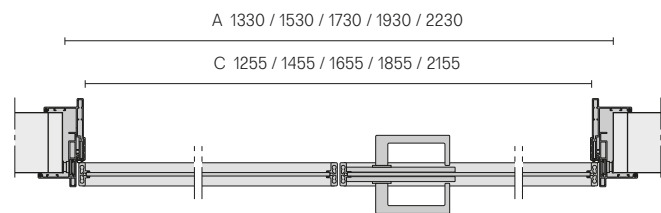
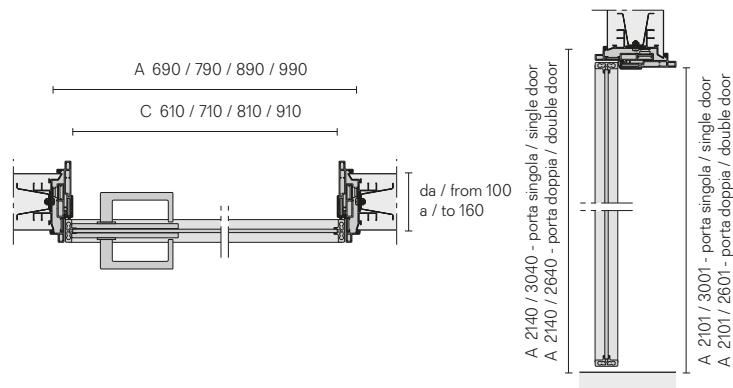
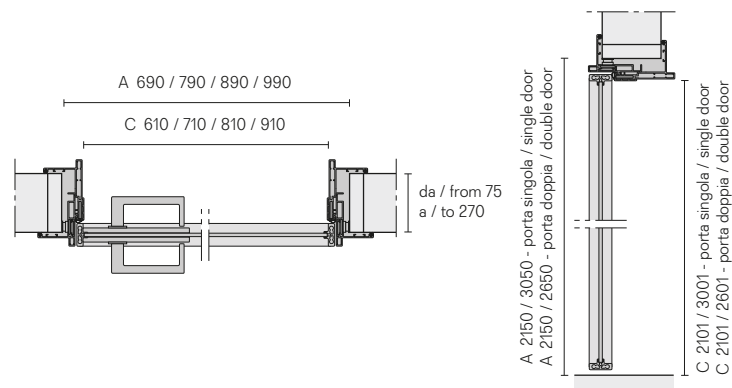

A. Luce netta falso telaio / Measure of the subframe  
C. Luce netta passaggio / Dimensions of the opening

Descrizione tecnica  
Technical description

Il progetto è dotato di cerniere reversibili a scomparsa che permettono di invertire il senso di apertura e garantiscono tempi di montaggio ridotti. L'esclusivo stipite telescopico in alluminio, disponibile sulla versione battente e scorrevole, anche nella versione slim, consente di annullare le differenze di spessore fra le pareti. La serratura magnetica è un progetto esclusivo che riflette un nuovo approccio verso i meccanismi legati all'apertura e alla chiusura.

The product is equipped with concealed reversible hinges that allow to reverse the opening direction and guarantee very short assembly times. The exclusive telescopic aluminium jamb allows to hide the differences in wall thickness. It is available in the swing and pocket version, in standard or slim version. The Rimadesio patented magnetic lock is an exclusive design that reflects a new approach to the opening and closing mechanisms.

Das Design ist mit reversiblen Scharnieren ausgestattet, die die Umkehrung der Öffnungsrichtung erlauben und dadurch sehr kurze Montagezeiten ermöglichen. Der exklusive Teleskopposten aus Aluminium, der in der Dreh- und Schiebetürversion erhältlich ist, ermöglicht den Ausgleich eventueller Unterschiede in der Dicke zwischen den Wänden. Der patentierte Magnetmechanismus ist ein exklusives Design, das einen neuen Gestaltungsansatz gegenüber Schließ- und Öffnungsmechanismen widerspiegelt.

Le projet est doté de charnières réversibles escamotables qui permettent d'inverser le sens de l'ouverture et garantissent des temps de montage très brefs. Le jambage télescopique exclusif en aluminium, disponible en version battant et galandage et dans la version slim, permet de supprimer les différences d'épaisseur de paroi. La serrure magnétique est un projet exclusif de Rimadesio, qui reflète une nouvelle approche pour les mécanismes liés à l'ouverture et à la fermeture

El proyecto está dotado de bisagras reversibles ocultas que permiten invertir el sentido de apertura y garantizan tiempos de montaje muy cortos. La exclusiva jamba telescópica en aluminio disponible en la versión batiente y corredera, también en la versión slim, permite anular las diferencias de grosor entre las paredes. La cerradura magnética es un proyecto exclusivo que refleja un nuevo enfoque hacia los mecanismos relacionados con la apertura y el cierre.

Porta scorrevole per controlelai a scomparsa  
Pocket door



Porta scorrevole slim per controlelai  
Slim pocket door for systems  
Scigno® Essential, Eclipse® Syntesis® line

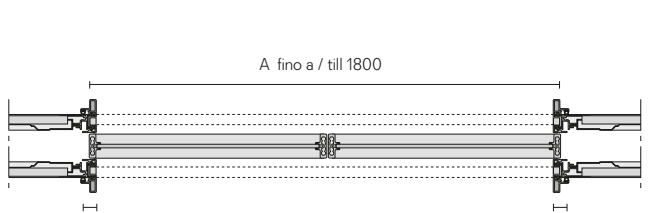
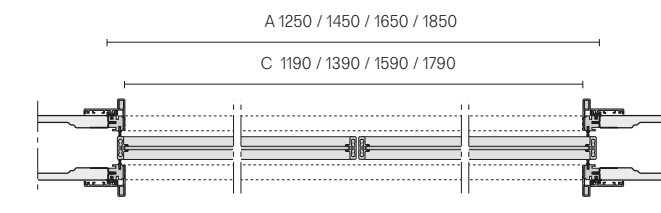
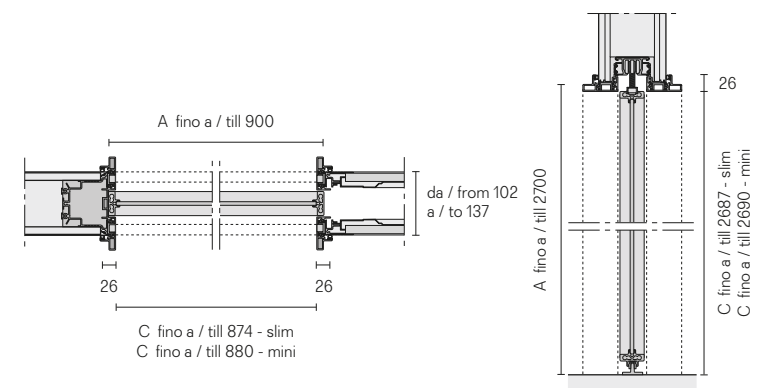
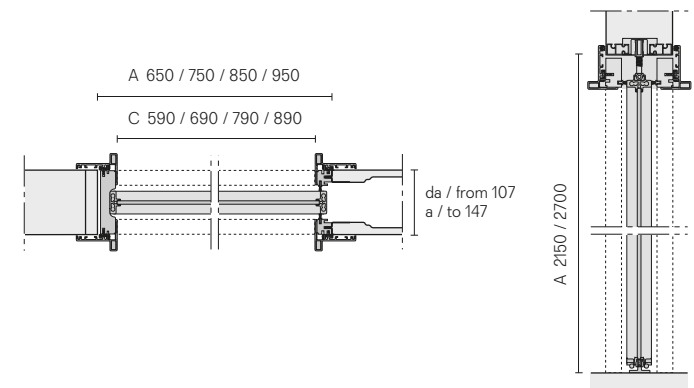

Maniglie  
Handles



1. 2. 1. TR01 con nottolino. With revolving plug. TR01C con chiave. / With key. 2. 2093 con serratura e riscontro senza viti a vista. 2093 lock and striker plate without any exposed screws.



Design Giuseppe Bavuso

Link+

Rimadesio's exclusive chromatic range as well as the custom made dimensions, allow a new concept of furniture design, where each architectural element is fully customized, providing high stylistic coherence.

L'esclusività della gamma cromatica Rimadesio al servizio di progetti d'arredo di nuova concezione, in cui ogni elemento architettonico può essere personalizzato al massimo grado, all'insegna della massima coerenza stilistica.

Die Exklusivität der Rimadesio Farbskala steht im Dienste neuer Einrichtungskonzeptionen, wo jedes architektonische Element im Zeichen maximaler stilistischer Konsequenz in höchstem Grade individuell gestaltet werden kann.

L'exclusivité de la gamme chromatique Rimadesio au service de projets d'ameublement de nouvelle conception, dans lesquels chaque élément architectural peut être personnalisé au maximum, à l'instar de la plus grande cohérence stylistique.

La exclusiva gama cromática Rimadesio al servicio de proyectos de decoración de nueva concepción, en los que cada elemento arquitectónico puede ser personalizado al máximo, caracterizada por la más absoluta coherencia estilística.



Un sottile profilo in alluminio disegna il contorno di una pura superficie che vive di riflessi e della forza dei colori. Link+ è dotata della serratura con sistema di chiusura magnetico, un innovativo brevetto Rimadesio che assicura silenziosità e affidabilità nel tempo. Le maniglie sono previste sia per la versione battente che per quella scorrevole: caratteristica estetica principale è la totale integrazione fra blocco maniglia e pannello in vetro, che formano un'unica superficie ininterrotta.

A thin aluminum profile defines the perimeter of a pure surface that lives on reflections and the power of colors. Link+ is equipped with the lock system with the magnetic latch, an innovative system patented by Rimadesio, allowing silence and reliability. Handles are available both in the swing and pocket version: a main aesthetical characteristic is the total integration between the handle block and the glass panel, that create a unique and continuous surface.

Das hauchdünne Aluminiumprofil zeichnet den Umriss einer reinen Oberfläche, die von Reflexionen und der Kraft der Farben lebt. Link+ ist mit einem Magnetverschluss ausgestattet, einem innovativen Rimadesio-Patent, das im Laufe der Zeit für Ruhe und Zuverlässigkeit sorgt. Die Griffe sind sowohl für die Dreh- als auch für die Schiebeversion erhältlich: Das ästhetische Hauptmerkmal ist die vollständige Integration zwischen dem Griffblock und der Glasplatte, die eine einzige ununterbrochene Oberfläche bilden.

Un mince profil en aluminium dessine le contour d'une surface pure qui vit sur les reflets et la puissance des couleurs. Link+ est équipé d'une serrure avec système de verrouillage magnétique, un brevet innovant Rimadesio, qui garantit silence et fiabilité dans le temps. Les poignées sont fournies pour la version battante et glissante: la principale caractéristique esthétique est l'intégration totale entre le bloc de la poignée et le panneau de verre, qui forment une seule surface ininterrompue.

Un perfil fino de aluminio dibuja el contorno de una superficie pura que vive de los reflejos y el poder de los colores. Link+ está dotada de un sistema de cierre magnético, una patente innovadora Rimadesio que garantiza silencio y fiabilidad a lo largo del tiempo. Las manillas están disponibles tanto para la versión con batiente como la corredera: la característica estética principal es la integración total entre la cerradura y el panel de vidrio, que forman una única superficie ininterrumpida.



Porta battente  
Swing door

Porta battente slim  
Slim swing door

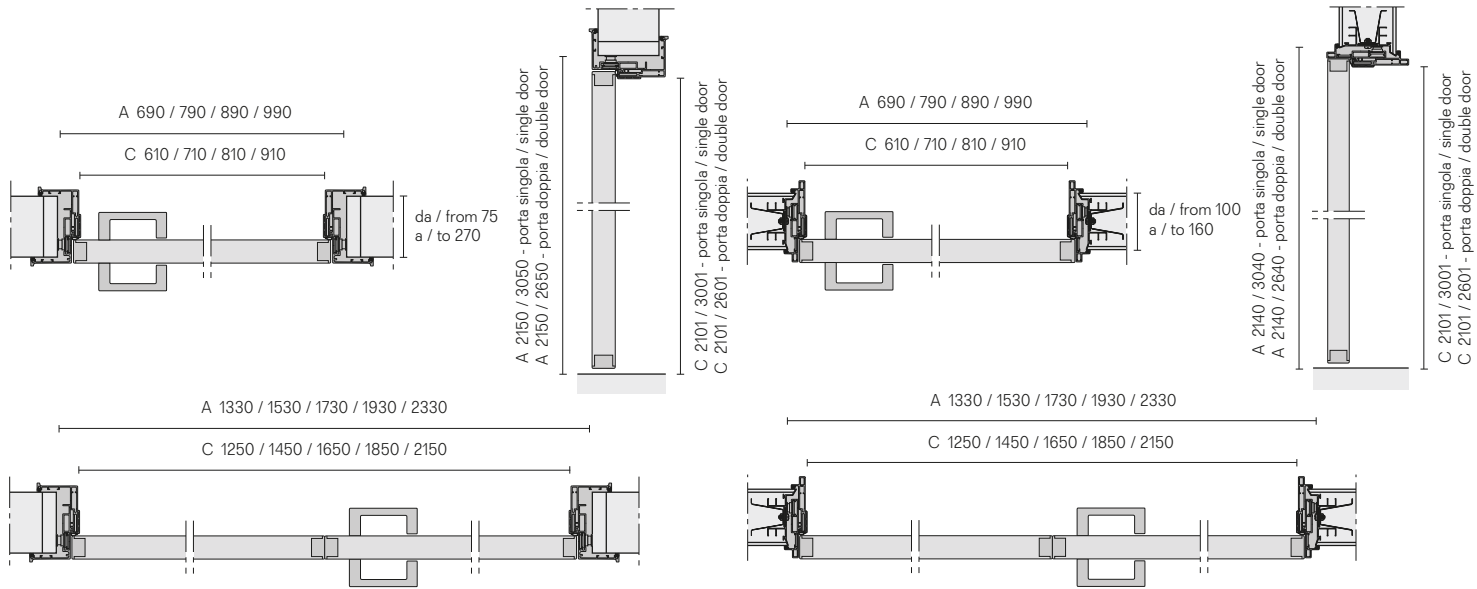

A. Luce netta falso telaio / Measure of the subframe  
C. Luce netta passaggio / Dimensions of the opening

Descrizione tecnica  
Technical description

Un progetto che esplora tutte le possibilità della porta in vetro laccato, caratterizzata dalle tinte esclusive della collezione Rimadesio. Caratteristica estetica principale è la totale integrazione fra blocco maniglia e pannello in vetro, che formano un'unica superficie ininterrotta. L'esclusivo stipite telescopico in alluminio, disponibile per le versioni battente e scorrevole, consente di annullare le differenze di spessore tra le pareti. Link+ è disponibile anche nella versione slim, caratterizzata dal copristipite di minimo spessore.

A design that explores all the possibilities offered by a lacquered glass door, characterised by the exclusive shades of the Rimadesio collection. The principal aesthetic characteristic is the total integration between the handle block and the glass panel that form a single uninterrupted surface. The exclusive telescopic jamb, available in the swing and pocket versions, cancels the differences between the wall thicknesses. Link+ is also available in a slim version, characterised by ultra thin jamb.

Ein Design, das alle Möglichkeiten der lackierten Glastür ausschöpft, das die exklusive Rimadesio Farbtongkollektion kennzeichnet. Der charakteristische Fokus der Ästhetik zielt auf die Gesamtintegration von Griffblock und Glasplatten ab, die eine einheitlich ungebrochene Fläche bilden. Die exklusiven Teleskoppfosten aus Aluminium in der Dreh- und Schiebetürversion, werden verwendet, um die Unterschiede in der Dicke zwischen den Wänden auszugleichen. Link+ ist auch in einer schlanken Version mit extrem dünnen Pfosten erhältlich.

Un projet qui explore toutes les possibilités de porte en verre laqué, caractérisé par les teintes exclusives de la collection Rimadesio. La caractéristique esthétique principale est l'intégration totale entre le bloc poignée et le panneau en verre, qui forment une seule surface continue. Le jambage télescopique exclusif en aluminium, disponible en version battant et galandage, permet de supprimer les différences d'épaisseur de paroi. Link+ est aussi disponible dans la version slim, caractérisée par un jambage d'épaisseur minimum.

Un proyecto que explora todas las posibilidades de la puerta en cristal lacado, caracterizada por los acabados de la colección Rimadesio. Característica estética principal es la total integración entre conjunto manilla y panel en cristal que forman una única superficie ininterrumpida. La exclusiva jamba telescópica en aluminio, disponible para las versiones batiente y corredera, permite anular las diferencias de grosor entre las paredes. Link+ está disponible también en la versión Slim, caracterizada por la cubrejamba de grosor mínimo.

Porta scorrevole per controlelai a scomparsa  
Pocket door



Porta scorrevole slim per controlelai  
Slim pocket door for systems  
Scrigno® Essential, Eclisse® Syntesis® line

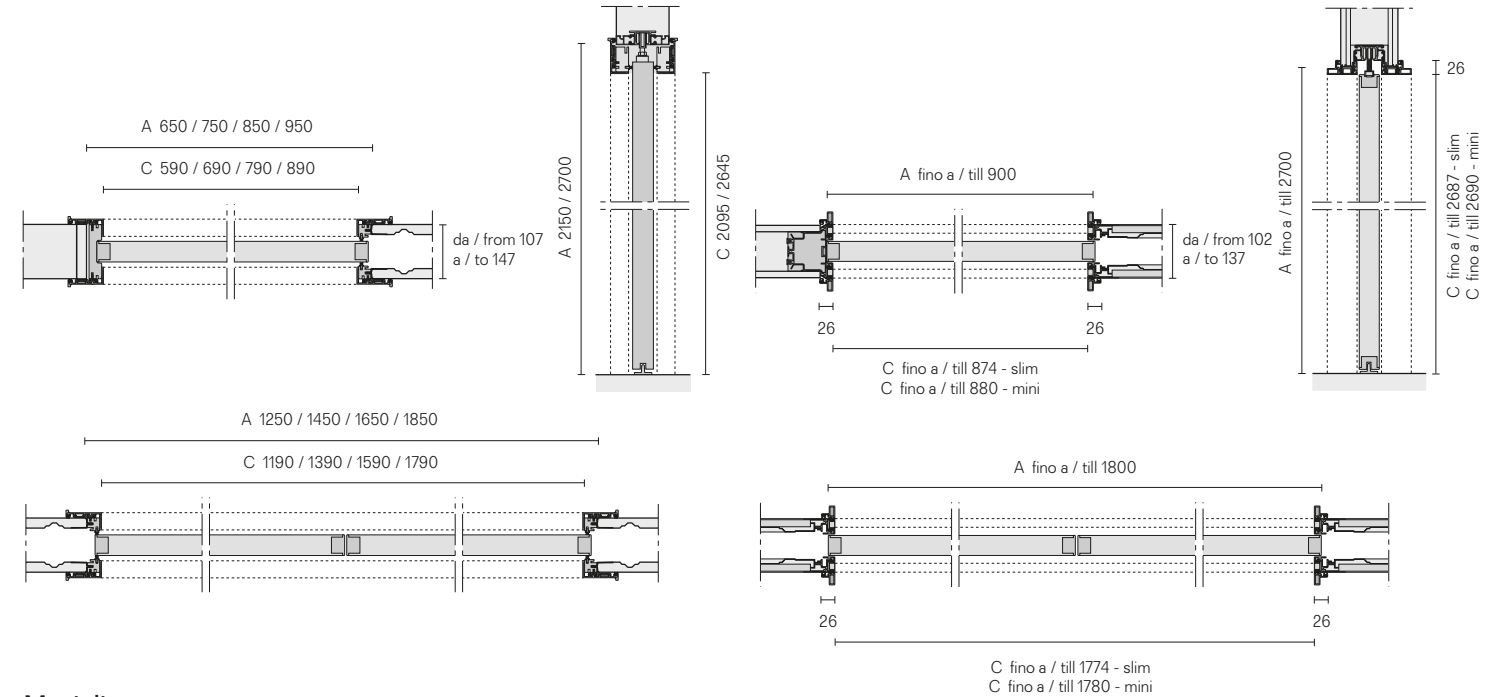

Maniglie  
Handles



TR03 con nottolino.  
With revolving plug.  
TR03C con chiave. / With key.



TR02 con nottolino.  
With revolving plug.  
TR02C con chiave. / With key.



2097 con nottolino.  
With revolving plug.



2163



2163N con nottolino.  
With revolving plug.  
2163C con chiave. / With key.

# Storage system

231 Cover, 255 Cover freestanding



Design Giuseppe Bavuso

## Cover

Closing system equipped with single-face hinged doors in glass, gres, fabric and synthetic leather. The core of the Cover project is the uprights, fixed to the ceiling and to the floor, which gather the concealed hinges of the door and the exclusive integrated internal led lighting system. Shelves and drawers are fixed directly to the uprights without visible screws, which allows a free and easily adjustable arrangement.

Sistema di chiusura attrezzato con ante battenti monofronte in vetro, grès, tessuto e similpelle. Fulcro del progetto Cover sono i montanti, fissati a soffitto e a pavimento, che raccolgono i cardini invisibili delle ante e l'esclusivo sistema integrato di illuminazione interna a led. Mensole e cassettiere vengono fissate ai montanti con un sistema ad incastro, senza viti a vista, che consente una disposizione libera e modificabile nel tempo con estrema facilità.

System mit Drehtüren aus Glas, Grès, Stoff und Kunstleder. Der Kern des Projekts Cover sind die Pfosten, die an der Decke und am Boden befestigt sind und die unsichtbaren Scharniere der Türen und das exklusive integrierte System der internen Led-Beleuchtung sammeln. Regale und Schubladen sind an den Pfosten mit einem Verriegelungssystem ohne sichtbare Schrauben befestigt, was eine freie und modifizierbare Anordnung mit extremer Leichtigkeit ermöglicht.

Système de fermeture équipé de portes battantes, en verre, grès, tissu et similcuir. Le cœur du projet Cover sont les montants, fixés au plafond et au sol, qui intègrent les charnières invisibles des portes et le système exclusif d'éclairage led à l'intérieur. Les étagères et les tiroirs sont fixés aux montants avec un système à encastrerment, sans vis visibles, avec libre disposition, qui peut être facilement modifiée ensuite.

Sistema de cierre equipado con puertas batientes de un solo lado en vidrio, grès, tejido y similcuero. El núcleo del proyecto Cover son los montantes, fijados al techo y al suelo, que recogen las bisagras invisibles de las puertas y el exclusivo sistema integrado de iluminación led interna. Los estantes y los cajones se fijan a los montantes con un sistema de enganche, sin tornillos visibles, que permite una disposición libre y modificable en el tiempo con extrema facilidad.

Struttura e maniglia *Structure and handle*: 83 piombo  
 Ante e fianchi *Doors and sides*: 00 trasparente  
 Mensole *Shelves*: 63 grigio trasparente  
 Cassettiere sospese e porta bottiglie *Suspended drawers unit and bottle holder*: 25 melaminico larice carbone  
 Top e interni cassettiere *Top and internal drawers*: 154 similpelle argilla

Nella foto *In this photo*  
 Porta scorrevole  
 Sliding door: Graphis plus











Le ante Cover sono realizzate in vetro singolo temperato di spessore 4 mm, disponibili in tutti i vetri temperati di sicurezza: trasparenti, riflettenti, acidati, specchio e laccati opachi, lucidi e reflex nei 74 colori Ecoloursystem, in alternativa la versione in gres, disponibile in tre varianti di colore crema, moka e pietra, tessuto e similpelle.

La maniglia in metallo pressofuso, integrata nell'anta, è uno degli elementi di caratterizzazione estetica del progetto Cover. Il sistema prevede anche mensole in vetro con ring in alluminio, che offrono l'ulteriore possibilità di top rivestito similpelle.

The Cover doors are made of 4 mm thick single tempered glass, available in all safety tempered glass: transparent, reflective, etched, mirror and mat, glossy and reflex lacquered in the 74 Ecoloursystem colors, and as second option in gres, available in three colors crema, moka and piedra, fabric and synthetic leather.

The dye casting metal handle, integrated into the door, is one of the main aesthetic element of the Cover project. The system is also available with glass shelves with aluminium ring, providing an additional possibility to be covered with synthetic leather.

Die Türen sind aus 4 mm dickem gehärteten Glas, erhältlich in allen Sicherheitsglasarten: transparent, reflektierend, geätzt, Spiegel- und mat, glänzend und Reflex lackiert in den 74 Ecoloursystem Farben, alternativ ist die Version in Grès erhältlich in drei Varianten Creme, Moka und Piedra, Stoff und Kunstleder.

Der Druckguss-Griff der in die Tür integriert ist, ist eines der ästhetischen Charaktereigenschaften des Programms Cover. Das System sieht auch Glasböden mit Alu-Umrandung vor, die mit Kunstleders.

Les portes Cover sont en verre trempé simple de 4 mm d'épaisseur, disponible dans tous les verres trempés de sécurité: transparent, réfléchissant, acidé, miroir et laqué mat, brillant et reflex dans les 74 couleurs Ecoloursystem, ou en version céramique, disponible en trois couleurs Crema, Moka et Piedra, tissu et similicuir.

La poignée en métal moulé, intégrée dans la porte, est un élément de caractérisation esthétique du projet Cover. Le système comprend également des étagères en verre avec structure en aluminium, qui sur demande peuvent être recouverts par un plateau en similicuir.

Las puertas Cover están hechas de solo cristal templado de 4 mm de grosor, disponible en todos los cristales templados de seguridad: transparentes, reflectantes, acidados, espejo y lacados mate, brillante y reflex en los 74 colores Ecoloursystem, en alternativa la versión en gres, disponible en tres colores Crema, Moka y Piedra, tejido y simil cuero. La manilla en metal inyectado, integrada en la puerta, es una de los elementos de caracterización estética del proyecto Cover. El sistema prevé también estantes en cristal con aro en aluminio, que ofrecen la posibilidad del top revestido en simil cuero.







Cover è un sistema di ante battenti monofronte che possono essere utilizzate per chiudere gli ambienti dedicati alle cabine armadio o, in alternativa, per trasformare le nicchie in veri e propri armadi a muro. In questa pagina e nelle successive, una panoramica virtuale intorno ad una composizione Cover permette di descriverne al meglio l'assoluta novità concettuale. La struttura portante, fissata a soffitto e a pavimento, è il fulcro del sistema e riunisce i cardini invisibili delle ante, i montanti di fissaggio delle mensole con integrato l'esclusivo sistema di illuminazione interna a led.

Cover is a system of hinged doors, which can be used to close spaces dedicated to walk-in wardrobes or also to transform niches in real wall wardrobes. On this and on the following pages, a virtual overview around a Cover composition to best describe the absolute new concept. The supporting structure, fixed to the ceiling and the floor, includes the invisible door hinges and the fixing uprights for the shelves with an internal led lighting system.

Cover ist ein Flügeltürensysteem nur auf einer Seite lackiert, um die Schrankräume zu schließen oder, alternativ, die Nischen in echte Schränke zu verändern. Auf dieser und den folgenden Seiten: einer Überblick über die neue Konzept von Cover. Die Tragstruktur, an Decke und an Boden fixiert, ist der Drehpunkt des Systems und verbundet den unsichtbaren Scharnieren den Türen, die Pfosten für die Fixierung den Regalen mit den integrierter einzigartige innere Led Beleuchtung System.

Cover est un système de portes battantes unifaces qui peuvent être utilisées pour fermer des espaces dédiés aux dressing ainsi que des niches, à transformer en de vrais placards. Dans cette page et la suivante une vue d'ensemble virtuelle autour d'une composition Cover, permet d'en décrire sa nouveauté absolue de projet. La structure portante, fixée au plafond et au sol, est le noeud du système et contient les charnières invisibles des portes, les montants de fixation des étagères avec intégration du système d'éclairage led à l'intérieur.

Cover es un sistema de hojas batientes de una sola cara que se pueden utilizar para cerrar ambientes finalizados a los vestidores o, en alternativa, para transformar pequeños espacios en armarios contra pared. En esta y en las siguientes páginas: un panorámico virtual alrededor de la composición Cover permite describir mejor la absoluta novedad de concepto. La estructura de soporte, fijada en el techo y en el suelo, es el núcleo del sistema y reúne las bisagras invisibles de las puertas, los montantes de fijación de los estantes con integrado el exclusivo sistema de iluminación interior por leds.



Concezione progettuale  
Design concept



Il progetto Cover rinnova la concezione progettuale della nicchia o dell'armadio a muro, trasformando le ante nell'unico elemento strutturale necessario a cui agganciare l'attrezzatura interna. Come tutti i sistemi Rimadesio, Cover è dotato di una serie di accorgimenti esclusivi, come i montanti muniti di un esclusivo sistema di regolazione invisibile in tre direzioni, che consente una perfetta messa in bolla delle ante, anche con composizioni di grandi dimensioni. L'attrezzatura completa del sistema Cover prevede basi, ripiani estraibili e cassettiere. Tutti gli elementi vengono fissati ai montanti con un sistema ad incastro, senza viti a vista, e la disposizione può essere modificata e variata nel tempo con estrema facilità.

The Cover project renews the design concept of the niche or wardrobe, transforming the doors in the one and only structural element necessary to fix the internal equipment. As all Rimadesio systems, Cover presents some exclusive features such as the uprights equipped with a three direction invisible adjustment system, that allows a perfect leveling of the doors, even with compositions of large dimensions. Cover system accessories include floor bases, shelves, cloth-hanger rods, pull out shelves and drawer units. All the elements are fixed directly to the uprights, without visible screws, and the layout can be modified any time in an easy way.

Das Projekt erneuert das Konzept der Nische oder den Schrankraum. Die Türen sind die einzige strukturelle Elemente wo wird die Innenausstattung fixiert. Wie alle Rimadesio Systeme hat Cover eine exklusive System mit Pfosten, die eine perfekte Nivelierung der Türen erlaubt, auch mit großen Kompositionen. Die Ausstattung des Systems Cover bietet Basisboden, Fachboden, Kleiderstange ausziehbar, Fachboden und Schubladenelemente an. Alle Elemente sind an den Pfosten befestigt mit einem Verbindungssystem ohne sichtbare Schrauben und die Verstellung kann im Laufe der Zeit leicht verändert werden.

Le projet Cover renouvelle la conception d'équiper une niche ou un placard en transformant les portes dans le seul élément structurel nécessaire auquel fixer tous les accessoires à l'intérieur. Comme tous les autres systèmes Rimadesio, Cover est doté d'une série de détails exclusifs, comme les montants, équipés d'un système exclusif de réglage en trois directions, invisible qui permet une parfaite mise à niveau des portes, même avec des grandes compositions. L'équipement complet du système Cover comprend bases au sol, étagères, tiges porte-manteaux, étagères extractibles et bloc tiroirs. Tous les éléments sont fixés aux montants avec un système à encastrement sans vis visibles et la disposition peut être facilement modifiée ensuite.

El proyecto Cover renueva la concepción de proyecto de los espacios pequeños o del armario contra pared, transformando las hojas en el único elemento estructural necesario a los cuales enganchar el equipo interior. Como todos los sistemas Rimadesio, Cover está dotado de una serie de recursos exclusivos, como los montantes que tienen un exclusivo sistema de regulación invisible en tres direcciones, que permiten una perfecta nivelación de las hojas, también en composiciones de grandes dimensiones. El equipo completo del sistema Cover proporciona soportes, estantes, barras colgantes, estantes extraíbles y cajoneras. Todos los elementos se fijan a los montantes con un sistema a encaje, sin tornillos a vista, y la disposición se puede modificar y variar en el tiempo con facilidad extrema.

Caratteristiche tecniche esclusive  
Exclusive technical features

Elementi strutturali  
Structural elements

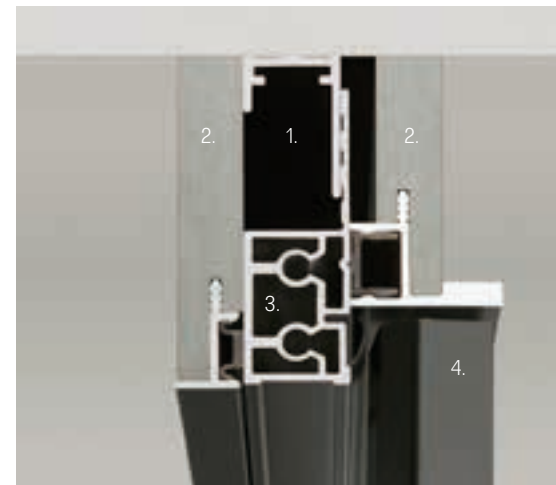

1. Profilo di aggiustaggio a soffitto in estruso di alluminio. Consente la perfetta messa in bolla del traverso e di compensare gli eventuali dislivelli del soffitto. / Ceiling adjusting profile in extruded aluminium. It allows a perfect leveling of the runner and to compensate any possible unevenness of the ceiling.

2. Fasce di aggiustaggio con profilo di supporto in estruso di alluminio e fascia di compensazione in mdf laccato adattabile al vano. Esclusivo sistema di aggancio a scomparsa in nylon. / Structural crosspiece in extruded aluminium, equipped with closing magnets and perimeter joint in pvc, which allows a soft and silent closing.

3. Traverso strutturale in estruso di alluminio, dotato di magneti di chiusura e di guarnizione di battuta in pvc per un movimento di chiusura ammortizzato. Filler with supporting profile in extruded aluminium and adjustment filler in lacquered mdf perfectly adaptable to the opening. Unique concealed nylon fixing system.

4. Pannello porta, struttura in estruso di alluminio e vetro singolo frontale temperato spessore 4 mm. Guarnizione di chiusura in silicone. / Panel door with extruded aluminium structure and single tempered front glass thickness 4 mm. Closing joint in silicone rubber.

5. Montante strutturale in estruso di alluminio, accessorabile con illuminazione a led opzionale. Cerniera incassata brevettata con regolazione micrometrica dell'altezza del pannello. / Extruded aluminium structural runner, which can be equipped with optional led lighting system. Patented recess hinges which allow a micrometric adjusting of the door height.

Sistema di fissaggio degli accessori  
Accessories fixing system



Tutti gli accessori vengono fissati ai montanti con un sistema ad incastro, senza viti a vista, e la disposizione può essere modificata e variata nel tempo con estrema facilità. All the elements are fixed directly to the uprights, without visible screws, and the layout can be modified any time in an easy way.

Maniglie  
Handles

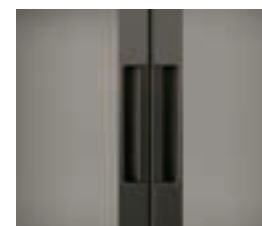

1. 2013 maniglia in pressofusione di zama incassata a filo struttura. / Die-casting aluminium handle.  
2. 2014F / 2014C maniglia in pressofusione di zama con serratura e chiave. Die-casting aluminium handle with hook lock and key.

1.

2.

Storage system

Cover

Tipologie compositive  
Different compositions

Ante battenti  
Hinged doors

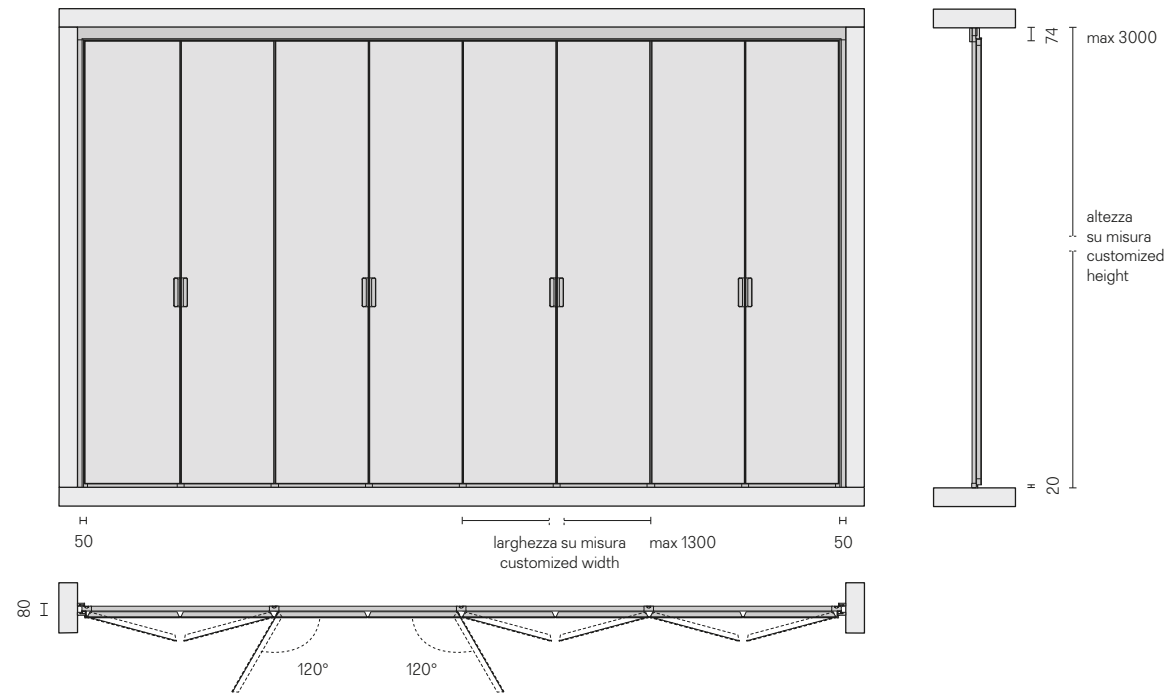

Ante battenti con attrezzatura interna  
Hinged doors with internal equipment

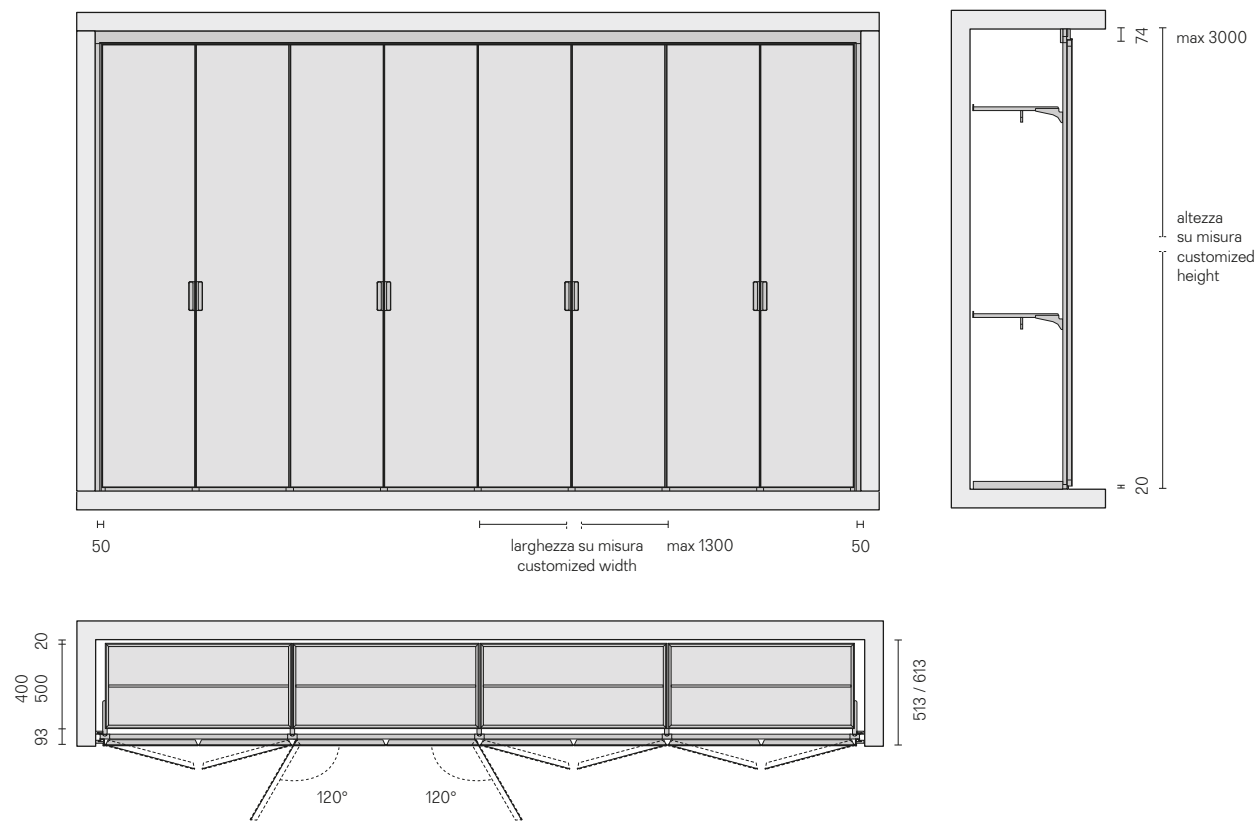

Possibilità di utilizzo  
Possible compositions

Composizione a muro  
Wall composition

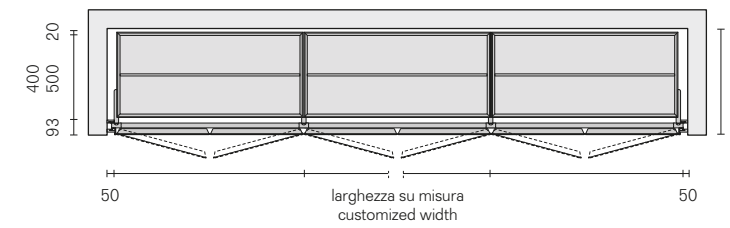

Composizione lineare con fianchi in vetro  
Linear composition with glass panels

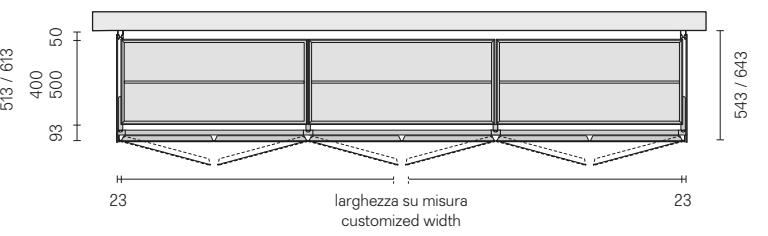

Composizione ad angolo  
Corner composition

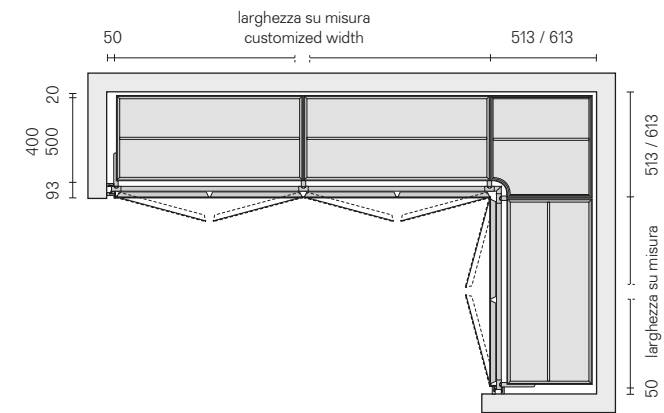

Composizione ad angolo esterno  
Composition with external corner

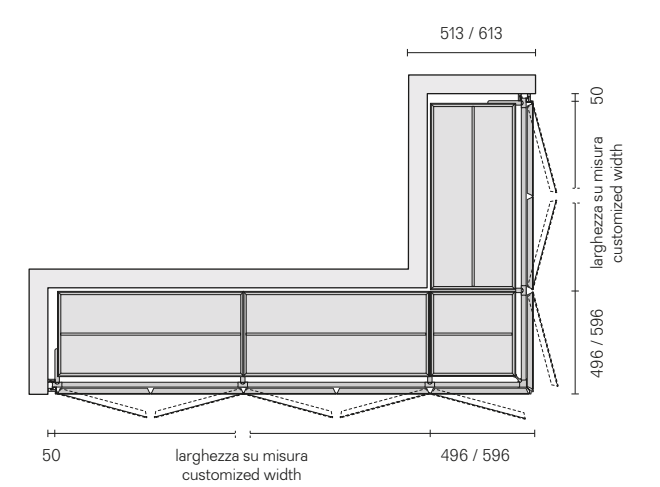

Composizione a C  
C-shaped composition

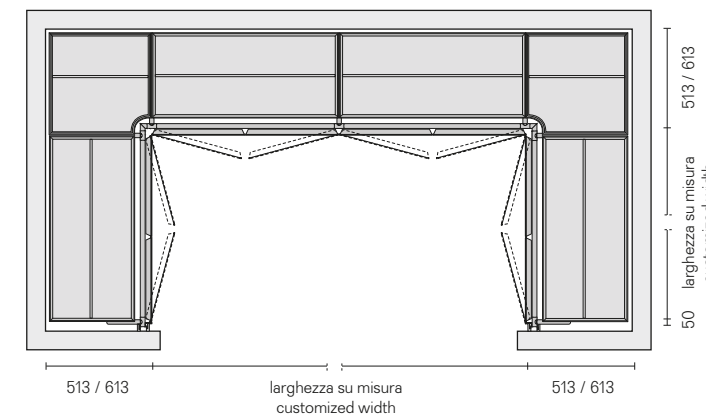

Nicchia attrezzata  
Equipped niche

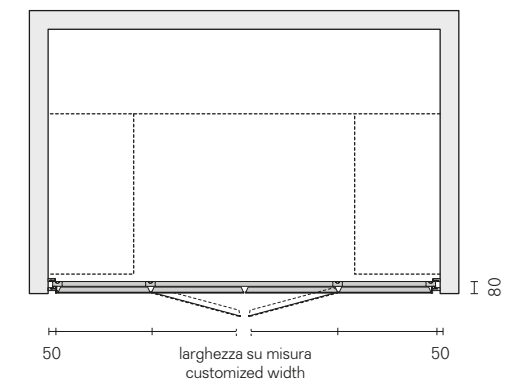

**Modularità e componenti**  
**Modular structure and components**

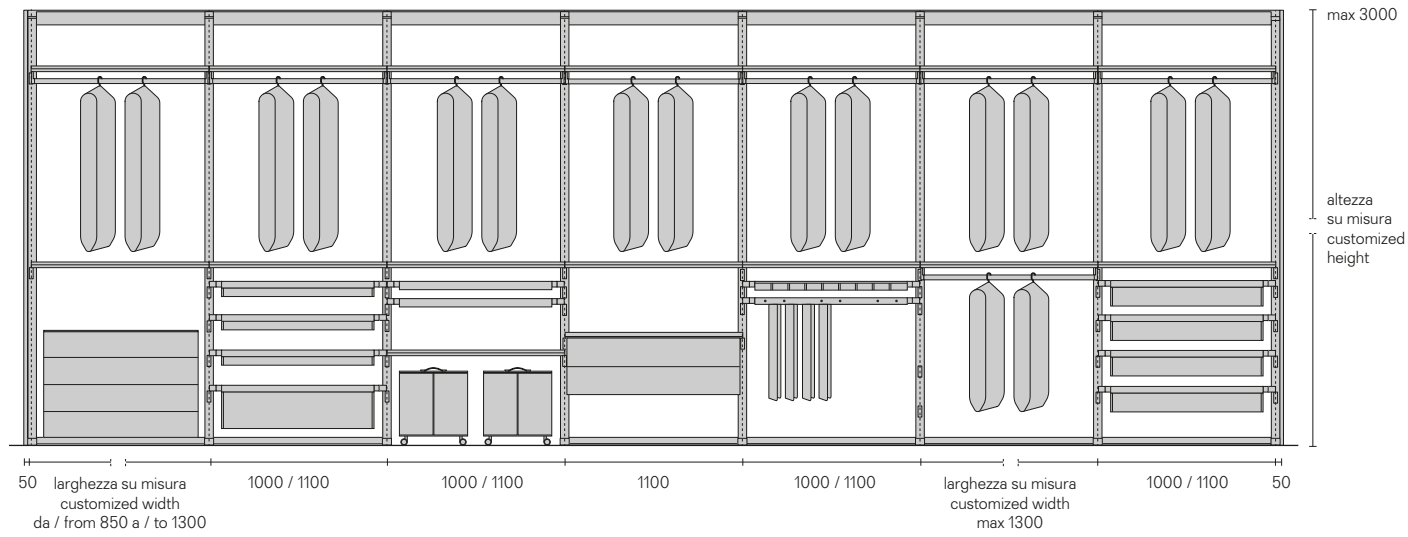

Anta battente con struttura in estruso d'alluminio, disponibile con rivestimento in vetro, gres, tessuto e similpelle. Chiusura con chiave opzionale / Panel door with hinged opening, structure in extruded aluminium, available in glass, gres, fabric and synthetic leather. Key lock on request

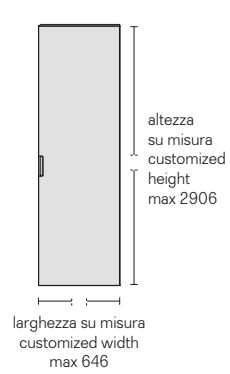

Fianco finale disponibile con rivestimento in vetro temperato, gres, tessuto e similpelle / Terminal panel in tempered glass, gres, fabric and synthetic leather

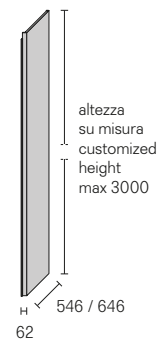

Montante strutturale e montante ad angolo esterno in estruso di alluminio con illuminazione led opzionale. Profilo di aggiustaggio a soffitto e trasverso strutturale / Structural runner and upright for external corner in extruded aluminium, also available with an internal led lighting system. Ceiling adjusting profile and structural crosspiece

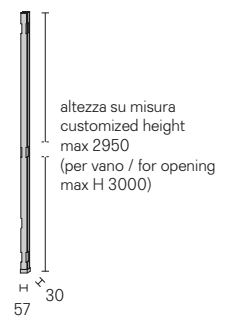

Fasce di aggiustaggio laterali e superiori, anteriori e posteriori / Lateral and upper, front and back fillers

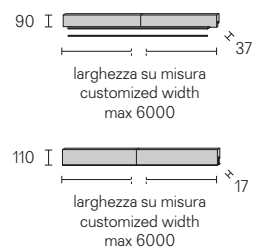
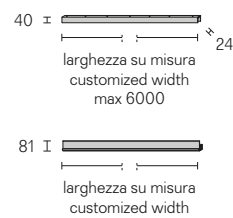
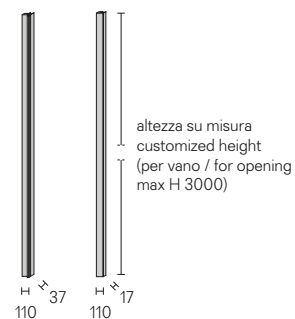

**Accessori**  
**Accessories**

Ripiano estraibile con vaschetta in similpelle / Pull out shelf with tray in synthetic leather finishing

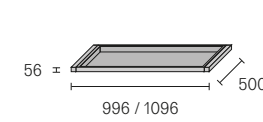

Contenitore in essenza di noce Walnut veneered organizer

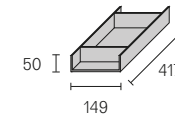

Separatore doppio Organizer with double partition

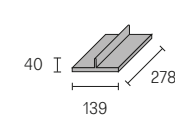

Porta orologi / Watch holder

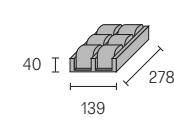

Vaschetta concava e vaschetta con fessure / Concave box and box with jewels slots

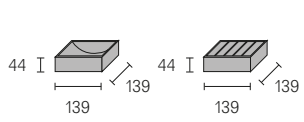

Ripiano estraibile con portapantaloni e vani per cinture in similpelle / Pull out shelf with trousers rack and belts tray in synthetic leather finishing

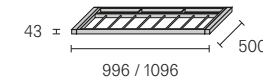

Ripiano estraibile portacravatte in similpelle / Pull out shelf with tie rack in synthetic leather finishing

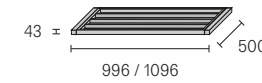

Ripiano estraibile portascarpe in similpelle / Pull out shelf with shoe rack in synthetic leather finishing

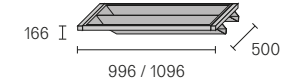

Ripiano estraibile con organizer in similpelle / Pull out shelf with organizer tray in synthetic leather finishing

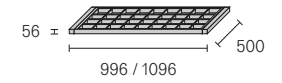

Cesto basso estraibile in similpelle / Pull out small tray in synthetic leather finishing

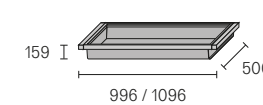

Cesto alto estraibile in similpelle / Pull out big tray in synthetic leather finishing

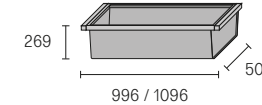

Asta portabiti per mensola con rivestimento opzionale in similpelle / Cloth hanger for shelf with optional cover in synthetic leather

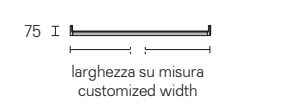

Cesta e vassoio in similpelle Synthetic leather box and tray

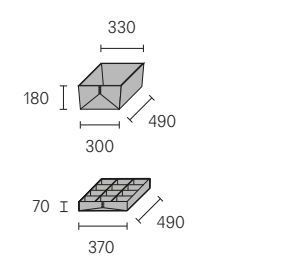

Contenitore su ruote in similpelle / Cabinets on wheels in synthetic leather finishing

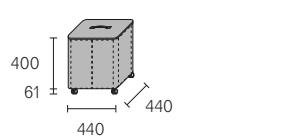

Basamento in legno laccato o in melaminico / Base in lacquered wood or melamine

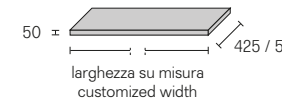

Mensola in melaminico con profilo posteriore in alluminio Melamine shelf with rear aluminium profile

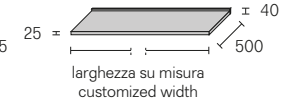

Mensola in vetro con ring in alluminio e top opzionale in similpelle / Glass shelf with aluminium ring and optional top in synthetic leather finishing

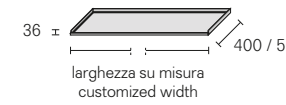

Cassettiera sospesa in legno laccato o melaminico, top in specchio grigio. Top opzionale in similpelle / Suspended drawer unit in lacquered wood or melamine, top in gray mirror. Optional in synthetic leather

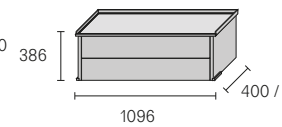

Cassettiera per basamento, o su ruote, in melaminico larice carbone con tre cassetti / Drawer unit, or on wheels, in melamine coal larch with three drawers

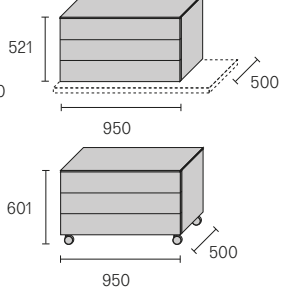

Cassettiera per basamento, o su ruote, in vetro laccato o in melaminico con quattro cassetti / Drawer unit, on wheels in lacquered glass or in melamine with four drawers

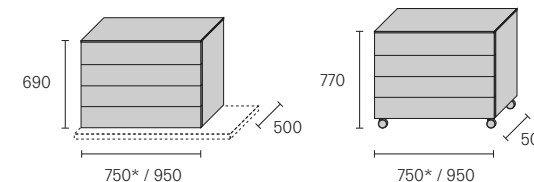

Top opzionale in melaminico larice carbone con fondo rivestito in similpelle, per cassetteria su basamento o su ruote / Optional top in coal larch melamine with bottom part covered with synthetic leather, for drawer units on base or on castors

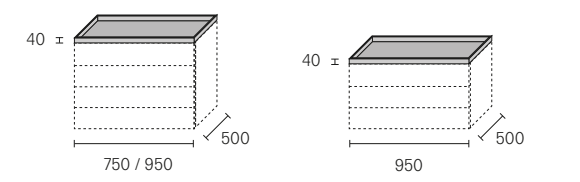

Tovaglietta opzionale in similpelle per fondo cassetti / Optional synthetic leather mat for drawer bottom



\* Larghezza disponibile solo in vetro e in melaminico larice carbone / Width only available in glass and coal larch melamine





Design Giuseppe Bavuso

## Cover freestanding

Cover freestanding is the self-supporting version of the Cover system, therefore equipped with side and back panels to allow the definition of always custom made linear or corner compositions. The perfect finishing of the backpanels and of the inside of the doors make Cover freestanding an ideal system also for niche solutions, also combined with integrated through-way. The internal structures are fixed directly to the uprights without visible screws, which allows a free and easily adjustable arrangement.

Cover freestanding è la versione autoportante del sistema Cover, dotato quindi di fianchi laterali e pannelli schienali per consentire la definizione di composizioni lineari o con angoli, sempre a misura. La perfetta finitura degli schienali e dell'interno delle ante rendono Cover freestanding un sistema ideale anche per soluzioni interparete, completo di passaggi integrati. Le attrezzature interne vengono fissate ai montanti con un sistema ad incastro, senza viti a vista, che consente una disposizione libera e modificabile nel tempo con estrema facilità.

Cover freestanding ist die selbsttragende Version des Cover Systems, das daher mit Seitenteilen und Rückwänden ausgestattet ist, um lineare oder eckige Kompositionen auf Maß zu definieren. Das perfekte Finish der Rückenlehnen und der Türinnenseiten macht Cover freestanding zu einem idealen System auch für Zwischenwandlösungen mit integrierten Durchgängen. Die inneren Befestigungen sind an den Pfosten mit einem Verriegelungssystem ohne sichtbare Schrauben befestigt, was eine freie und leicht modifizierbare Anordnung im Laufe der Zeit ermöglicht.

Cover freestanding est la version autoportante du système Cover, donc équipé de panneaux latéraux et de panneaux de fond pour permettre la définition de compositions linéaires ou en angle, toujours sur mesure. La finition parfaite des panneaux de fond et de l'intérieur des portes permettent à Cover de devenir un système idéal aussi pour les solutions inter-murs, avec des passages intégrés. Les équipements internes sont fixés aux montants avec un système à encastrement, sans vis visibles, avec libre disposition, qui peut être facilement modifiée ensuite.

Cover freestanding es la versión autoportante del sistema Cover, equipada por lo tanto de paneles laterales y paneles traseros para permitir la definición de composiciones lineales o en ángulo, siempre a medida. El perfecto acabado de los paneles traseros y del interior de las puertas hacen de Cover freestanding un sistema ideal también para soluciones entre paredes, completo de hueco de pasos. Los elementos accesorios internos se fijan a los montantes con un sistema de enganche, sin tornillos visibles, que permite una disposición libre y modificable en el tiempo con extrema facilidad.

Struttura Structure: 304 platino  
Vetro Glass: 67 riflettente chiaro  
Basamento e top  
Floor base and top: 09 melaminico rovere grigio  
Mensole Shelves: 63 grigio trasparente  
Cassettiere Drawers: 09 melaminico rovere grigio  
Top cassettiere Drawers top: 154 similpelle argilla

Nella foto In this photo  
Tavolo Table: Manta  
Tavolino Coffee table: Planet  
Porta Door: Moon







In alluminio e vetro, completamente autoportante, Cover freestanding rappresenta la naturale evoluzione del sistema Cover. Liberamente componibile e adattabile agli spazi con la massima precisione grazie al servizio su misura, Cover freestanding rappresenta un concentrato di innovazione tecnologica e funzionale, una soluzione evoluta alle esigenze progettuali degli spazi contemporanei. L'organizzazione dello spazio interno è risolto con una serie di componenti e soluzioni che associano essenzialità del design, massima praticità e ricercatezza.

In aluminium and glass, totally self-supporting, Cover freestanding represents the natural evolution of the Cover system. Completely modular and adaptable to spaces with a maximum precision, thanks to its customization, Cover freestanding is a concentrate of technological and functional innovation, a solution evolved to the needs of the contemporary spaces. The organization of the interior space is achieved through different accessories and possible solutions, combining essential design, maximum practicality and refinement.

Aus Aluminium und Glas, vollständig selbsttragende, Cover freestanding stellt die natürliche Entwicklung des Systems Cover dar. Frei modular und immer nach Mass passt sich Cover massgenau an jeden Raum, dank der maßgeschneiderten Service, mit der Verbindung der technologischen Innovation und Funktionalität, um Lösungen fuer jeden modernen Wohnbereich anzubieten. Die Organisation des Innenraums ist mit einem ausreichenden Wahl von Zubehoeren geloeset mit der Verbindung von wesentlichen Design, maximale Funktionalität und Finesse.

En aluminium et verre, entièrement auto-portante, Cover freestanding représente l'évolution naturelle du système Cover. Librement modulables et adaptables aux différents espaces avec une précision maximale grâce au sur mesure, Cover freestanding représente une concentration de l'innovation technologique et fonctionnelle, une solution sophistiquée pour les exigences de conception des espaces contemporains. L'organisation de l'espace intérieur est résolu avec un ensemble d'accessoires et de solutions, qui combinent le design essentiel, une forte fonctionnalité et style recherché.

Aluminio y vidrio, Cover freestanding es totalmente auto-portante y representa la natural evolución del sistema Cover. Libremente componible y adaptable a los espacios con la máxima precisión gracias al servicio de personalización a medida, Cover freestanding es un concentrado de la innovación tecnológica y funcional, una solución evolucionada para necesidades de proyecto de los espacios contemporáneos. La organización del espacio interior se resuelve con un conjunto de componentes y soluciones que combinan un diseño esencial a la máxima practicidad y sofisticación.







Concezione progettuale  
The design concept



Un sistema armadio di ultima generazione, nel quale tutti i componenti, dalle ante agli accessori, dalla struttura ai complementi, sono realizzati su misura grazie a un sistema di produzione "custom-made". Le alte prestazioni di Cover freestanding nascono da una struttura in alluminio tecnologicamente innovativa. I montanti, su cui si regolano le ante ospitano l'illuminazione a led. Il sistema prevede la versione freestanding, con lato posteriore e fianchi completamente rifiniti, oppure la versione interparete, con fasce di aggiustaggio opzionali superiori e laterali, per chiudere gli eventuali fuori squadra delle pareti.

A storage system of the latest generation, where all components, from doors to accessories, from the structure to the complements, are realized custom-made. The high performances of Cover freestanding comes from an aluminium technological advanced structure. The uprights, on which the doors are adjusted, conceal the led lighting. The system provides the freestanding version, with sides and back panels completely well finished, or the version between the walls, with optional adjusting fillers for both sides and top, to close eventual differences in the wall.

Ein Schranksystem der nächsten Generation, in dem alle Komponenten, von den Platten bis zum Zubehör, von der Struktur bis zu den Zusätzen dank eines Produktionssystem individuell nach Maß gefertigt werden. Der hohe Leistungsumfang des Cover Freestanding ergibt sich aus einer technologisch innovativen Aluminiumstruktur. Die Stände, auf dem die Platten angepasst werden, verfügen über eine LED-Beleuchtung. Das System sieht die Version freestanding mit vollständig geschlossenen Rückseiten und Seiten vor. Alternativ gibt es die Ausführung "interparete", mit optionaler obiger und seitlicher Einstellung der Wände.

Un système armoire de nouvelle génération, dans lequel tous les composants, des portes aux accessoires, de la structure aux compléments, sont fabriqués grâce à un système de production "sur mesure". Les hautes performances de Cover freestanding proviennent d'une structure en aluminium technologiquement innovante. L'éclairage led peut être installé sur les montants, qui règlent les portes. Le système est disponible en version freestanding avec l'arrière et les côtés complètement finis, ou en version entre murs avec fileurs lateraux et supérieurs optionnels, pour fermer les différences d'épaisseur de parois

Un sistema armario de última generación, en el cual todos los componentes, de las puertas a los elementos accesorios, de la estructura hasta los complementos, son realizados a medida, gracias a un sistema de producción "custom-made". El alto rendimiento de Cover freestanding surgen de una estructura en aluminio tecnológicamente innovadora. Los montantes en los cuales se ajustan las puertas acomodan una iluminación por leds. El sistema prevé la versión freestanding, con parte trasera y paneles laterales completamente acabados, o la versión interparete, con bandas de ajuste opcionales superiores y laterales, para cerrar cualquier descuadre de las paredes.

Caratteristiche tecniche esclusive  
Exclusive technical features

Sistema di fissaggio degli accessori  
Accessories fixing system



Tutti gli accessori vengono fissati ai montanti con un sistema ad incastro, senza viti a vista, e la disposizione può essere modificata e variata nel tempo con estrema facilità. All the elements are fixed directly to the uprights, without visible screws, and the layout can be modified any time in an easy way.

Maniglie  
Handles

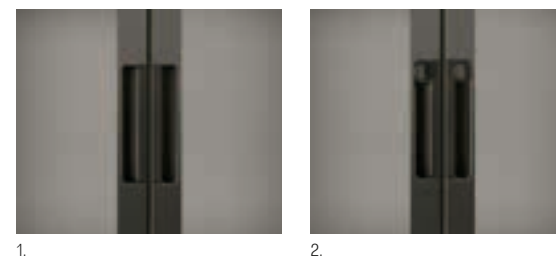

1. 2013 maniglia in pressofusione di zama incassata a filo struttura. / Die-casting aluminium handle.
2. 2014F / 2014C maniglia in pressofusione di zama con serratura e chiave. Die-casting aluminium handle with hook lock and key.



Tipologie compositive  
Different compositions

Centro stanza  
Middle room

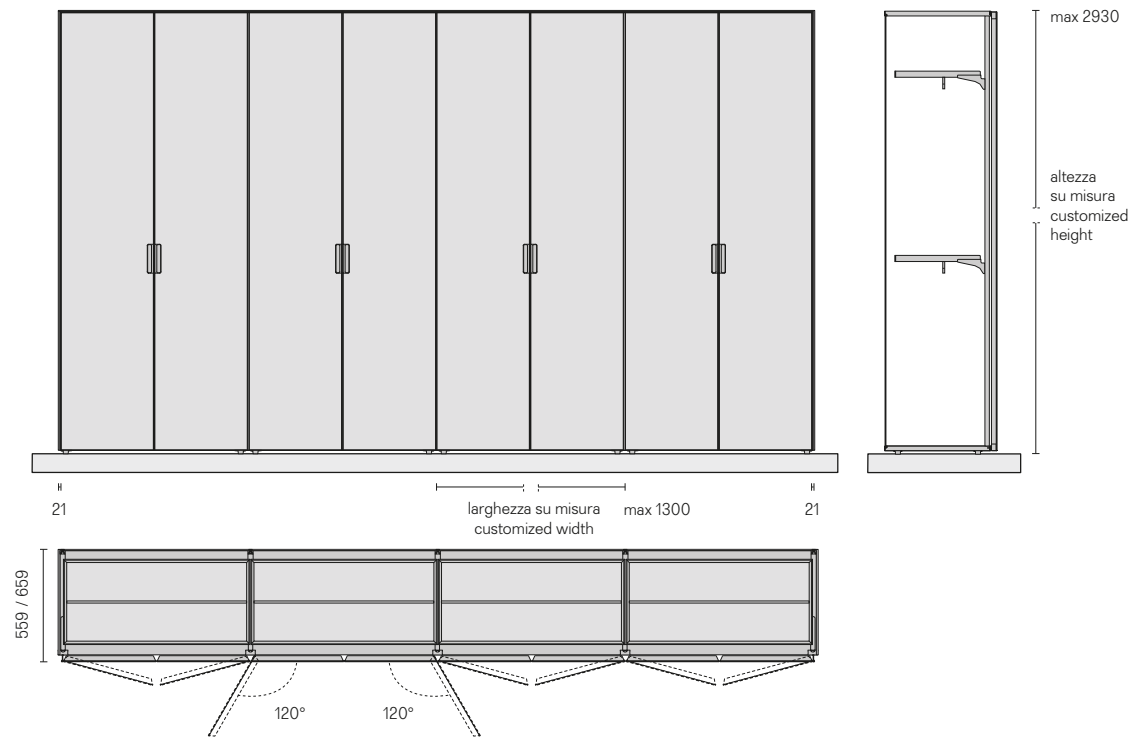

Interparete  
Niche

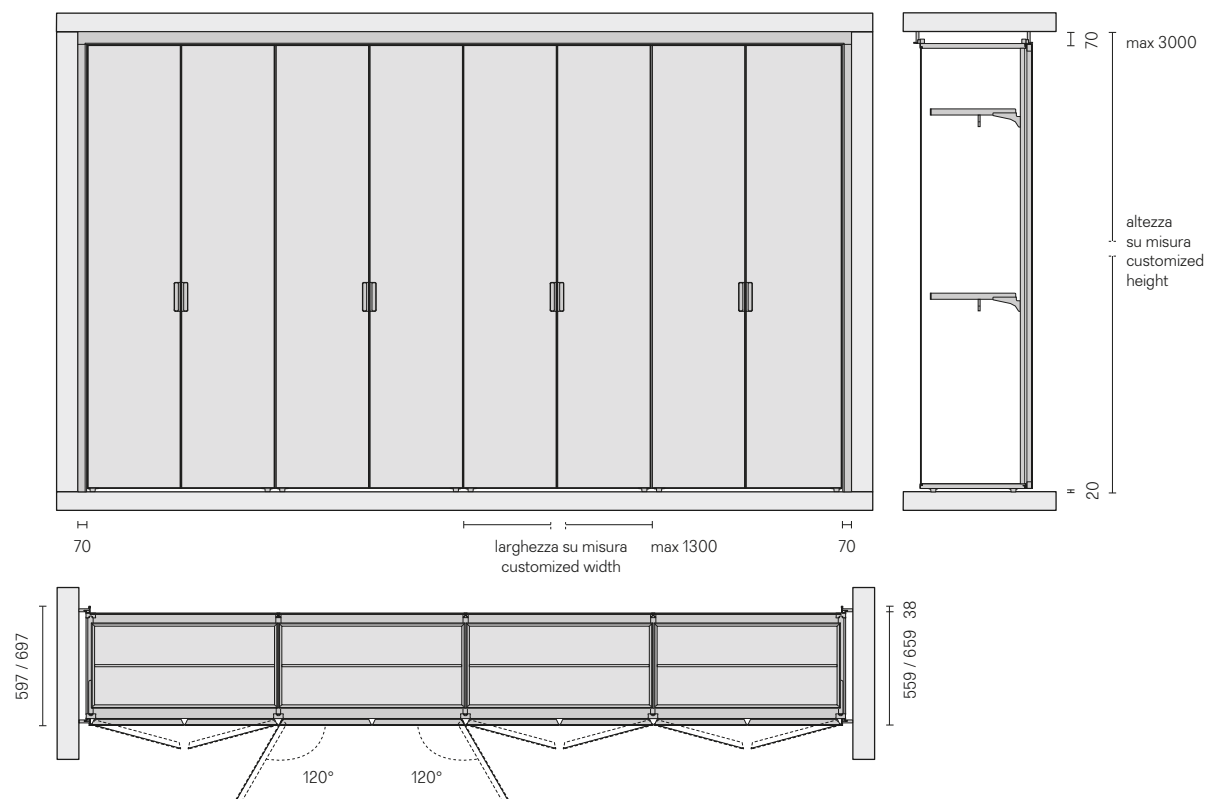

Possibilità di utilizzo  
Possible compositions

Composizione centro stanza  
Freestanding composition

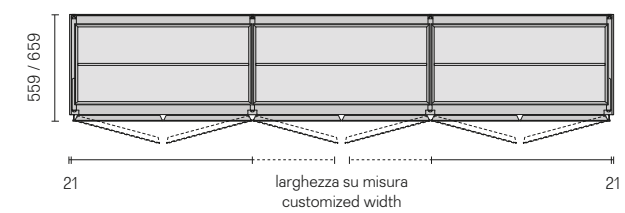

Composizione interparete  
Composition next to the wall

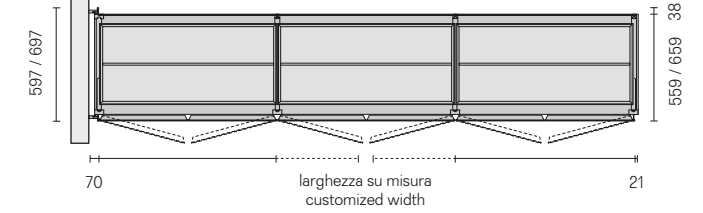

Composizione interparete con vano di passaggio  
Niche composition with through-way

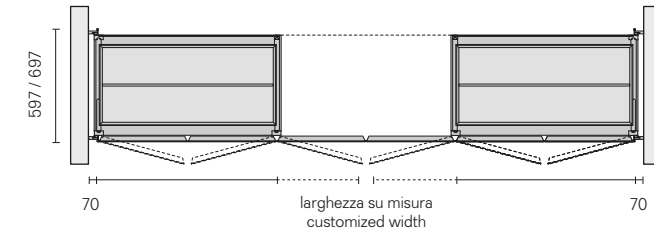

Composizione interparete con vano di passaggio e ante contrapposte  
Niche composition with through-way and counterposed doors

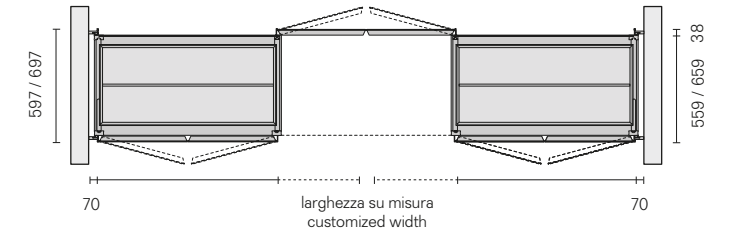

Composizione interparete con vano di passaggio laterale  
Composition in niche with side passage opening

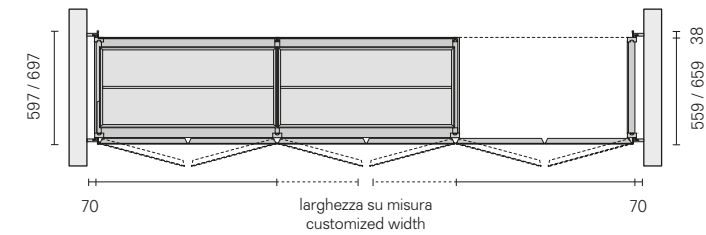

Composizione interparete con vano di passaggio laterale e ante contrapposte  
Composition in niche with side passage opening and opposing doors

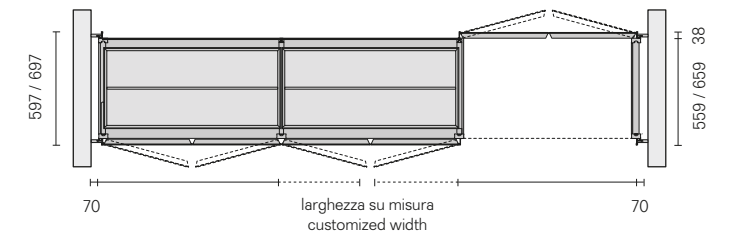

Composizione ad angolo  
Corner composition

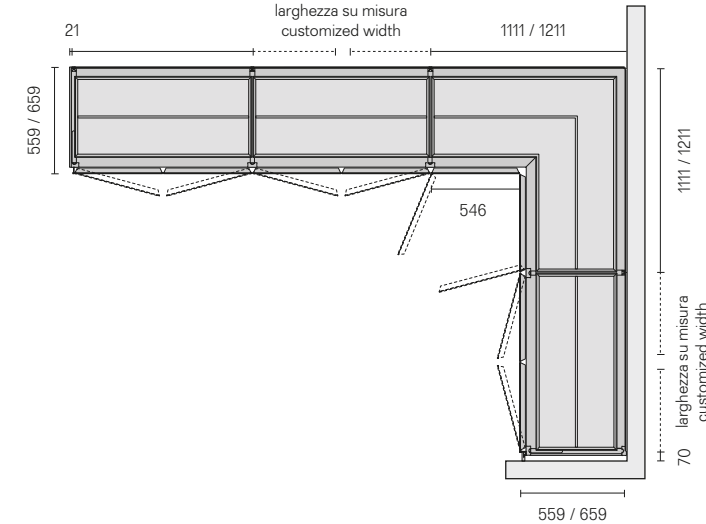

Composizione a C  
C composition

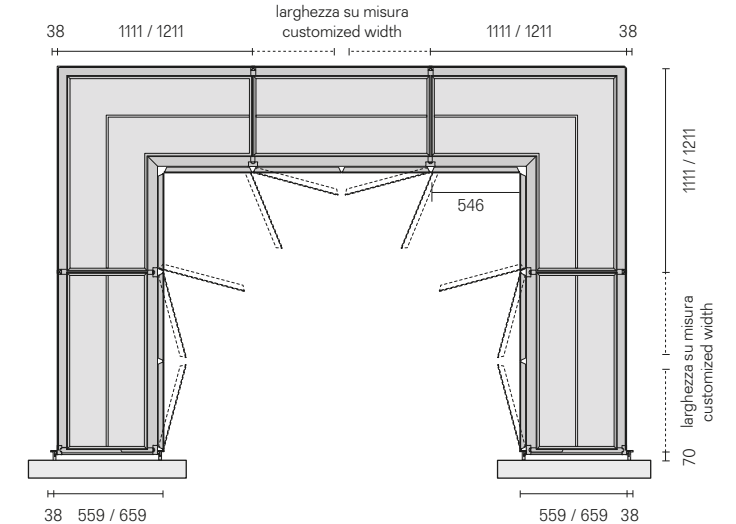

**Modularità e componenti**  
**Modular structure and components**

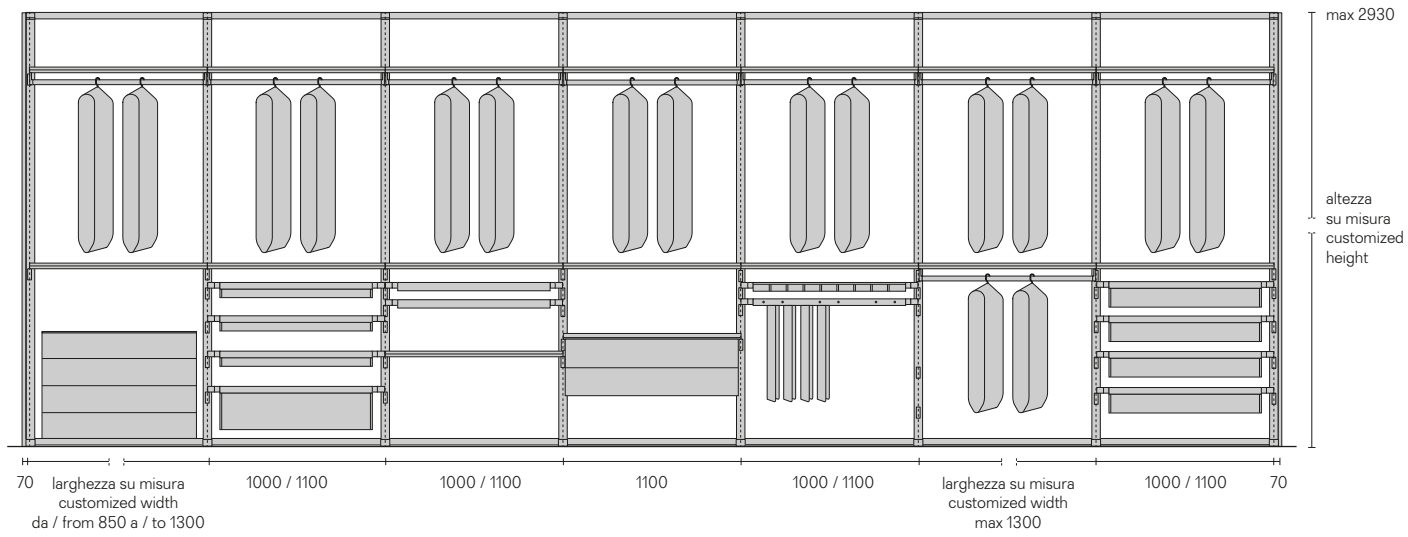

Anta battente con struttura in estruso d'alluminio, disponibile con rivestimento in vetro singolo frontale temperato spessore 4 mm, gres, tessuto e similpelle. Chiusura con chiave opzionale / Panel door with hinged opening, structure in extruded aluminium available with single 4 mm thick tempered glass, gres, fabric and synthetic leather fronts. Key lock on request

Fianco finale sp 48 mm, fianco intermedio sp 53 mm e fianco di passaggio spessore 53 mm. Illuminazione a led opzionale anteriore e posteriore. Disponibile con rivestimento in vetro singolo frontale temperato spessore 4 mm, gres, tessuto e similpelle / Closing side panel thickness 48 mm, intermediate side panel thickness 53 mm and side panel for through-way thickness 53 mm. Optional front and rear led lighting system available with single 4 mm thick tempered glass, gres, fabric and synthetic leather fronts

Schienale in vetro temperato spessore 6 mm, disponibile nei vetri laccati, trasparenti e satinati / Back panel in tempered glass thickness 6 mm, available in lacquered, transparent and satined glass

Fasce di aggiustaggio laterali e superiori, anteriori e posteriori / Lateral and upper, front and back fillers

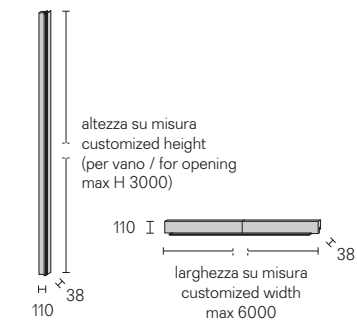
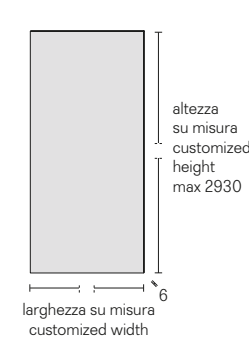
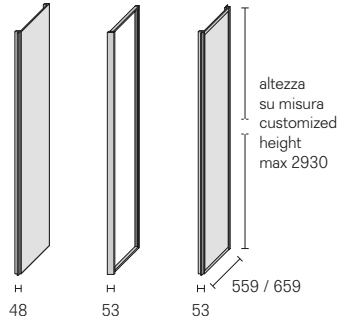
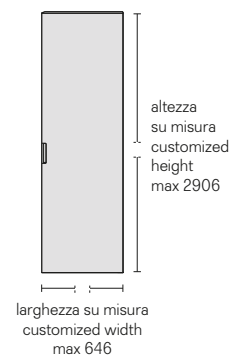

Basamento e top in melaminico  
 Floor base and top in melamine

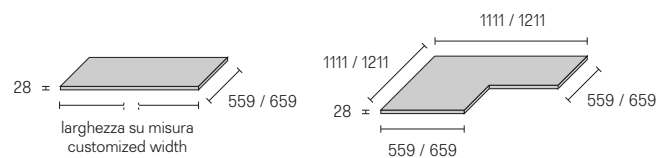

**Componenti**  
**Components**

Ripiano estraibile con vaschetta in similpelle / Pull out shelf with tray in synthetic leather finishing

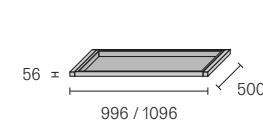

Contenitore in essenza di noce  
 Walnut veneered organizer

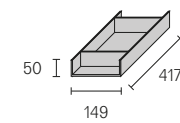

Separatore doppio / Organizer with double partition

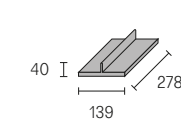

Porta orologi / Watch holder

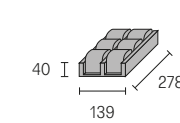

Vaschetta concava e vaschetta con fessure / Concave box and box with jewels slots

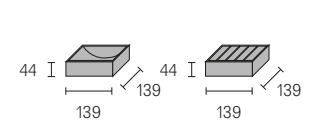

Ripiano estraibile con portapantaloni e vani per cinture in similpelle / Pull out shelf with trousers rack and belts tray in synthetic leather finishing

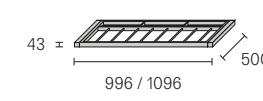

Ripiano estraibile portacravatte in similpelle / Pull out shelf with tie rack in synthetic leather finishing

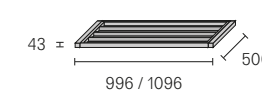

Ripiano estraibile portascarpe in similpelle / Pull out shelf with shoe rack in synthetic leather finishing

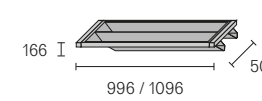

Ripiano estraibile con organizer in similpelle / Pull out shelf with organizer tray in synthetic leather finishing

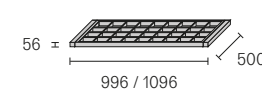

Cesta e vassoio in similpelle  
 Synthetic leather box and tray

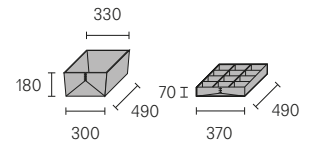

Cesto basso e cesto alto estraibili in similpelle / Pull out small and big trays in synthetic leather finishing

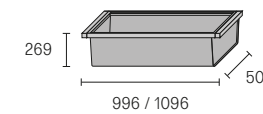
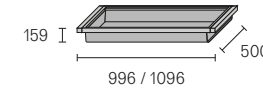

Mensola in melaminico con profilo posteriore in alluminio / Melamine shelf with rear aluminium profile

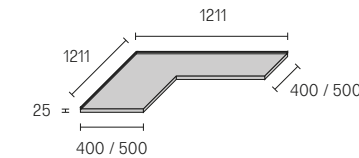
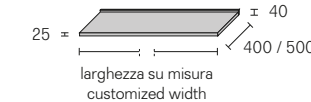

Mensola in vetro con ring in alluminio e top opzionale in similpelle / Glass shelf with aluminium ring and optional top in synthetic leather finishing

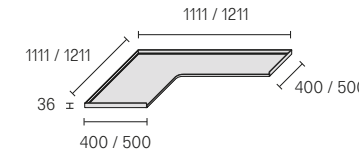
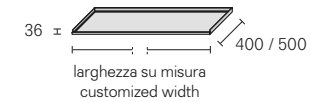

Asta portabiti per mensola e sottotop con rivestimento opzionale in similpelle  
 Cloth hanger for shelf and undertop with optional cover in synthetic leather

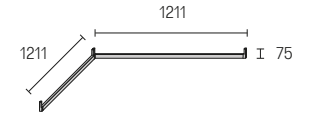
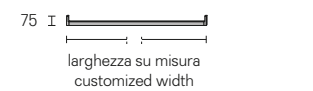

Cassettiera sospesa in legno laccato o melaminico, top in specchio grigio. Top opzionale in similpelle  
 Suspended drawer unit in lacquered wood or melamine, top in gray mirror. Optional top in synthetic leather

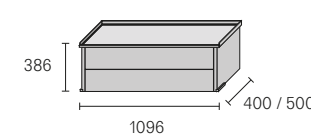

Cassettiera per basamento. In melaminico con tre cassetti, in vetro laccato o in melaminico con quattro cassetti  
 Drawer unit on floor base. In melamine with three drawers, in lacquered glass or in melamine with four drawer

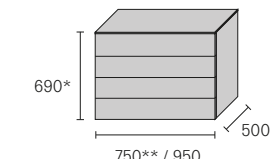
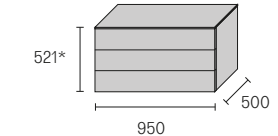

Top opzionale in melaminico larice carbone con fondo rivestito in similpelle, per cassetteria su basamento  
 Optional top in coal larch melamine with bottom part covered with synthetic leather, for drawer units on floor base

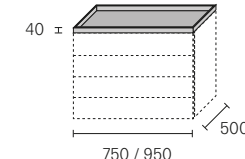
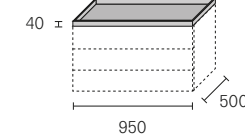

Tovaglietta opzionale in similpelle per fondo cassetti  
 Optional synthetic leather mat for drawer bottom

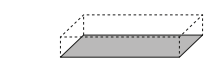

\* Altezza disponibile solo in melaminico larice carbone / Height only available in melamine coal larch  
 \*\* Larghezza disponibile solo in vetro e in melaminico larice carbone / Width only available in glass and coal larch melamine

# Day collection

279 Zenit, 287 Opus, 293 Wind, 303 Alambra,  
327 Self, 335 Self bold, 349 Self up, 363 Abacus living



Design Giuseppe Bavuso

## Zenit

The iconic bookcase of the Rimadesio collection in the pursuit of lightness and project versatility. The uprights, fixed from floor to ceiling and always custom-made, allow a free positioning of the elements, in the desired number and at the desired height. The exclusive hooking system element guarantees the maximum structural solidity and allows to level every element.

La libreria all'insegna della leggerezza e della versatilità compositiva. I montanti, fissati da terra a soffitto e sempre su misura, permettono una libera disposizione delle attrezzature, nel numero e all'altezza desiderata. Un progetto versatile, pensato per esporre e contenere, destinato alla casa e agli spazi professionali. La varietà delle finiture, dal vetro alle essenze fino alle superfici in alluminio, consente una perfetta integrazione stilistica in ogni ambiente.

Das Bücherregal zeichnet sich durch Leichtigkeit und Vielseitigkeit aus. Die in Sondermaßen Pfosten, vom Boden bis zum Decke fixiert, ermöglichen dem Kunden eine freie Anordnung der Ausrüstung, in der gewünschten Anzahl und Höhe. Dies ist ein vielseitiges, für den häuslichen und professionellen Raum bestimmtes Modell, das entworfen wurde, um hergezeigt zu werden und um etwas zu verstauen. Die Vielfalt an Oberflächenmaterialien, von Glas über Holz bis zu den Aluminiumoberflächen, ermöglicht eine perfekte stilistische Integration in jeder Umgebung.

La bibliothèque caractérisée par la légèreté et la polyvalence de la composition. Les montants, fixés du sol au plafond et toujours sur mesure, permettent une disposition libre de l'équipement, dans le nombre et à la hauteur désirées. Un projet polyvalent, conçu pour exposer et contenir, destiné à la maison et aux espaces professionnels. La variété des finitions, du verre au bois, aux surfaces en aluminium, permet une intégration stylistique parfaite dans chaque environnement.

La librería se caracteriza por su ligereza y versatilidad compositiva. Los montantes, fijados al suelo y techo y siempre a medida, permiten una disposición libre del equipamiento, en el número y altura deseados. Un proyecto versátil, diseñado para exhibir y contener, destinado para el hogar y espacios profesionales. La variedad de acabados, del vidrio a las esencias y superficies de aluminio, permite una perfecta integración estilística en cualquier entorno.

Struttura Structure: 69 palladio  
Mensole in vetro Glass shelves: 62 rete bronzo  
W 4800 H 2740 D 340





**Modularità**  
**Modular structure**

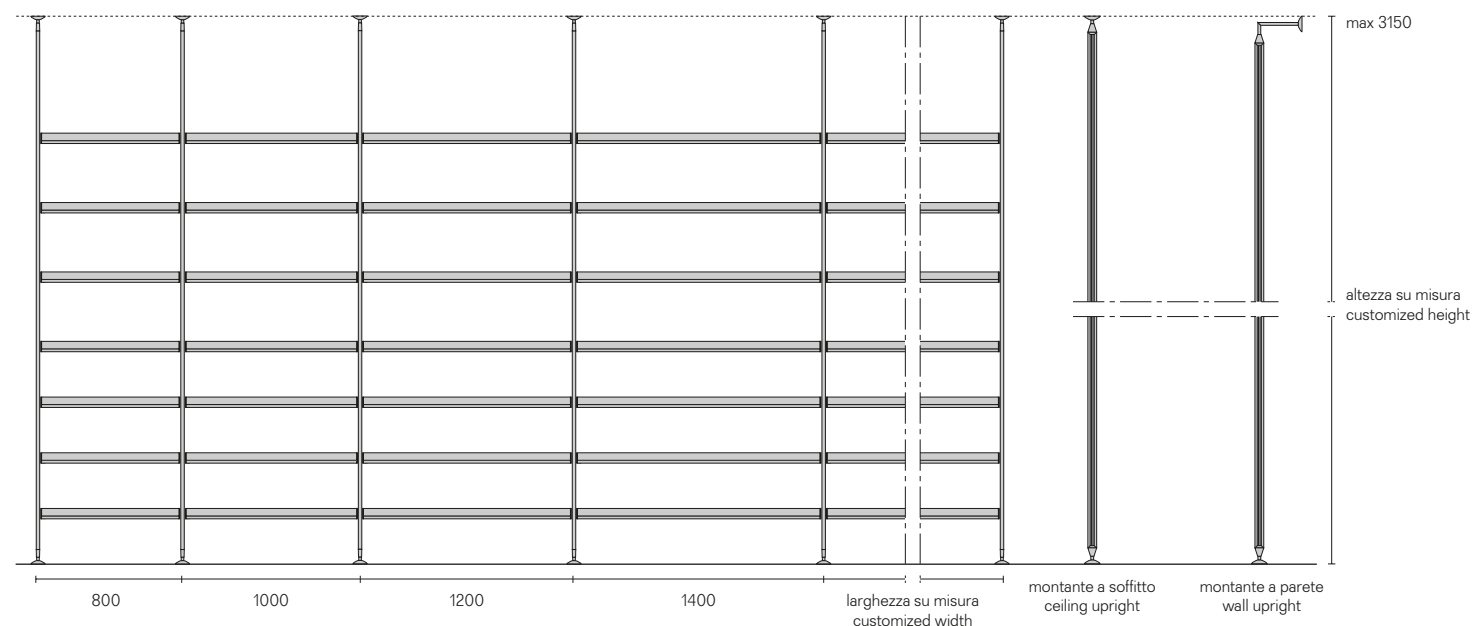

Ingombri composizione con solo mensole  
Encumbrance of the composition with shelves only

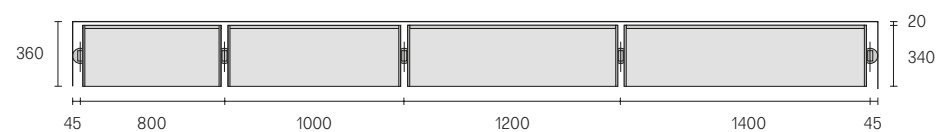

Ingombri composizione lineare con cassetiera e mensolone tv/HiFi  
Encumbrance of the linear composition with drawer unit and tv/HiFi top shelf holder

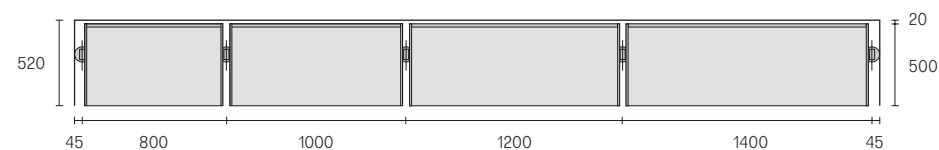

**Descrizione tecnica**  
**Technical description**

Le composizioni Zenit vengono sempre realizzate su misura in altezza, con possibilità di montanti a parete o a soffitto. Le mensole e i mensoloni sono disponibili in quattro larghezze, fino alla dimensione massima di 140 cm, con inoltre la possibilità di riduzione a misura in larghezza. Tutti gli altri componenti sono disponibili solo nella larghezza indicata.

Zenit compositions are always custom-made in height, with wall or ceiling uprights. Shelves and shelf holders are available in four widths, up to a maximum size of 140 cm, with the possibility to reduce on size in width. All other components are only available in the indicated width.

Zenit Anlage sind immer nach Mass in Hoehe, mit Wand oder Decke-Pfosten hergestellt. Fachboeden und Top-Fachboeden sind mit vier Breiten verfuegbar in laenghe, bis zu einer maximalen Breite von 140 cm. Es is auch moeglich sie nach Mass zu kuerzen. Die andere Zubehoeren sind nur mit der angegebenen Breite verfuegbar.

Les compositions Zenit sont toujours sur mesure en hauteur, avec les montants à fixation murale ou au plafond. Les étagères, et les étagères base sont disponibles en quatre largeurs, jusqu' à une dimension maxi de 140 cm, avec la possibilité de les réduire sur mesure in larghezza. Tous les autres accessoires sont disponibles seulement dans la dimension indiquée.

Las composiciones Zenit están siempre realizadas a medida en altura, con posibilidad de montantes a pared o a techo. Los estantes, y los estantes base están disponibles en cuatro anchuras, hasta el tamaño máximo de 140 cm, con la posibilidad de reducción a medida in larghezza. Los otros accesorios están disponibles sólo en la anchura indicada.

**Componenti**  
**Components**

Mensolone attrezzato per tv-HiFi con ripiano inferiore porta decoder  
TV-HiFi shelf base with bottom shelf for decoder



1. Vetro temperato laccato opaco caffè. / Caffè mat tempered lacquered glass.
2. Canalina passacavi in finitura alluminio brown. / Cable duct in brown aluminium finish.
3. Ripiano porta decoder in alluminio laccato. / Bottom shelf for decoder in aluminium.

Cassetiera sospesa  
Suspended drawer unit



1. Maniglia in finitura alluminio brown. / Handle in brown aluminium finish.
2. Struttura interna del cassetto in melaminico cuoio brown. Guide ad estrazione totale con autorientro silenzioso. Drawer's internal leather structure in brown melamine. Totally extractable runners with soft closing device.
3. Vetro temperato laccato opaco caffè. / Caffè mat tempered lacquered glass.

Mensola in vetro temperato con ring in alluminio  
Tempered glass shelf with aluminium ring

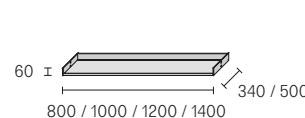

Mensolone attrezzato per tv-HiFi in vetro laccato con struttura e canalina passacavi in alluminio  
Tv-HiFi base shelf in lacquered glass with aluminium structure and cable channelling

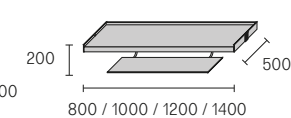

Cassetiera sospesa in vetro laccato con struttura in alluminio / Lacquered glass suspended drawers unit with aluminium structure

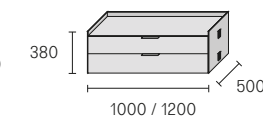

Vetrina sospesa in vetro temperato con ante scorrevoli  
Suspended showcase in tempered glass with sliding shutters

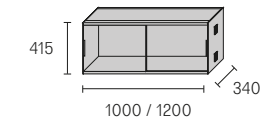

Tovaglietta opzionale in similpelle per fondo cassetti  
Optional synthetic leather mat for drawer bottom

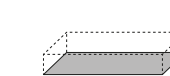





Design Giuseppe Bavuso

## Opus

A modular bookcase system, entirely in extruded aluminium, based on the free composition of square and rectangle as modular shapes. A rigorous geometric idea which allows to create bookcases of different dimensions with a strong scenographic value. Perfectly double-sided, equipped with drawers or flap doors units, Opus decorates with personality house or professional spaces.

Un sistema libreria componibile, interamente in alluminio estruso, basato sulla libera composizione del quadrato e del rettangolo come figure modulari. Una concezione geometrica rigorosa che consente la definizione di librerie di varie dimensioni dal forte valore scenografico. Perfettamente bifacciale, attrezzabile con contenitori a cassetti o ante a ribalta, Opus si presta ad arredare con personalità ambienti domestici o professionali.

Opus ist ein modulares, komplett aus extrudiertem Aluminium hergestelltes Bücherregalsystem, das auf der freien Zusammenstellung von Quadraten und Rechtecken als modulare Figuren beruht. Es entsteht dadurch ein strenges geometrisches Konzept, das die Definition von Bibliotheken verschiedener Dimensionen mit einem starken szenographischen Wert ermöglicht. Dieses zweiseitige Regal kann mit Schubladen oder Klapptüren ausgestattet werden und eignet sich für die persönliche Einrichtung des Zuhauses oder der beruflichen Umgebung.

Un système de bibliothèque modulaire, entièrement en aluminium extrudé, basé sur la composition libre du carré et du rectangle comme figures modulaires. Un concept géométrique rigoureux qui permet la définition de bibliothèques de différentes dimensions avec une forte valeur scénographique. Parfaitement bifacial, Opus peut être équipé avec de tiroirs ou de portes abatantes, et se prête à l'ameublement des environnements domestiques ou professionnels.

Un sistema modular de librerías, enteramente de aluminio extruido, basado en la composición libre del cuadrado y del rectángulo como figuras modulares. Un concepto geométrico riguroso que permite la definición de libreras de varias dimensiones con un fuerte valor escenográfico. Perfectamente bifacial, puede equiparse con cajones o puertas abatibles, Opus se presta para equipar con personalidad el hogar o entornos profesionales.

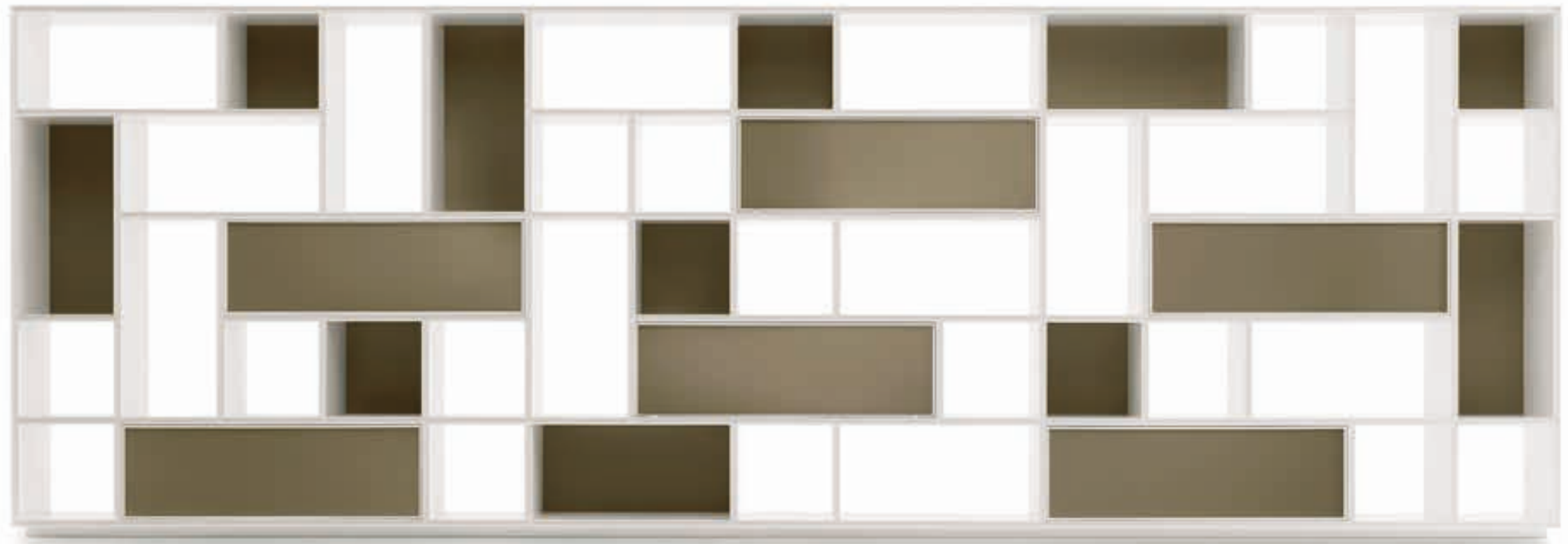

**Modularità**  
Modular structure

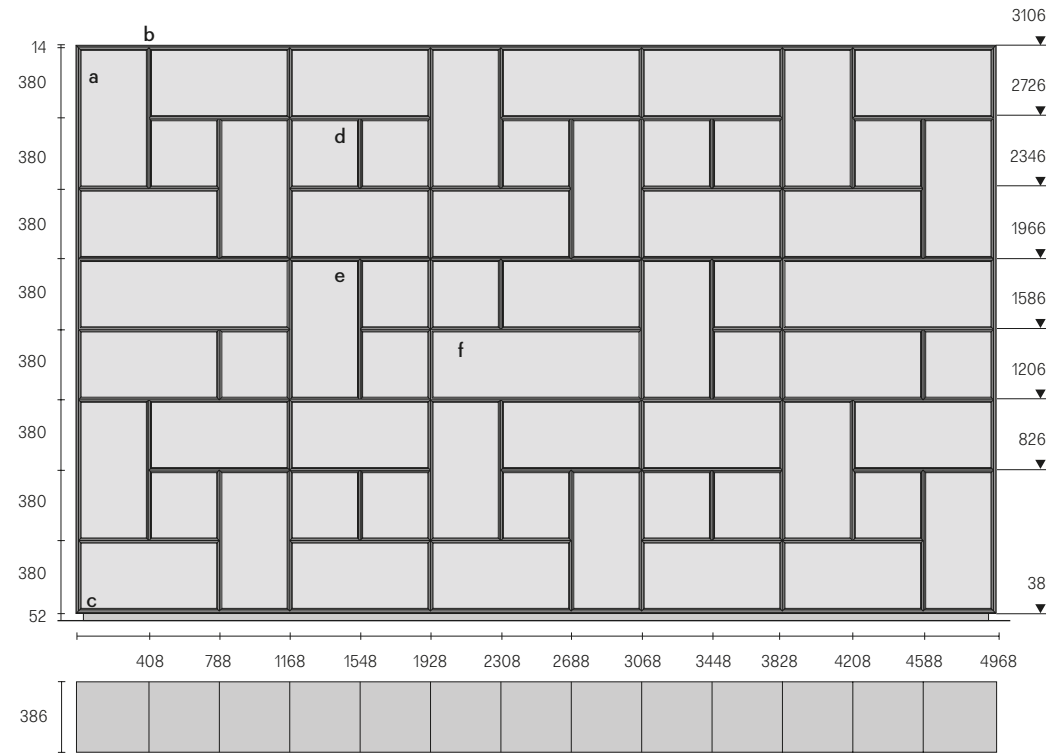

- a. Spalla laterale / Side panel
- b. Top / Top
- c. Basamento / Floor base
- d. Modulo 380 x 380  
Module 380 x 380
- e. Modulo 380 x 760  
Module 380 x 760
- f. Modulo 380 x 1140  
Module 380 x 1140

**Descrizione tecnica**  
Technical description

Opus è un sistema libreria componibile, interamente realizzato in alluminio estruso, basato sulla libera composizione del quadrato e del rettangolo come elementi modulari. Una semplicità concettuale che assicura al progetto un'eccezionale versatilità, con la possibilità di realizzare composizioni anche di ampie dimensioni, in assoluta sicurezza. Grazie alla bifaccialità, Opus è in grado di formulare molteplici soluzioni per la definizione architettonica degli ambienti.

Opus is a modular shelving system entirely made in extruded aluminum, based on the free composition of squares and rectangles as modular elements. A conceptual simplicity that ensures exceptional versatility when designing, with the possibility of carrying out even very big compositions in complete safety. Thanks to its two-sided feature, Opus can provide multiple solutions for the architectural definition of environments.

Opus ist ein modulares Regalssystem, komplett fließgeschweißtes Aluminium, mit der freien Kombination des Quadrats und des Rechtecks als System-Elemente. Die Einfachheit dieses Konzepts bietet eine außerordentliche Planungsvielseitigkeit sowie die Möglichkeit auch sehr große Anlagen in absoluter Sicherheit bauen zu können. Die beidseitige Verwendung ermöglicht freie Erweiterungsmöglichkeiten, um Architektur der Räume definieren zu können.

Opus est un système de bibliothèque à éléments, entièrement réalisé par extrusion d'aluminium, basé sur la libre composition du carré et du rectangle comme éléments composables. Une simplicité de concept qui assure au projet un caractère universel exceptionnel avec la possibilité de réaliser des compositions, même de grandes dimensions, en totale sûreté. Opus, parfaitement bifaciale, permet de proposer plusieurs solutions pour la définition architecturale des ambiances.

Opus es un sistema librería componible, realizado por completo en aluminio extruido, basado sobre la libre composición del cuadrado y del rectángulo como elementos modulares. Una simplicidad conceptual que asegura al proyecto una excepcional versatilidad, con la posibilidad de realizar composiciones también de amplias dimensiones, en absoluta seguridad. Gracias a la bifrontalidad, Opus es capaz de formular múltiples soluciones para la definición arquitectónica de los ambientes.

**Componenti**  
Components



1.



2.

1. Cassettiera con frontale in vetro laccato. I cassetti sono interamente in alluminio, con guide ad estrazione totale e sistema di autorientro silenzioso. / Drawer unit with lacquered glass front. The drawers are made entirely of aluminium, with fully extractable runners and a silent automatic recall device.
2. Le vetrine con anta a ribalta sono in vetro temperato con telaio in alluminio e sono dotate di esclusive cerniere invisibili. / The glass cabinets with flap doors are in tempered glass with aluminium frame and they are equipped with exclusive and invisible hinges.

Modulo a giorno in alluminio  
Open module in aluminium

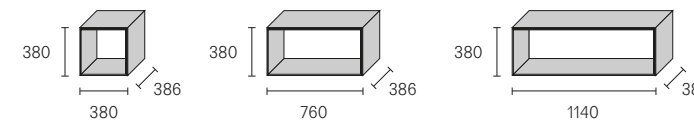

Modulo con cassetti e schienale in vetro  
Module with drawers and glass back

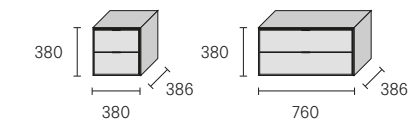

Tovaglietta opzionale in similpelle per fondo cassetti  
Optional synthetic leather mat for drawer bottom



Modulo a giorno con schienale in vetro  
Open module with glass back

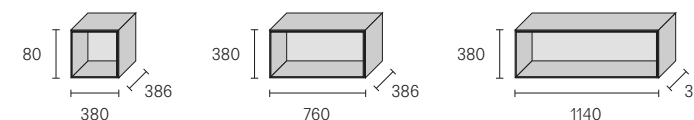

Modulo con anta a ribalta e schienale in vetro  
Module with flap door and glass back

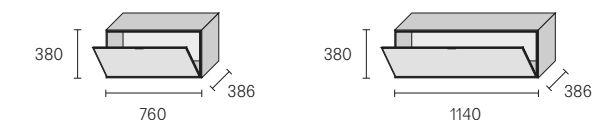

Top in alluminio  
Top in aluminium

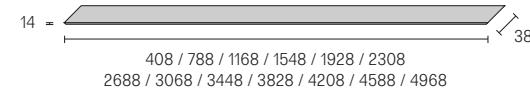

Basamento in alluminio  
Base in aluminium

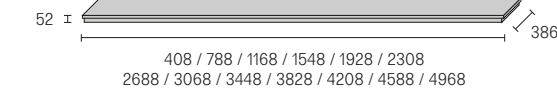

Spalla laterale in alluminio  
Side panels in aluminium

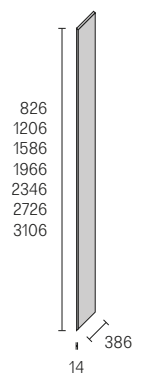



Design Giuseppe Bavuso

## Wind

Wind is the archetype of the bookcase in the new interpretation by Rimadesio: a modular system combining aesthetic lightness and technological innovation. The focus of the project, entirely in aluminium, is represented by the union between extruded shelves and die-casting uprights, in central and terminal versions. Vertical modularity of Wind is obtained by the connection of nylon fibre joints inserted into the uprights which grant the maximum stability. Closing element of each composition is the laminated lacquered mdf top, covered by a double aluminium plate.

Wind è l'archetipo della libreria nella nuova interpretazione Rimadesio: un sistema modulare che coniuga leggerezza estetica e innovazione tecnologica. Il fulcro del progetto, interamente in alluminio, è rappresentato dall'unione fra ripiani estrusi e montanti in pressofusione, in versione centrale e terminale. La componibilità verticale di Wind avviene tramite giunti di collegamento in nylon fibra che si innestano nei montanti e garantiscono la massima stabilità. Elemento terminale di ogni composizione è il top laccato e stratificato in mdf rivestito da una doppia lastra di alluminio.

Wind steht für den neuen Archetyp der Interpretation von Rimadesio: ein modulares System, welches ästhetische Leichtigkeit und technologische Innovation miteinander vereint. Im Mittelpunkt des Projekts steht die Einzigartigkeit der Verbindung aus stranggepressten Profilen der Fachböden und dem aus Aluminiumdruck gegossenen Pfosten. Sowohl in der vertikalen als auch der horizontalen. Die vertikale Komposition von Wind erfolgt durch Verbindungsstücke aus Nylonfaser direkt in den Pfosten, die auch für maximale Stabilität steht. Jede Komposition schließt mit einem aluminiumbezogenem lackiertem Mdf-Sperrholz ab.

Wind est l'archétype de la bibliothèque dans la nouvelle interprétation de Rimadesio: un système modulaire qui combine légèreté esthétique et innovation technologique. Caractéristique du projet, entièrement en aluminium, il est représenté par l'union des étagères extrudées et des montants en moulage d'aluminium en version centrale ou terminale. La modularité verticale de Wind s'effectue par les jonctions de connexion en fibre de nylon qui s'intègrent dans les montants, en assurant une stabilité maximale. L'élément final de chaque composition est le dessus, laqué et stratifié en mdf, revêtu par un double placage d'aluminium.

Wind es el arquetipo de la librería en la nueva interpretación Rimadesio: un sistema modular que combina ligereza estética e innovación tecnológica. El enfoque del proyecto, por completo en aluminio, es representado por la unión entre los estantes extruidos y los montantes en inyección, en versión central y terminal. La modularidad vertical de Wind se lleva a cabo a través de articulaciones de conexión en fibra de nylon que se acoplan en los montantes y garantizan la máxima estabilidad. Elemento terminal de cada composición es el top lacado estratificado en mdf chapado por una hoja doble de aluminio.

Struttura Structure: 16 bianco latte  
Piedino regolabile in nickel satinato  
Adjustable foot in satin nickel





Libreria freestanding *Freestanding bookcase*  
Struttura *Structure*: 16 bianco latte  
Schienale in vetro  
*Glass back panel*: 01 acidato  
W 4020 H 1202 D 400

Wind ➤

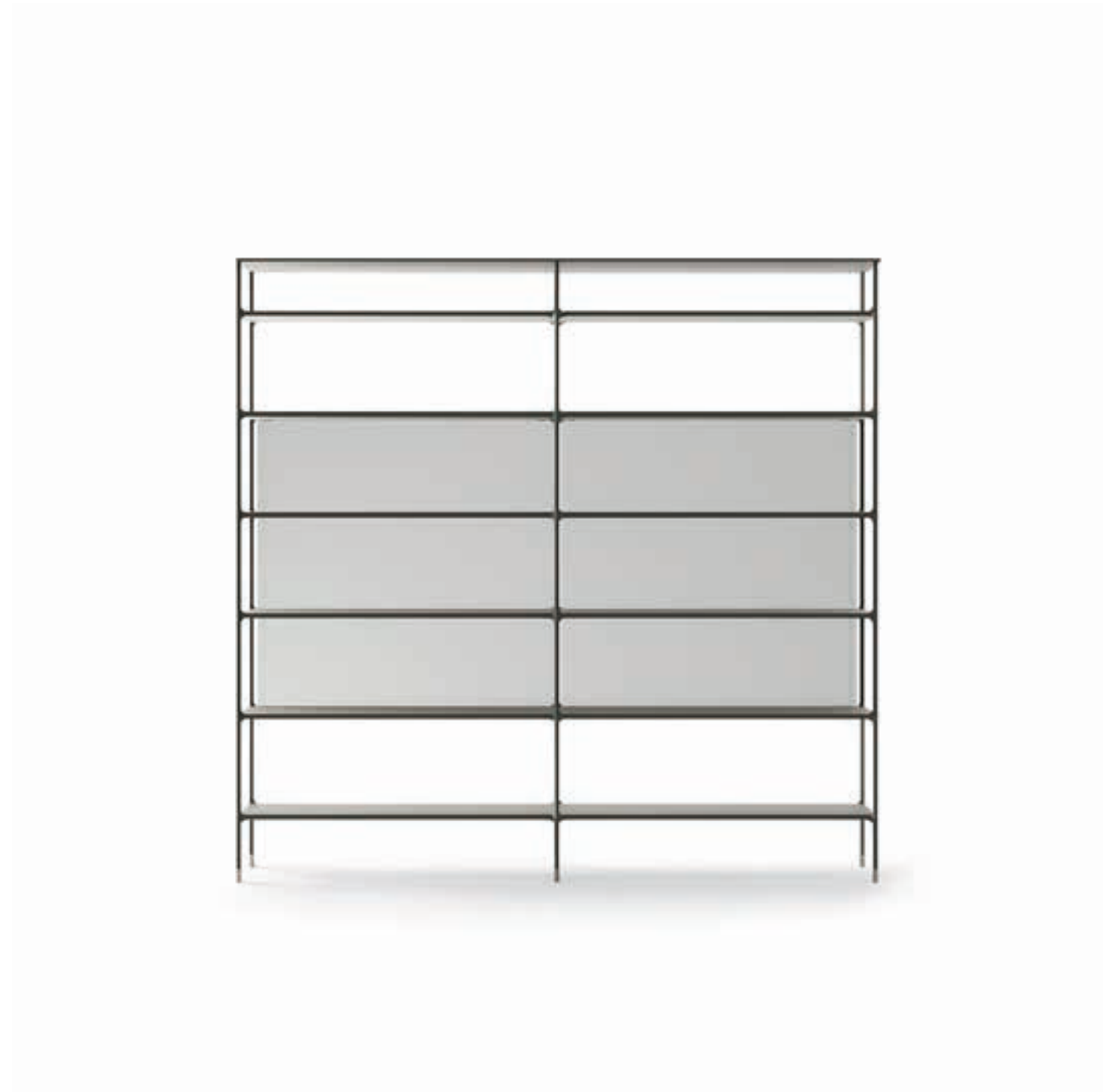

Libreria freestanding *Freestanding bookcase*  
Struttura *Structure*: 13 nero  
Schienale in vetro  
*Glass back panel*: 63 grigio trasparente  
W 2020 H 2342 D 400

Day collection

Wind ➤



**Modularità**  
**Modular structure**

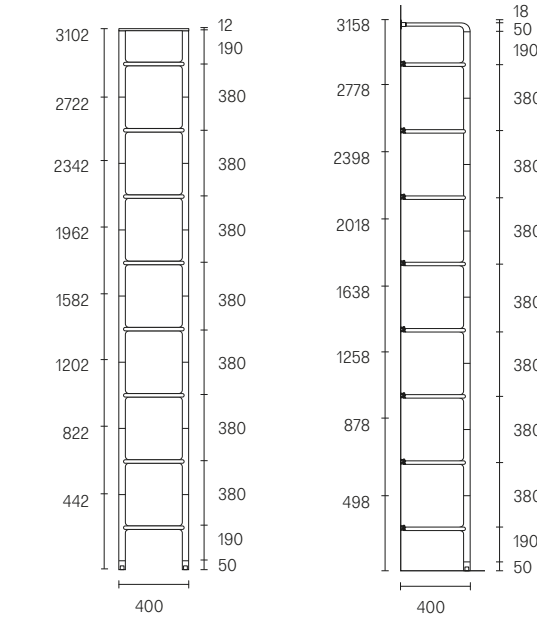
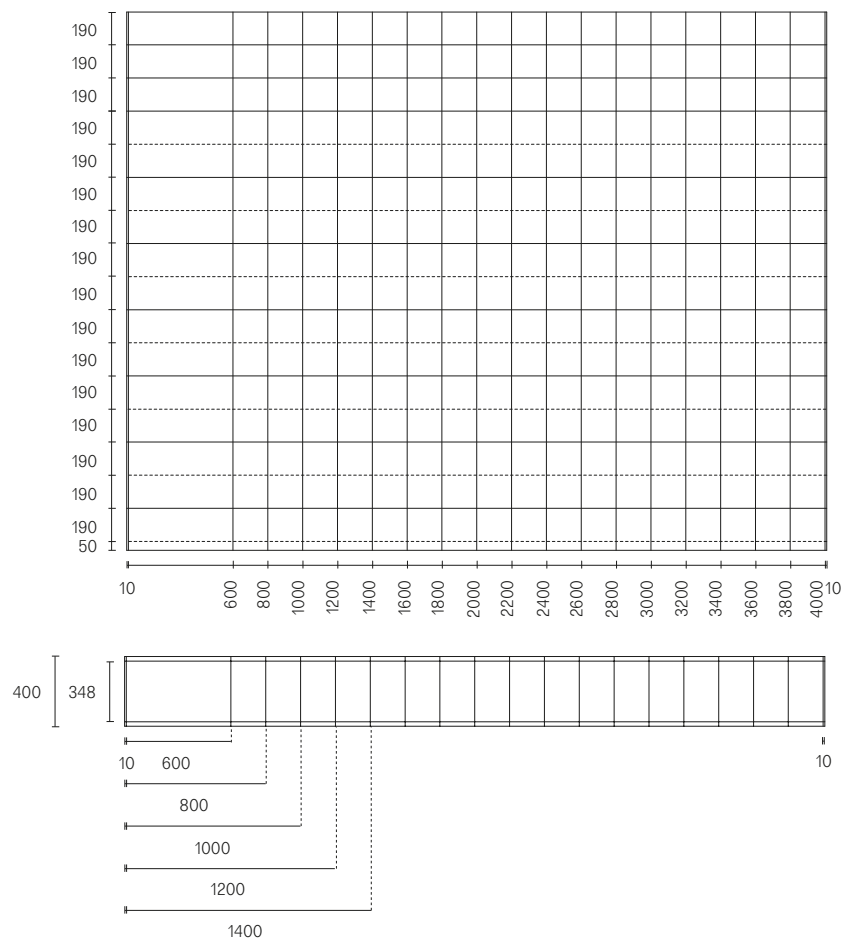

Composizione freestanding  
Freestanding composition

Composizione a parete  
Wall composition

**Descrizione tecnica**  
**Technical description**

Prevista in 5 larghezze e 7 altezze, la libreria Wind è disponibile nelle finiture alluminio brown, nero, bianco latte, nei 34 colori laccati della gamma Ecolorsystem, oltre alle 5 finiture con effetto graffiato. Tutte le finiture sono realizzate con vernici idrosolubili di ultima generazione.

Wind bookcase is available in 5 widths and 7 heights, in brown, black, bianco latte, 34 Ecolorsystem lacquered colours and 5 with scraped effect finishes. All finishes are obtained from water paints of latest generation.

Wind ist verfügbar mit 5 Breiten, 7 Höhen und Alu Struktur Ausführung brown, schwarz, bianco latte, 34 lackierte Farbe von Ecolorsystemkollektion sowie 5 geschliffene Oberflächen. Alle die Ausführungen sind Absolut oekologische Farben, und sind die modernsten verfügbaren Lackierungen.

La bibliothèque Wind est disponible en 5 largeurs et 7 hauteurs dans les finitions en aluminium brown, nero, bianco latte, laquée dans les 34 couleurs de la gamme Ecolorsystem, en plus de cinq effet rayé. Toutes les finitions sont réalisées avec la dernière génération de peintures hydrosolubles.

Prevista en 5 anchuras y 7 alturas, la librería Wind es disponible en los acabados aluminio brown, negro, bianco latte, en los 34 colores lacados de la gama Ecolorsystem, además de los 5 acabados con efecto rayado. Todos los acabados están realizados con pinturas hidrosolubles de última generación.

**Componenti**  
**Components**



1.



2.



3.



4.

1. Contenitore a due cassetti: fianchi, schienale e frontale cassetti in vetro laccato. Cassetti in alluminio con apertura push e guide ad estrazione totale. / Two drawer-unit: Sides, back panel and front in lacquered glass. Drawers in glossy aluminium with push and pull opening and totally extractable runners.
2. Contenitore bar con anta a ribalta, schienale interno in specchio grigio e ripiano in vetro trasparente extra-chiaro. / Bar unit with flap door, internal back panel in grey mirror and shelf in transparent extraclear glass.
3. Dettaglio del raccordo fra ripiano in alluminio estruso e montante in alluminio pressofuso, in versione centrale e terminale. / Detail of the junction between the extruded aluminium profile and the die-casting aluminium upright, terminal and central version.
4. Lo schienale in vetro temperato è dotato di un esclusivo sistema d'aggancio, ed è disponibile in un'ampia varietà di finiture. / The backpanel in tempered glass is equipped with an exclusive hanging system, and it is available in a wide range of finishings.

Top in mdf laccato e stratificato, rivestito da una doppia lastra di alluminio / Laminated lacquered mdf top, covered by a double aluminium plate

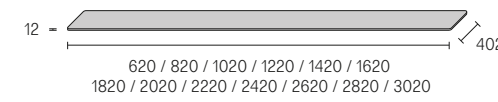

Ripiano in alluminio con profili estrusi di chiusura  
Aluminium shelf with extruded closing profiles

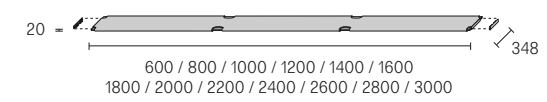

Schienali in vetro temperato  
Backs in tempered glass

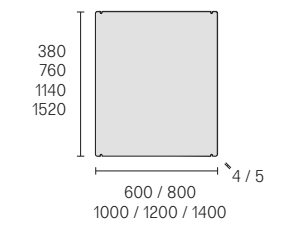

Montanti terminali e centrali in pressofusione di alluminio  
Terminal and central uprights in die-casting aluminium



Montante per vani a doppia altezza / Upright for double-height openings



Supporti per ripiano a parete e staffa superiore a parete  
Wall shelf brackets and upper wall bracket

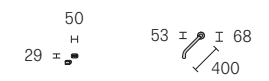

Piedino regolabile  
Adjustable foot



Modulo a giorno in acciaio laccato / Open module in lacquered steel

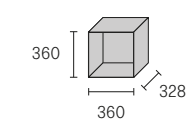

Cassettiera con 2 cassetti push  
Drawer unit with 2 push drawers

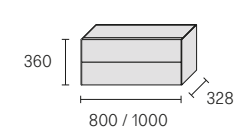

Tovaglietta opzionale in similpelle per fondo cassetti  
Optional synthetic leather mat for drawer bottom

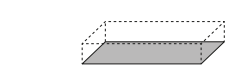

Contenitore con anta a ribalta  
Flap door cabinet

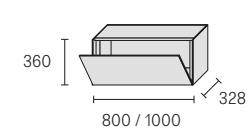

Contenitore bar con anta a ribalta / Bar cabinet with flap door

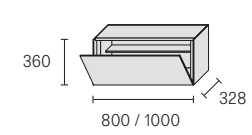

Porta decoder per vano TV  
Decoder support for TV compartment

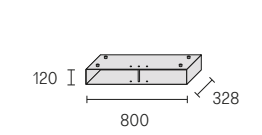





Design Giuseppe Bavuso

## Alambra

With Alambra, Rimadesio gives a contemporary reinterpretation of classic furniture like sideboards, glass cabinets and drawer units. A collection characterized by the particular structure in aluminum, by exclusive design details, by the mechanisms of movement and by shelves equipped with integrated led lighting system. A proposal available in different sizes and with different technical internal equipment.

Con Alambra, Rimadesio propone una reinterpretazione in chiave contemporanea di tipologie classiche dell'arredo come madie, vetrine e cassetiere. Una collezione caratterizzata dalla particolare struttura in alluminio, dal disegno esclusivo dei dettagli, dai meccanismi di movimento e dotata di illuminazione a led integrata nei ripiani. Una proposta articolata in varie dimensioni e dotata di attrezzature tecniche differenziate.

Mit Alambra bietet Rimadesio eine gemäßige Neuinterpretation den klassischen Möbeltypen wie Sideboard, Vitrine und Schubladen Elementen an. Eine Kollektion von der besonderer Struktur aus Aluminum charakterisiert, exklusive Design-Details, Mechanismen der Bewegung und Led-Beleuchtung integriert bei Fachböden. Einer artikulierter Vorschlag in verschiedenen Massen und mit differenzierten technischen Ausrüstungen.

Avec Alambra, Rimadesio propose une réinterprétation contemporaine de meubles comme les bahuts, les vitrines et les blocs tiroirs. Une collection caractérisée par une particulière structure en aluminium, par des détails exclusifs de design, par mécanismes de mouvement et équipée de système d'éclairage à led intégré dans les étagères. Une proposition disponible en différentes dimensions et avec équipements différents.

Con Alambra, Rimadesio ofrece una reinterpretación contemporánea de tipologías clásicas de mobiliario como aparadores, vitrinas y cajoneras. Una colección que se caracteriza por la estructura particular en aluminio, de diseño exclusivo de los detalles, de los mecanismos de movimiento y dotata de iluminación por leds integrada en los estantes. Una propuesta que se articula en varios tamaños y con equipo técnico diferentes.

Struttura Structure: 304 platino  
 Ante, fianchi e schienale  
 Doors, side panels and back panel: 67 riflettente chiaro  
 Top Top: 137 platino opaco  
 Ripiano Shelf: 63 grigio trasparente  
 Cassetti e basamento Drawers and floor base: 15 noce  
 W 1008 H 1516 D 500





Mobile bar *Bar cabinet*  
 Struttura *Structure*: 304 platino  
 Ante, fianchi, e ripiano  
*Doors, sides and shelf*: 63 grigio trasparente  
 Schienale *Back panel*: 68 specchio grigio  
 Top *Top*: 137 platino opaco  
 W 1308 H 1659 D 500

Architettura e arredo si integrano con armonia, suggerendo spazi domestici essenziali e rigorosi. Questa è la filosofia alla base del progetto Alambra, caratterizzato dal particolare disegno delle ante, comune al sistema di porte scorrevoli Stripe e alla porta battente e scorrevole Even. Il design di Alambra riduce al minimo gli spessori strutturali in alluminio, lasciando che il vetro trasparente e il sistema di illuminazione a led integrato nei ripiani valorizzi al massimo gli oggetti esposti.

Architecture and interior design are harmoniously integrated, thus suggesting essential and rigorous domestic spaces. This is the philosophy behind the Alambra project, characterized by its particular design of the doors, the same of the sliding panel system Stripe and the swing and sliding door Even. The Alambra design minimizes the aluminum structural thickness, thus maximizing the clear glass and the led lighting system, which is built into the shelves.

Architektur und Möbeln mit Harmonie sich einbinden, und hindeuten wesentlichere und strengere Wohnräume. Das ist die Philosophie hinter dem Projekt Alambra, gekennzeichnet von besonderen Design der Türen, wie bei Schiebetüren System Stripe und Even Tür. Das Design Alambra reduziert die Strukturstärken des Aluminiums auf ein Minimum. Das transparente Glas und die Led Beleuchtung in den Böden bringen die ausgestellten Gegenstände voll zur Geltung.

Architecture et décoration d'intérieurs sont intégrés harmonieusement et créent espaces domestiques essentiels et rigoureux. C'est bien la philosophie du projet Alambra, caractérisé par le dessin des portes, le même des panneaux coulissants Stripe et de la porte battante ou à galandage Even. Le design de Alambra minimise l'épaisseur de la structure aluminium, laissant que le verre transparent et le système d'éclairage à led intégré dans les étagères mettent en valeur les objets exposés.

Arquitectura y mobiliario se mezclan armoniosamente, sugiriendo espacios domésticos esenciales y rigurosos. Esta es la filosofía detrás del proyecto Alambra, que se caracteriza por el diseño particular de las puertas, común al sistema de paneles correderos Stripe y a la puerta batiente y corredera Even. El design de Alambra minimiza el grosor de la estructura de aluminio, dejando que el vidrio transparente y el sistema de iluminación por led integrado en los estantes maximice los objetos expuestos.





Struttura *Structure*: 13 nero  
Ante *Doors*: 63 trasparente grigio  
Fianchi e schienali  
*Side and back panels*: 64 riflettente grigio  
Top *Top*: 102 nero opaco

Alambra ↗



Struttura *Structure*: 14 brown  
Vetro *Glass*: 03 acidato grigio  
Top *Top*: 99 caffè opaco  
Cassetti *Drawers*: 19 rovere termotrattato  
Ripiano interno *Internal shelf*: 63 trasparente grigio  
W 2616 H 833 D 500

Day collection

Alambra ↗





Mobile espositore centrostanza *Middle room display unit*  
 Struttura e base *Structure and base*: 303 bronzo  
 Vetro *Glass*: 67 riflettente chiaro  
 Cassetti *Drawers*: 15 noce  
 Interno cassetti *Drawer internal lining*: 153 similpelle castoro  
 Schienale interno *Internal back*: 68 specchio grigio  
 Ripiani in vetro *Glass shelves*: 63 grigio trasparente  
 W 2016 H 833 D 939







La vetrina pensile è dotata di un esclusivo meccanismo invisibile per l'apertura dell'anta ribalta, specificatamente progettato per questa raffinata versione a parete, frutto della ricerca tecnologica Rimadesio.  
L'illuminazione led di ultima generazione è incassata nei profili orizzontali in alluminio.

The suspended display case is equipped with an exclusive invisible mechanism for the opening of the flap door, specifically designed for this refined wall version, the result of Rimadesio's technological research.  
The led lighting system of latest generation is embedded in the horizontal aluminum profiles.

Die Hängevitrine ist mit einem exklusiven unsichtbaren Mechanismus für das Öffnen der Klapptür ausgestattet. Letzterer ist das Ergebnis der technologischen Forschung Rimadesios, das speziell für diese raffinierte Wandversion ausgelegt ist.  
Die Led-Beleuchtung der neuesten Generation ist in die horizontalen Aluminiumprofile eingebettet.

La vitrine suspendue est équipée d'un exclusif mécanisme invisible pour l'ouverture de la porte abattante, spécialement conçu pour cette version murale raffinée, comme résultat de la recherche technologique Rimadesio.  
L'éclairage led de dernière génération est intégré dans les profilés horizontaux en aluminium.

La vitrina colgante está equipada de un exclusivo mecanismo invisible para la apertura de la puerta abatible, específicamente diseñado para esta versión refinada a pared, resultado de la investigación tecnológica de Rimadesio. La iluminación led de última generación está integrada en los perfiles horizontales en aluminio.





Libreria Bookcase  
 Struttura Structure: 14 brown  
 Top e basamento Top and floor base: 75 amaranto  
 Schienale e cassetti in vetro  
 Glass back panel and drawers: 75 amaranto lucido  
 Ripiani e fianchi Shelves and sides: 63 grigio trasparente  
 Ripiano strutturale e interno cassetti  
 Structural shelf and internal drawers: 153 similpelle castoro  
 W 1948 H 1900 D 400

## Modularità Modular structure

Versione con basamento  
Version with floor base

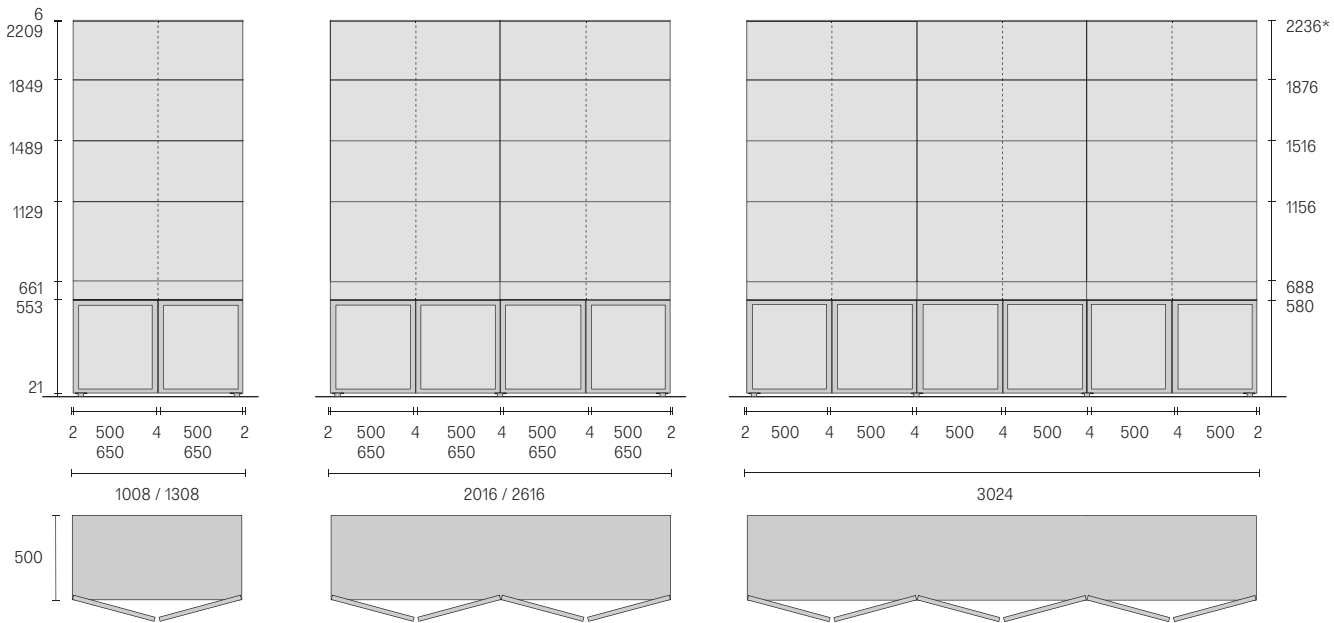

Versione con piedini  
Version with feet

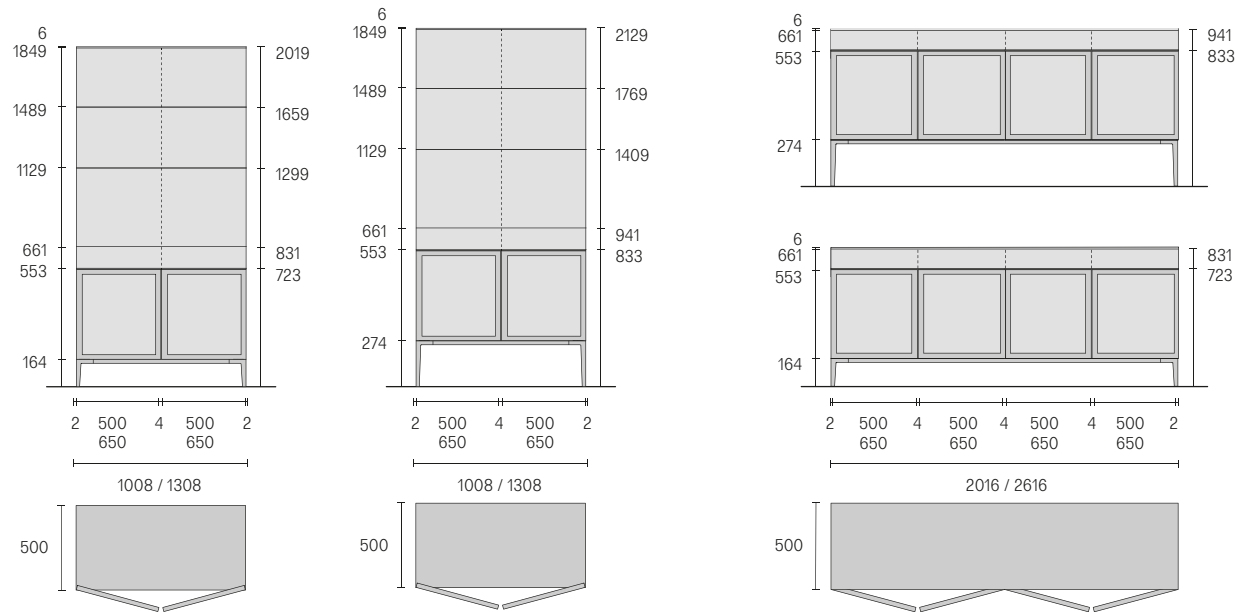

## Descrizione tecnica Technical description

Alambra è un sistema bifacciale in alluminio e vetro con top e basamento in legno disponibile in tre essenze: noce, rovere nero e rovere termotrattato. Il top, in alternativa, può essere realizzato in vetro trasparente. La struttura è disponibile in alluminio brown, nero e platino. Ante, spalle, schienali e ripiani sono realizzati in vetro temperato.

Alambra is a double sided system in aluminum and glass with wooden top and base, available in three finishes: walnut, black oak and heat treated oak. The top can be in transparent glass, as an option. The structure is available in brown, black and platino aluminum. Doors, side panels, back panels and shelves are made of tempered glass.

Alambra ist ein freistehendes System aus Aluminium und Glas mit Holzabdeckplatte und Holzbasisboden erhältlich in 3 Ausführungen: Nussbaum, Eiche Schwarz und termobehandelte Eiche. Die Abdeckplatte kann alternativ aus transparentem Glas bestehen. Die Struktur ist verfügbar in Aluminium Brown, Aluminium Schwarz und Aluminium Platino. Türen, Seitenteile, Rückwänden und Böden sind in temperiertem Glas.

Alambra est un système bifacé en aluminium et verre avec top et base en bois disponible en noyer, chêne noir et chêne thermo-traité. Le plateau peut également être en verre transparent. La structure est disponible en aluminium brown, noir et platino. Portes, côtés, dos et étagères sont réalisées en verre trempé.

Alambra es un sistema bifacial en aluminio y cristal con el sobre y la base en madera disponible en tres acabados: nogal, roble negro y roble termotrattado. Como alternativa, el sobre puede ser realizado en vidrio transparente. La estructura está disponible en aluminio brown, negro y platino. Las puertas, los laterales, la trasera y los estantes están realizados en cristal templado.

## Componenti Components

Spalla laterale in vetro temperato riflettente, trasparente, acidato e laccato opaco o lucido con struttura in alluminio  
Side panel in reflective, transparent, etched and mat or glossy lacquered tempered glass with aluminum frame

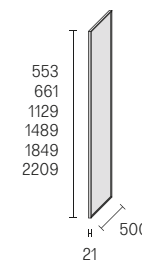

Schienale in vetro riflettente, trasparente, acidato, specchio e laccato opaco o lucido e montante centrale in estruso d'alluminio / Back in reflective, transparent, etched, mirror and mat or glossy lacquered glass and central upright in extruded aluminum

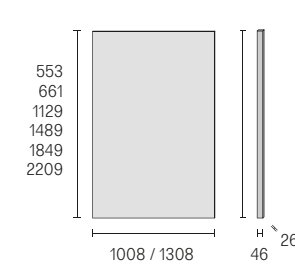

Anta in vetro temperato riflettente, trasparente, acidato e laccato opaco o lucido con struttura in alluminio, versione con e senza traversini. Serratura opzionale  
Door in reflective, transparent, etched and mat or glossy lacquered tempered glass with aluminum frame, available with or without crosspieces. Optional locking

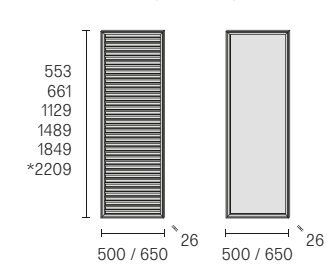

Top trasparente in vetro temperato con tiranti strutturali in alluminio e top in legno e vetro temperato laccato opaco. Illuminazione led anteriore e posteriore opzionali / Transparent top in tempered glass with structural aluminum bars and top in wood and tempered lacquered glass. Optional front and rear led lighting

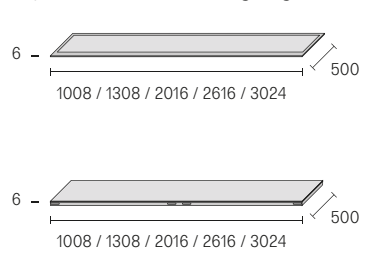

Ripiano interno in vetro temperato trasparente, acidato e laccato opaco o lucido, con ring in alluminio. Illuminazione a led opzionale / Internal shelf in transparent, etched and mat or glossy lacquered tempered glass, with aluminum ring. Optional led lighting system

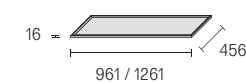

Cassetto sospeso in legno con lavorazione "a coda di rondine" e fondo rivestito in similpelle. Telaio di supporto in acciaio laccato / Wooden suspended drawer with dove-tie assembling and internal lining in synthetic leather. Supporting frame in lacquered steel

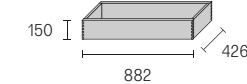

Cassetto sottotop in legno con fondo e divisori rivestiti in similpelle, telaio perimetrale di supporto in alluminio  
Wooden undertop drawer with bottom lining and dividers in synthetic leather, supporting surround frame in aluminum

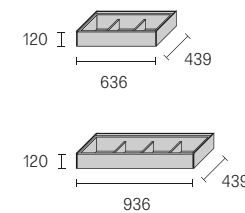

Cassettiere in legno in appoggio o sospese / Floor or suspended wooden drawer units

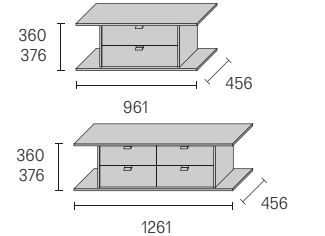

Basamento in legno con puntali regolabili o con piedini in alluminio. Wooden base with adjustable tips or with aluminum legs.

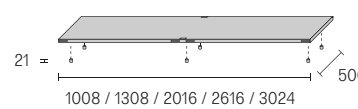

Illuminazione a led per top in legno, ripiano in vetro e cassetteria sospesa. Led lighting system for wooden top, glass shelf and suspended drawer units

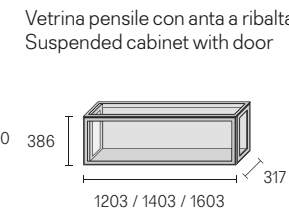
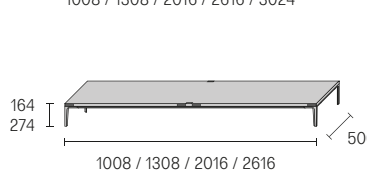
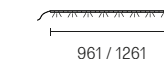

Vetrina pensile con anta battente  
Suspended cabinet with hinged door

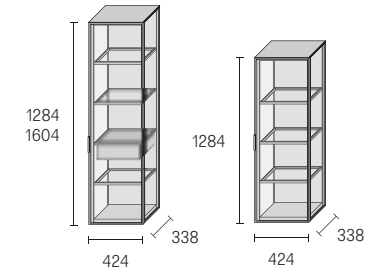

Monetiere

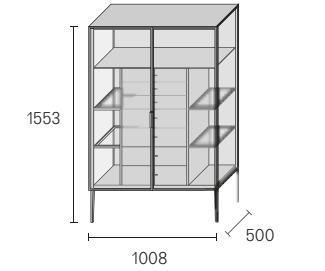

Libreria  
Bookcase

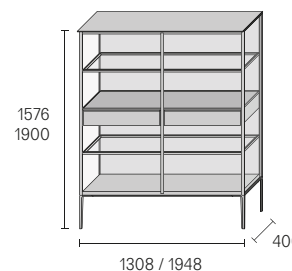

Mobile bar  
Bar cabinet

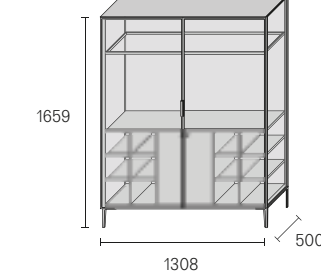

Isola: mobile espositore centro stanza con top trasparente  
Isola: middle room display unit with transparent top

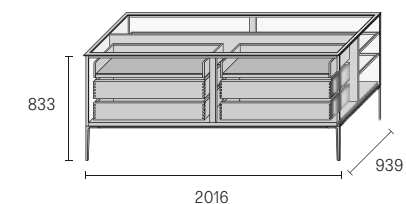

Madia espositore con top trasparente e cassetti interni  
Case sideboard with transparent top and internal drawers

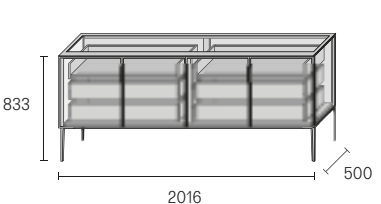



Design Giuseppe Bavuso

## Self

A modular system that allows to create single and double-sided sideboards, bedside tables, drawer units and suspended wall compositions. A versatile design, based on horizontal modularity, with drawers and hinged doors entirely covered in lacquered glass, and open compartments in walnut veneer or lacquered in Ecoloursystem colors.

Un sistema componibile che permette di creare medie mono e bifacciali, comodini, settimanali e composizioni sospese a parete. Un progetto versatile, basato su una modularità orizzontale, con elementi contenitori a cassetti e con anta battente, interamente rivestiti in vetro laccato, e da vani a giorno in essenza di noce o laccati nei colori Ecoloursystem.

Ein modulares System, mit dem man ein- und zweiseitige Schränke, Nachttische, Wochenzeitungen und Wandbehang-Kompositionen erstellen kann. Ein vielseitiges Design, basierend auf horizontaler Modularität, mit Schubladeneinheiten und Drehtüren, das erhältlich ist aus komplett lackiertem Glas und offenen Fächern aus Nussbaumholz oder lackiert mit Ecolor-system Farben.

Un système modulaire qui permet de créer des bahuts à une ou deux faces, des chevets, des semanaires et des compositions suspendues. Un design polyvalent, basé sur la modularité horizontale, avec des tiroirs et des portes battantes, entièrement recouvert de verre laqué, et des compartiments ouverts en noyer ou laqués dans les couleurs Ecoloursystem.

Un sistema modular que permite realizar aparadores mono o bifaciales, mesitas de noche, semanales y composiciones colgantes a pared. Un proyecto versátil, basado sobre una modularidad horizontal, con elementos contenedores con cajones y puertas abatibles, completamente cubiertos en cristal lacado, y módulos abiertos en madera de nogal o lacados en los colores Ecolor-system.







Comodino *Bedside unit*  
 Struttura *Structure*: 69 palladio  
 Vetro *Glass*: 45 avorio lucido  
 W 640 H 320 D 485

Settimanale *Drawer unit*  
 Struttura *Structure*: 303 bronzo  
 Vetro *Glass*: 303 bronzo lucido  
 W 640 H 1280 D 485

Comò *Dresser*  
 Struttura *Structure*: 303 bronzo  
 Vetro *Glass*: 57 tortora lucido  
 W 1920 H 480 D 485



Struttura *Structure*: 30 alluminio  
 Vetro *Glass*: 108 bianco latte opaco  
 W 3850 H 359 D 485





Design Giuseppe Bavuso

## Self bold

A simple and minimal design, perfect and pure lines, continuous surfaces: Self bold is the suspended modular system becoming a sideboard, expressing Rimadesio essential and contemporary design. Pure geometry and possibility to be combined with other collections, allow Self bold to be positioned with elegance and personality in every context. The top is one of the main characteristic of the collection, both when is more refined as thick marble, and in the glass version where a thin profile is marking the outline.

Un disegno pulito ed essenziale, linee assolute e nitide, superfici pure e continue: Self bold è il sistema d'arredo sospeso declinato anche nella configurazione a madia, che esprime l'essenzialità e la contemporaneità di Rimadesio. Geometrie assolute e capacità di dialogare con altre collezioni permettono a Self bold di inserirsi con eleganza e personalità nello spazio. Il top è uno dei tratti distintivi della collezione, sia quando si manifesta nella ricercata matericità dei marmi di forte spessore, sia quando nella versione in vetro viene definito da un sottile profilo che ne delinea l'ingombro.

Saubere und wesentliche Formen, klare und absolute Linien, reine und laufende Oberflächen: Self Bold als abgehangenes System oder Einzelmöbel entspricht der Wesentlichkeit und Modernität von Rimadesio. Dank der absoluten Geometrie und der Möglichkeit des Dialogs mit anderen Kollektionen von Rimadesio, kann sich Self Bold mit Eleganz und Personalität in den Raum integrieren. Charakteristisches Merkmal der Kollektion ist die Abdeckplatte, sowohl aus dickem Marmor als auch aus Glas mit feinerer Staercke.

Un design simple et pure, lignes absolues et nettes, surfaces harmonieuses et uniformes: Self bold est le système de meubles suspendus, et bahuts aussi, qui exprime la simplicité et modernité de Rimadesio. La géométrie absolue et la capacité de s'accoupler aux autres collections, permettent à Self bold de s'adapter avec élégance et personnalité à tous les espaces. Le top est un trait distinctif de la collection, aussi bien quand il est caractérisé par la matérialité recherchée des marbres épais, lorsque qu'il est défini, dans la version en verre, par son profil très fin qui en souligne la forme.

Un diseño limpio y esencial, líneas absolutas y nítidas, superficies puras y continuas: Self bold es el sistema de mobiliario colgante declinado también en configuración a aparador, que expresa la esencialidad y la contemporaneidad de Rimadesio. Geometrías absolutas y capacidad de dialogar con otras colecciones permiten a Self bold de encajar con elegancia y personalidad en el espacio. El top es uno de las señas de identidad de la colección, tanto cuando se manifiesta en la búsqueda de la materialidad del mármol de gran espesor, como cuando la versión del vidrio se define por un perfil fino que delinea la forma.

Struttura *Structure*: 300 rame  
 Fianchi e profilo posteriore  
*Sides and rear profile*: 300 rame  
 Top in vetro *Glass top*: 133 rame opaco  
*Ante Doors*: 81 riflettente bronzo  
 Interno vetrina *Internal cabinet*: 15 noce  
*Ripiani Shelves*: 63 grigio trasparente  
 Schienale interno *Internal back panel*: 89 nero reflex









Un segno grafico, un profilo sottile che si fa volume, che definisce il perimetro di una forma, sottolinea una superficie, identifica uno spazio. Un gioco di piani ortogonali, di dettagli perfettamente coplanari, di materiali come il vetro, il marmo e il metallo che si relazionano attraverso spessori misurati che danno voce a un progetto rigoroso, equilibrato, coerente in tutti i suoi aspetti.

A graphic sign, a thin profile becoming a volume and defining the shape perimeter, highlighting the surface and identifying the space. A design based on different orthogonal planes, perfectly coplanar details, materials such as glass, marbles, metal that are combined through reduced thickness and create a rigorous, balanced and coherent project.

Ein grafisches Zeichen, ein feines Profil, welches sich Raum verschafft, das den Umfang einer Form definiert, unterstreicht eine Oberfläche und identifiziert einen Raum. Ein Spiel von rechtwinkligen Ebenen, von perfekten koplanaren Details, von Materialien wie Glas, Marmor und Metall, welche sich durch genaue Materialstärken miteinander kombinieren gibt einem rigorosem, und abgestimmten Projekt Ausdruck.

Un signe graphique, un profil mince qui rend le volume, qui définit le périmètre d'une forme, souligne une surface identifie un espace. Un jeu de plans orthogonaux, de détails parfaitement coplanaires, de matériaux tels que le verre, le marbre et le métal qui sont liés par des épaisseurs mesurées qui expriment une conception rigoureuse, équilibrée, cohérente dans tous ses aspects.

Un signo gráfico, un perfil fino que hace volumen, que define el perímetro de una forma, subraya una superficie, identifica un espacio. Un juego de planos ortogonales, los detalles perfectamente coplanares, de materiales tales como vidrio, el mármol y el metal que se relacionan a través de espesores medidos que dan voz a un diseño riguroso, equilibrado, coherente en todos sus aspectos.







Design Giuseppe Bavuso

## Self up

**Self Up:** the freestanding compositions characterized by the aluminium feet. A wide variety of solutions, defined by an aesthetics inspired to the maximum lightness. The feet, in the same colour of the profiles, are provided in the following finishings: aluminium, brown, black, bianco latte and lacquered in the 34 Ecoloursystem colours.

Self up: le composizioni freestanding caratterizzate dai piedini in alluminio. Un'ampia varietà di soluzioni compositive, definite da un'estetica ispirata alla massima leggerezza formale. I piedini, in tinta ai profili, sono previsti in finitura alluminio, brown, nero, bianco latte e laccata nei 34 colori Ecoloursystem.

Self up: die freistehenden Anlagen sind durch Aluminiumfüsse charakterisiert. Eine breite Vielfalt von Kombinationsmöglichkeiten ist durch eine formale Leichtigkeit gekennzeichnet. Die Füessen in der selben Farbe wie die Profile sind in Aluminium, Brown, nero, bianco latte und in den 34 Ecoloursystemfarben erhältlich.

Self up: les compositions autoportantes caractérisées par des pieds en aluminium. Une grande variété de compositions caractérisées par une esthétique inspirée par une légèreté formelle. Les pieds, dans la même finition des profils, sont disponibles en finition aluminium, brown, nero, bianco latte et lacqués dans les 34 couleurs Ecoloursystem.

Self up: las composiciones freestanding se caracterizan por los pies en aluminio. Una amplia variedad de composiciones, caracterizadas por una estética inspirada a la máxima ligereza formal. Las patas, en tinta con los perfiles, son disponibles en acabado aluminio, brown, negro, bianco latte y lacadas en los 34 colores Ecoloursystem.







Versatilità, coerenza, perfezione assoluta nella modularità geometrica: il sistema Self up prevede la soluzione libreria confermando le sue particolarità distintive. Una versione tipologica che trova posto in diversi ambienti della casa nei quali svolge la propria funzione conferendo stile e uniformità all'insieme.

Versatility, coherence, perfection in geometrical modularity: Self up system can be displayed as bookcase with distinctive characteristics. This typology finds the right place in different domestic areas with the same functionality, thus giving style and coherence to the environment.

Vielseitigkeit, Konsistenz, absolute Perfektion der geometrischen Kombinierbarkeit. Eine typologische Version, die in den verschiedenen Räumen des Hauses einsetzbar ist, und die Stil und Einförmigkeit verleiht.

Polyvalence, cohérence, perfection absolue de la modularité géométrique: le système Self up dans la version bibliothèque, toujours avec ses particularités distinctives. Version typologique qui trouve place dans plusieurs espaces de la maison, dans lesquelles Self remplit sa fonction avec style et uniformité à l'ensemble.

Versatilidad, coherencia, perfección absoluta en la modularidad geométrica: El sistema Self up ofrece la solución librería confirmando sus peculiaridades distintivas. Versión tipológica que encuentra lugar en varios ambientes en las cuales cumple su función y estilo, dando uniformidad al conjunto.





Settimanale *Chest of drawers*  
 Struttura *Structure*: 30 alluminio  
 Vetro *Glass*: 98 lino opaco  
 W 650 H 1319 D 470

Secretaire *Secretaire*  
 Struttura *Structure*: 14 brown  
 Vetro *Glass*: 99 caffè opaco  
 W 650 H 1319 D 470

Comodino *Bedside unit*  
 Struttura *Structure*: 36 blu Londra  
 Vetro *Glass*: 117 blu Londra opaco  
 W 650 H 359 D 470



Struttura *Structure*: 14 brown  
 Vetro *Glass*: 99 caffè opaco  
 Cassettoni con serratura *Drawers with key*: 19 rovere termotrattato  
 Piano scrittoio e cassetti interni  
 Writing desk and internal drawers: 153 similpelle castoro  
 Schienale *Back panel*: 68 specchio grigio  
 Illuminazione interna a led con sensore di accensione  
*Internal led lighting with sensor device*  
 W 650 H 1319 D 470

## Modularità Modular structure

Self - modularità P 470  
Self - modularity D 470

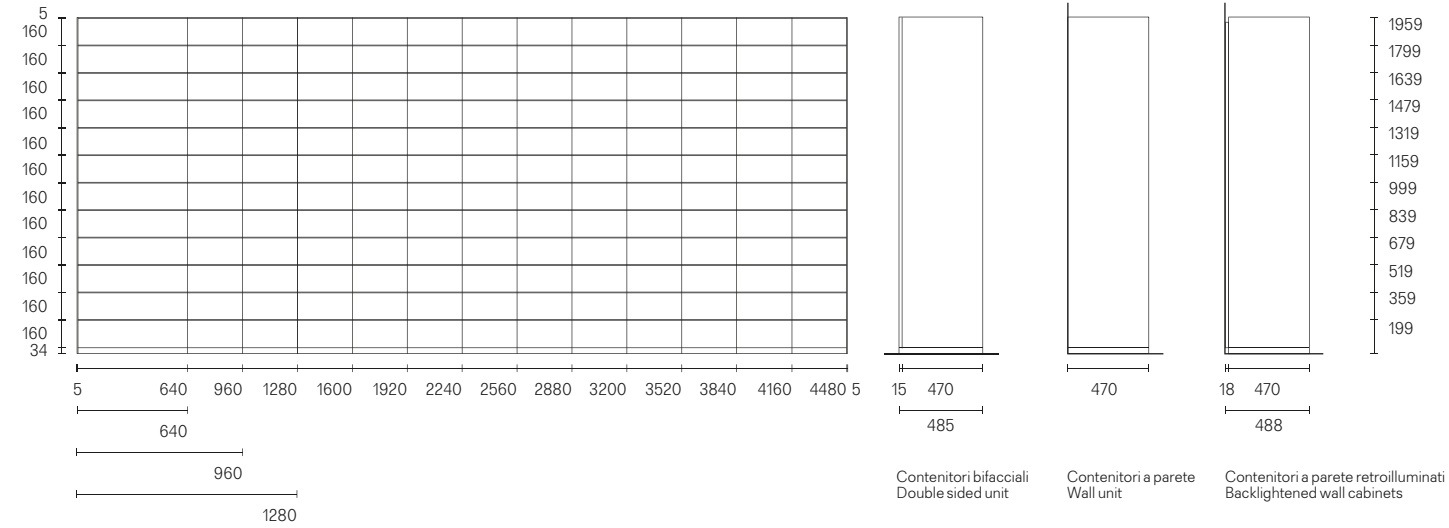

Self up - modularità P 470  
Self up - modularity D 470

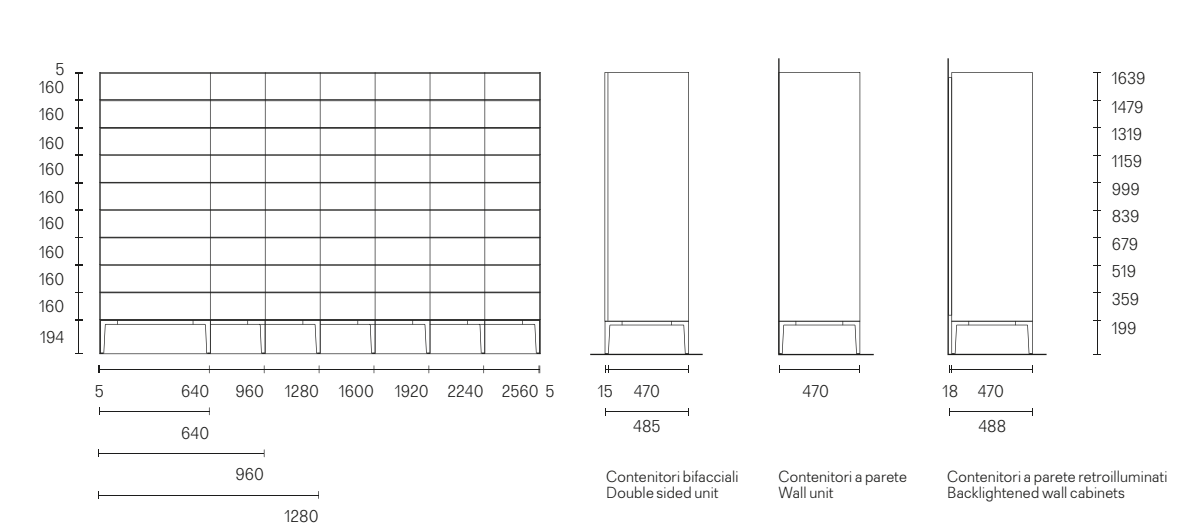

Self - modularità P 335  
Self - modularity D 335

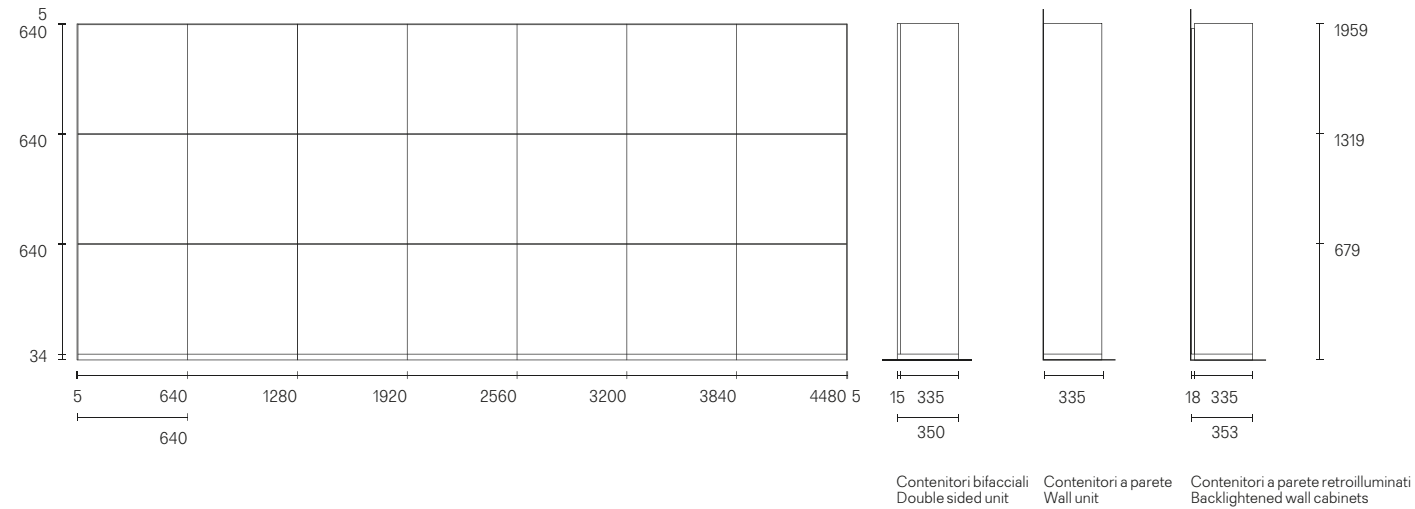

Self up - modularità P 335  
Self up - modularity D 335

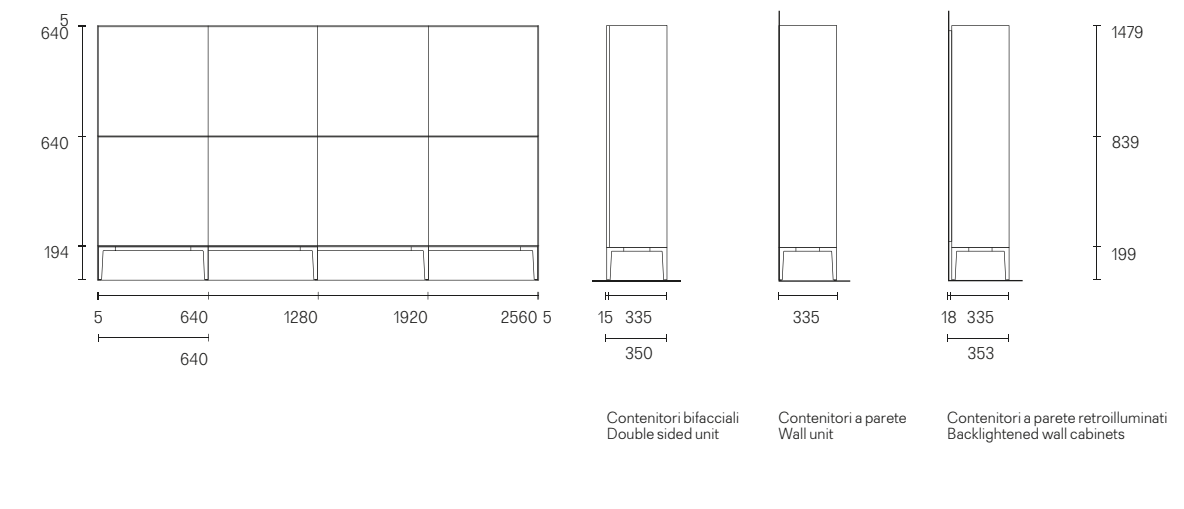

## Descrizione tecnica Technical description

Il sistema Self è costituito da contenitori a cassetti, con anta battente o ribalta, interamente rivestiti in vetro laccato o in gres. I vani a giorno sono disponibili in noce, rovere termotrattato e in legno laccato nei colori Ecolorsystem. I contenitori con larghezza 640, 960 e 1280 mm consentono di progettare nella massima libertà, grazie alla modularità a passo 320 mm. Le composizioni freestanding, disponibili in versione mono o bifacciale, sono dotate di zoccolo in alluminio oppure di piedini in pressofusione. Il profilo di aggancio a parete contiene il sistema di illuminazione a led e permette di creare composizioni sospese.

The Self system is composed by cabinets and drawers, with hinged or flap doors, entirely covered in lacquered glass or in gres. The open module are available in walnut, heat-treated oak and in lacquered wood in the Ecolorsystem colours. The cabinets with 640 and 960 mm width allow to project in complete freedom, thanks to the modularity multiple of 320 mm. The freestanding compositions, available in the mono or double-sided version, are equipped with an aluminium skirting or in die-casting aluminium feet. The wall hanging profile includes the led lighting system and allows to create suspended compositions.

Self System besteht aus Schubladenelementen, Klapp-türen oder Drehtüren aus lackiertem aus lackiertem Glas oder aus Gres. Die offenen Fächer sind in Nussbaum, thermobehandelte Eiche und lackiertem Holz in den Ecolorsystem-Farben erhältlich. Module mit 640 oder 960 mm Breite ermöglichen eine freie Projektierung, dank zu der Modularität mit Abstand 320 mm. Freistehenden Kompositionen sind auch mit Rückwand vorgesehen, mit Sockel aus Aluminium oder Druckguss Fussgestell. Wandbefestigungstruktur ist mit Led Beleuchtung ausgestattet und ermöglicht abgehängten Kompositionen zu realisieren.

Le système Self se compose de meubles tiroirs, avec porte battante ou abattante, entièrement recouverte de verre laqué ou en grès. Les niches ouvertes sont disponibles en noyer, chêne thermo traité et en bois laqué dans les couleurs Ecolorsystem. Les meubles avec largeur 640 et 960 mm permettent de concevoir en totale liberté, grâce à une modularité chaque 320 mm. Les compositions freestanding, disponibles dans la version simple ou double face, sont équipées avec socle en aluminium ou piétement en pression fusion d'aluminium. Le profil de support mural comprend le système d'éclairage à LED et permet de créer des compositions suspendues.

El sistema Self consta de contenedores con cajones, puerta batiente o abatible, totalmente cubiertos de cristal lacado o en gres. Los módulos abiertos están disponibles en nogal, roble termotrattado y en madera lacada en los colores Ecolorsystem. Los contenedores con anchura de 640 y 960 mm permiten diseñar en la máxima libertad, gracias a la modularidad en el paso 320 mm. Las composiciones freestanding, disponibles en versión simple o bifacial, son dotadas de zócalo en aluminio o pies en inyección. El perfil de fijación a la pared contiene el sistema de iluminación por leds y permite la creación de composiciones colgantes.

Self bold - modularità P 470  
Self bold - modularity D 470

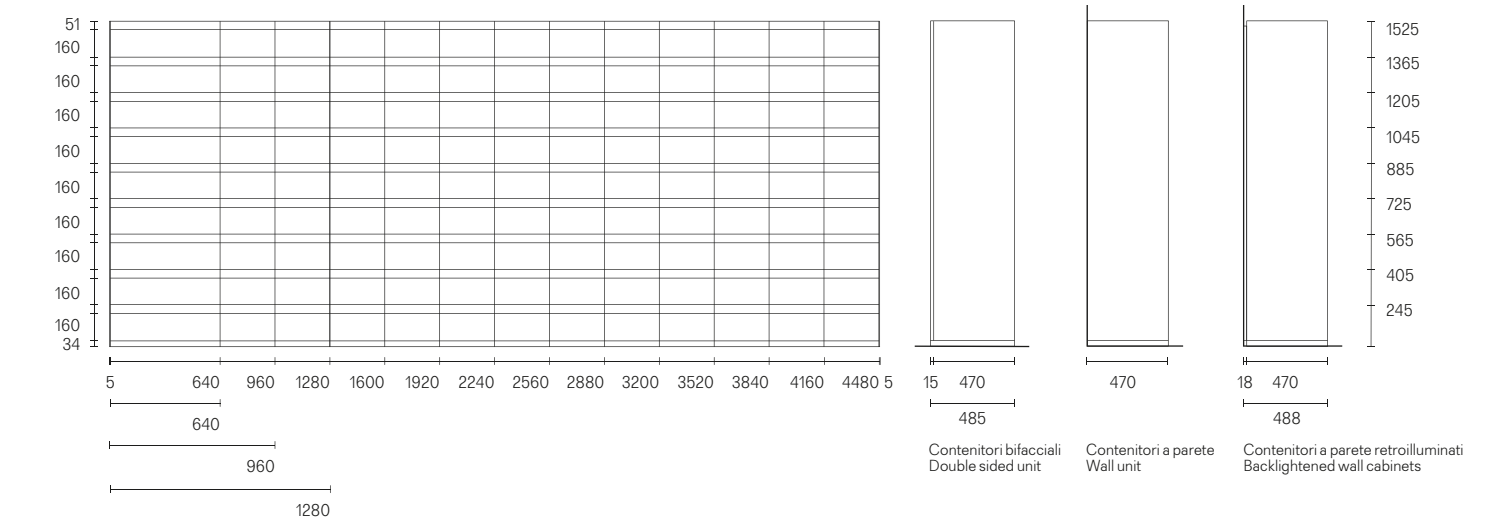

Day collection

Self, Self bold, Self up

**Componenti**  
**Components**

Top di finitura per versioni a parete P 335/470 e freestanding P 350/485  
Finishing top for wall versions D 335/470 and freestanding D 350/485

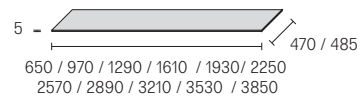
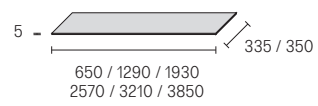

Zoccolo in alluminio  
Aluminum skirting

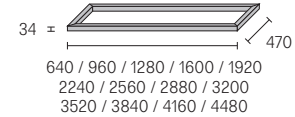
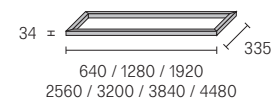

Basamento con piedini. Non disponibile per Self bold / Base with feet. Not available for Self bold

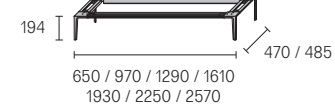

Fianco di finitura in vetro laccato per versioni a parete P 335/470 e freestanding P 350/485 / Terminal panel in lacquered glass for wall versions D 335/470 and freestanding D 350/485

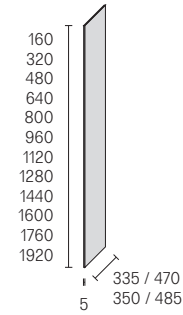

Schienale di finitura opzionale per versioni freestanding orizzontali e verticali  
Optional back panel for horizontal and vertical freestanding versions

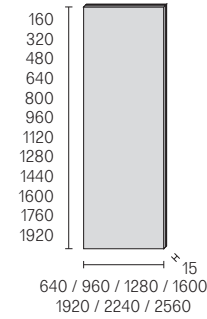

Fianco di finitura Self bold in alluminio  
Self bold aluminum finishing thickness

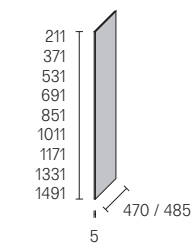

Profilo posteriore del top previsto per Self bold. Top di finitura Self bold in vetro o in marmo, spessore 51 mm, e in gres, spessore 5 mm / Rear profile of the top available for Self bold. Self bold glass or marble finishing top, thickness 51 mm, and gres finishing top, thickness 5 mm

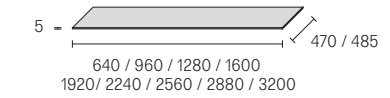
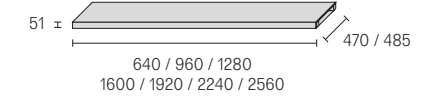
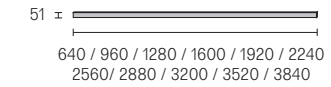

Telaio per contenitori sospesi retroilluminati. Non disponibile per Self up e Self bold con top in marmo / Frame for backlit suspended cabinets with back lighting system. Not available for Self up and Self bold with marble top

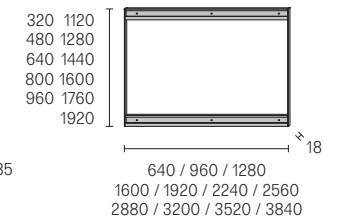

Contenitori con 1 e 2 cassetti push, guide ad estrazione parziale  
Cabinets with 1 and 2 push drawers, partial extraction runners

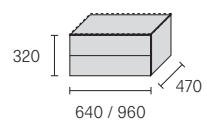
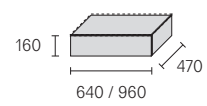

Contenitori con 1 e 2 cassettoni push, guide ad estrazione parziale  
Cabinet with 1 and 2 large push drawers, partial extraction runners

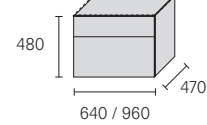
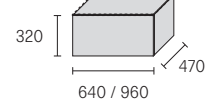

Contenitori con 1 e 2 cassetti e 1 cassettono push, guide ad estrazione parziale / Cabinet with 1 and 2 drawers and 1 push large drawer, partial extractable runners

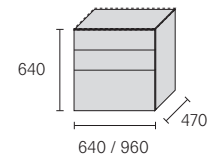
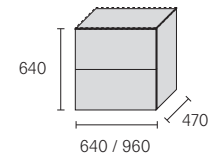

Contenitori con 3 e 4 cassetti push, guide ad estrazione parziale  
Cabinets with 3 and 4 push drawers, partial extractable runners

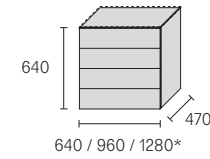
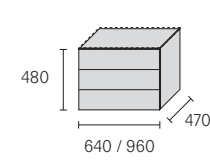

\*Disponibile solo per H 640. / Available only for H 640.

Tovaglietta opzionale in similpelle per fondo cassetti  
Optional synthetic leather mat for drawer bottom



Ripiano opzionale interno in vetro con profilo perimetrale in alluminio  
Optional internal glass shelf with aluminum perimeter profile

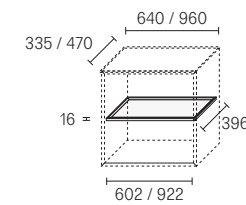

Cassetto interno in legno per contenitore con anta battente e anta ribalta  
Wooden internal drawer for unit with hinged door and flap door

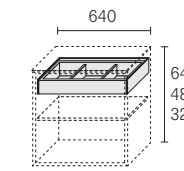

Illuminazione a led interna opzionale per vano con anta battente e anta a ribalta con sensore di presenza integrato. Passacavi opzionale, in vetro o gres per il top e in alluminio per lo schienale  
Optional internal led lighting for hinged and flap door unit with integrated presence sensor. Optional cable cut in glass or gres for the top and in aluminium for the back panel

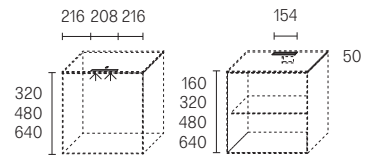

Contenitori con anta a ribalta  
Flap door cabinets

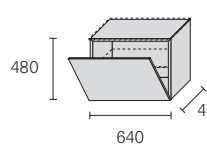
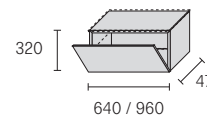
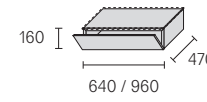

Contenitore vetrina in noce o in rovere termotrattato con ante battenti dotate di serratura / Walnut or heat-treated oak cabinet with transparent glass hinged doors equipped with lock

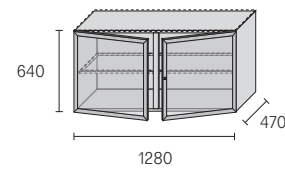

Contenitori con anta battente  
Wall fixed hinged door units

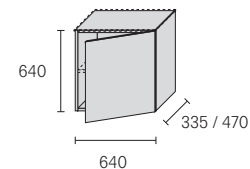
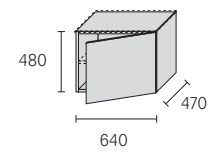

Contenitore con ante battenti  
Hinged door cabinet

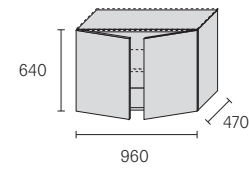
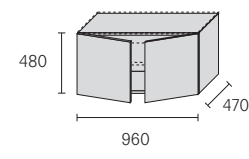

Vani a giorno laccati, in noce o in rovere termotrattato H 160 / Lacquered, walnut or heat-treated oak open modules H 160

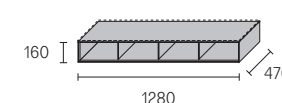
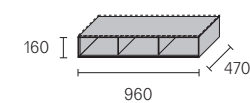
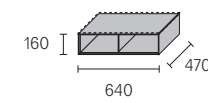

Vani a giorno laccati, in noce o in rovere termotrattato H 320 mm / Lacquered, walnut or heat-treated oak open modules H 320 mm

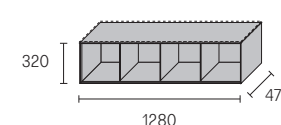
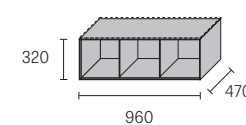
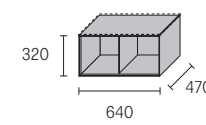

Vani a giorno laccati, in noce o in rovere termotrattato H 640 con schienali interni opzionali in specchio grigio  
Lacquered, walnut or heat-treated oak open module H 640 with optional back panel in gray mirror

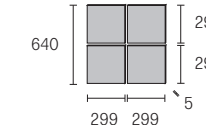
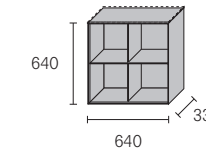

Vani tecnici a giorno laccati, in noce o in rovere termotrattato, ripiano laccato opzionale P 405 per vano H 320  
Technical lacquered, walnut or heat-treated oak open modules, optional lacquered shelf D 405 for module H 320

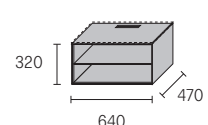
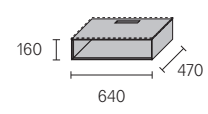



Design Giuseppe Bavuso

## Abacus living

Abacus living is a new conception of the living room system. The design consists of a back panel in lacquered glass, a pure surface with light and reflections, which holds storage units made entirely of glass including drawers and sliding doors, extremely thin shelves and display cases with flap doors. The back panels are equipped with a led lighting system in the upper and lower part. The wide choice of cabinets and accessories dedicated to the living area and to the HiFi allows to create solutions, in line with the most contemporary practice, characterized by the aesthetics of the glass.

Abacus living è una nuova concezione del sistema giorno. Il progetto si compone di una boiserie di vetro laccato, superficie pura che vive di luce e riflessi, su cui si innestano contenitori interamente in vetro con cassetti e con ante scorrevoli, mensole di sottilissimo spessore e vetrine con ante a ribalta. Gli schienali sono dotati di sistema di illuminazione a led nella parte superiore e inferiore. L'ampia scelta di contenitori e accessori dedicati all'area living e all'HiFi consente di formulare soluzioni in linea con le abitudini più contemporanee, caratterizzate dall'estetica del vetro.

Abacus living ist eine neue Konzeption des Wohnsystems. Es besteht aus einer Boiserie aus lackiertem Glas, eine reine Oberfläche, die von Licht und Reflexen lebt und in die sich Glasschränke, hauchdünne Konsolen und Vitrinen mit Klapptüren einfügen. Die Rückwände sind mit einem Led-Beleuchtungssystem im oberen und unteren Teil ausgestattet. Die große Auswahl an Schrankelementen und Zubehör für den Wohnbereich und HiFi gestattet Lösungen, die mit dem zeitgenössischen Geschmack im Einklang stehen und von der Ästhetik des Glases charakterisiert sind.

Abacus living est une nouvelle conception du système jour. Le système se compose d'une boiserie en verre laqué, une surface pure qui vit de lumière et de reflets, sur laquelle se greffent des éléments de rangement entièrement en verre avec des tiroirs et des portes coulissantes, des étagères d'une épaisseur très fine et des vitrines avec des portes abattantes. Les panneaux de fond sont équipés d'un système d'éclairage à led dans la partie supérieure et inférieure. Le grand choix d'éléments de rangement et d'accessoires dédiés à la zone jour et à la HiFi, permet de formuler des solutions en ligne avec les habitudes les plus contemporaines, caractérisées par l'esthétique du verre.

Abacus living es una nueva concepción del sistema para la zona de día. El proyecto está formado por una "boiserie" de cristal laccado, superficie pura que vive de luz y reflejos, en la que se integran muebles contenedores todos de cristal con cajones y con puertas correderas, estantes de un espesor muy fino y vitrinas con puertas abatibles. Los paneles traseros están equipados con un sistema de iluminación de led en la parte superior e inferior. La amplia selección de contenedores y accesorios destinados al área living y al HiFi, permite formular soluciones que encajan a la perfección con los estilos contemporáneos, caracterizados por la estética del cristal.











## Modularità Modular structure

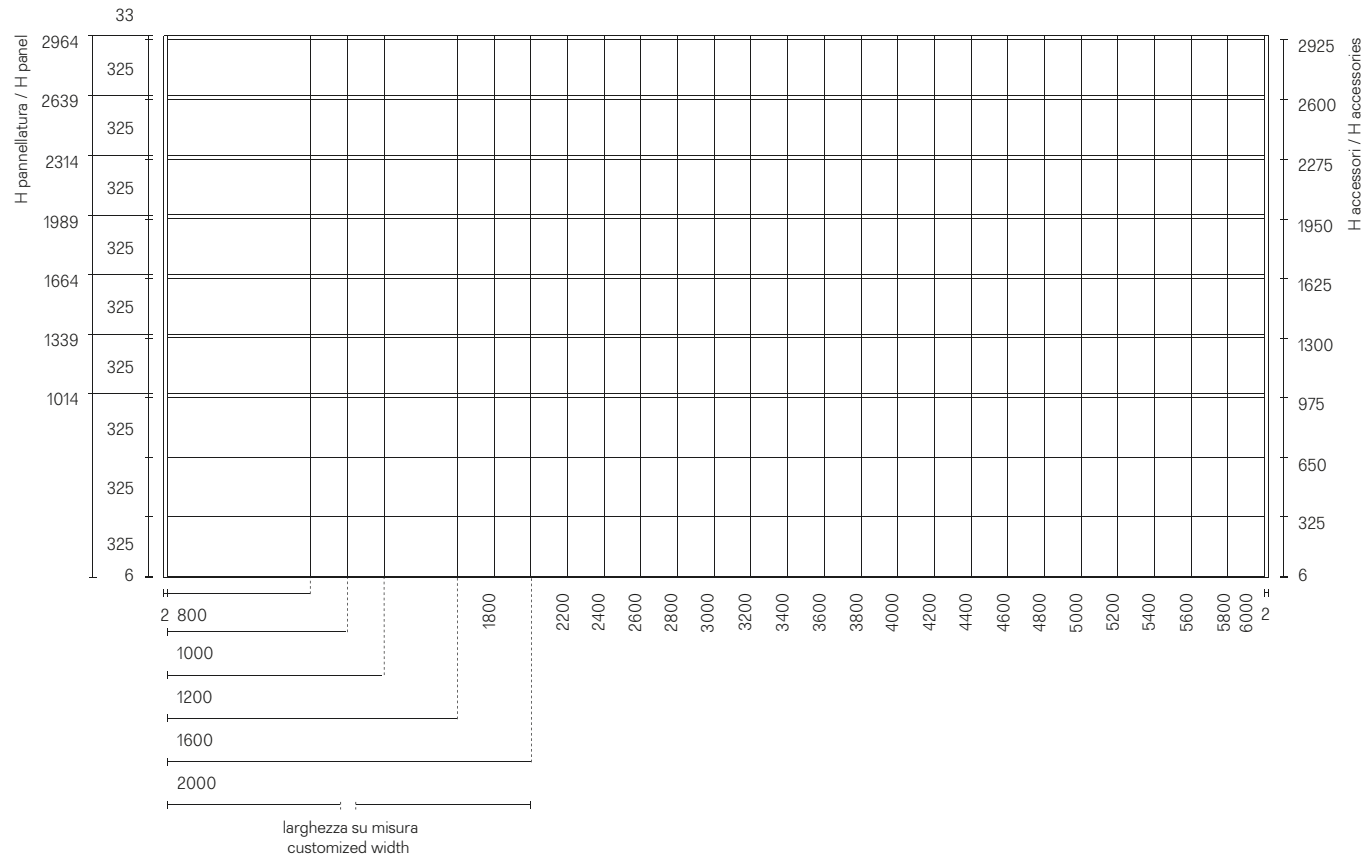

## Descrizione tecnica Technical description

La modularità del sistema Abacus living si basa su pannelli a parete in vetro laccato disponibili in 5 larghezze e 7 altezze. Il pannello, il ripiano e la panca a terra sono disponibili in 5 larghezze, con la possibilità di riduzione a misura. Tutti gli accessori sono disponibili in 70 tinte laccate ecolorsystem.

The modularity of the Abacus living system is based on wall fixed panels in lacquered glass available in 5 widths and 7 heights. The panel, the shelf and the floor bench are available in 5 different widths, with the possibility to reduce them on size. All the accessories are available in 70 tonalities of the Ecolorsystem colours.

Die Modularität des Abacus living Systems basiert auf lackierten Glaswandplatten, die in 5 Breiten und 7 Höhen erhältlich sind. Die Platte, der Fachboden und die Bodenbank sind in 5 Breiten erhältlich, mit der Möglichkeit, sie zu nach Maß zu reduzieren. Alle Zubehörteile sind in 70 Ecolorsystem lackierten Tönen erhältlich.

La modularité du système Abacus living est basée sur des panneaux au mur en verre laqué disponibles en 5 largeurs et 7 hauteurs. Le panneau, l'étagère et la base au sol sont disponibles en 5 largeurs, avec la possibilité de réduction sur mesure. Tous les accessoires sont disponibles en 70 couleurs ecolorsystem.

El sistema modular Abacus living se basa en paneles a pared en cristal lacado disponibles en 5 anchuras y 7 alturas. El panel, el estante y la base son disponibles en 5 anchuras, con la posibilidad de reducirlos a medida. Todos los elementos accesorios son disponibles en 70 tintas lacadas ecolorsystem.

## Componenti Components

Pannello in vetro laccato e temperato, struttura in estruso di alluminio anodizzato. Profilo laterale in alluminio laccato. Illuminazione superiore e inferiore a led / Panel in lacquered and tempered glass, structure in extruded anodized aluminium. Lacquered aluminium side profile, upper and lower led lighting

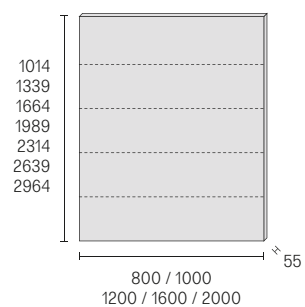

Pannello con struttura a scomparsa per tv lcd/led con 1 foro inferiore 260 x 86 mm o con 1 passacavi in vetro 260 x 86 mm / Panel with hidden frame for lcd/led tv with 1 lower hole, 260 x 86 mm or 1 glass cable-passage, 260 x 86 mm

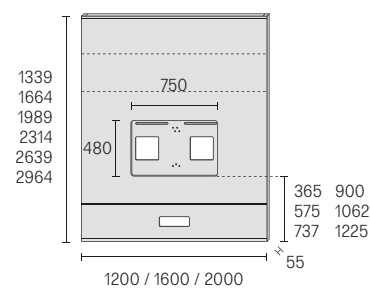

Staffa a parete per composizioni con pannelli sospesi / Wall fixing brackets for compositions with suspended panels

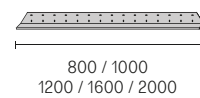

Braccio estensibile porta tv lcd/led in color antracite / Extensible support for lcd/led tv in dark grey colour

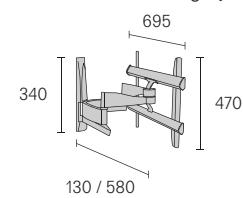

Illuminazione superiore e inferiore a led / Upper and lower led lighting



## Componenti Components

Ripiano laccato e stratificato in MDF rivestito da una doppia lastra di alluminio. Illuminazione a led opzionale / Laminated lacquered shelf in MDF, covered by a double aluminium sheet. Optional led lighting

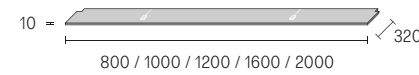

Ripiano in vetro temperato / Shelf in tempered glass

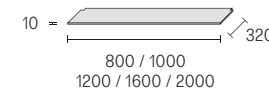

Top di finitura unico in vetro laccato, per basi e contenitori sospesi / Single top in lacquered glass, for floor bases and suspended cabinets

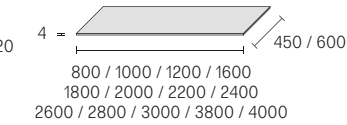

Top di finitura unico in legno o in gres, per basi e contenitori sospesi / Single top in wood, or gres, for floor bases and suspended cabinets

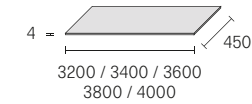

Panca a terra in vetro laccato temperato, zoccolo in alluminio e piedini regolabili / Floor bench in tempered lacquered glass with aluminium structure and adjustable feet

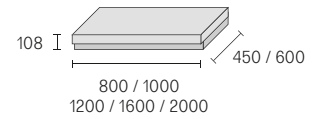

Vetrina sospesa laccata con anta a ribalta in vetro trasparente, acidato o laccato. Illuminazione a led opzionale / Lacquered suspended cabinet with flap door with transparent, satined or lacquered glass. Optional led lighting

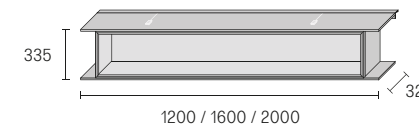

Anta scorrevole completa di binario di scorrimento e spalle in vetro trasparente o trasparente grigio / Sliding door equipped with sliding carriage and side panels in transparent or transparent grey glass

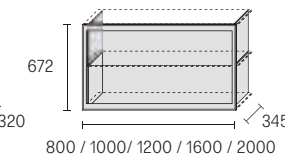
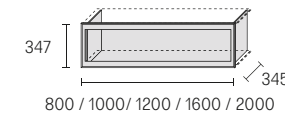

Anta scorrevole completa di binario di scorrimento e spalle in vetro trasparente o trasparente grigio / Sliding door equipped with sliding carriage and side panels in transparent or transparent grey glass

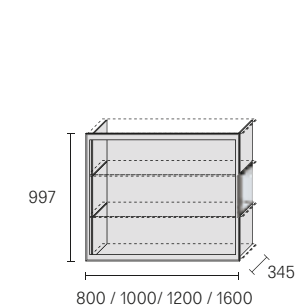

Anta scorrevole completa di binario di scorrimento e spalle in vetro trasparente o trasparente grigio / Sliding door equipped with sliding carriage and side panels in transparent or transparent grey glass

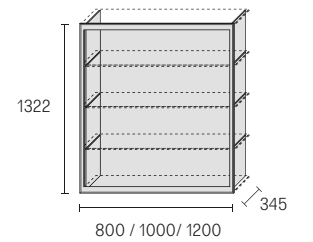

Base doppia in vetro laccato temperato con cassetto push o con anta a ribalta, P 600 / Double base unit in tempered lacquered glass with push drawer or with flap door, D 600

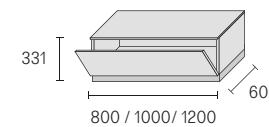
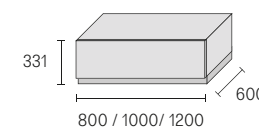

Base singola e doppia in vetro laccato temperato, gres o legno con cassetto push o con anta a ribalta, P 450 con pannello in vetro, P 458 a parete, P 453 bifacciale / Single and double base unit in tempered lacquered glass, gres or in wood, with push drawer or with flap door. D 450 with glass panel, D 458 wall suspended unit, D 453 double sided

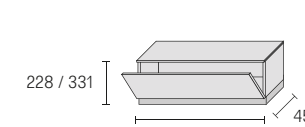
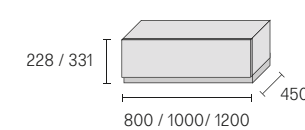

Contenitore singolo e doppio sospeso in vetro laccato temperato, gres o in legno con cassetto push in alluminio con guide ad estrazione totale o anta a ribalta, P 450 con pannello in vetro, P 458 a parete / Single and double wall suspended unit in tempered glass, gres or in wood, with push drawer or with flap door. D 450 with glass panel, D 458 wall suspended unit

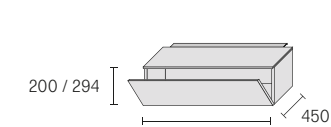
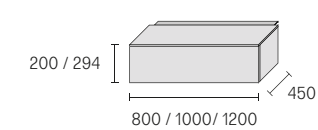

Tovaglietta opzionale in similpelle per fondo cassette / Optional synthetic leather mat for drawer bottom

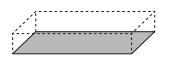

# Complements

379 Flat system, 389 Flat, 395 Long Island, 403 Manta,  
413 Planet, 419 Tray, 423 Sixty coffee table, 429 Sixty,  
433 Ala, 437 Dolmen, 441 Eos



Design Giuseppe Bavuso

## Flat system

System of tables designed for professional spaces with extruded aluminum structure and glass top. Natural evolution of the table, Flat System provides for configurations with terminal and side workspace, and a wide range of specific equipment and accessories. The proposal allows to meet the typical needs of the new working areas, providing practical and functional solutions for every operating condition.

Sistema di tavoli attrezzati per spazi professionali con struttura in alluminio estruso e piani in vetro. Naturale evoluzione del tavolo, Flat System prevede configurazioni con elementi terminali, laterali e un'ampia serie di attrezzature e accessori specifici. La proposta permette di interpretare le tipiche esigenze dei nuovi spazi di lavoro, fornendo soluzioni concrete e funzionali per ogni condizione operativa.

Ein Tischsystem für professionelle Räume, das mit extrudierter Aluminium-Struktur und Glasplatten ausgestattet ist. Flat System ist die natürliche Evolution des Tisches und bietet Verbindungen mit End- und Seitenelementen und eine große Bandbreite an spezifischen Geräten und Zubehör. Das Angebot ermöglicht es, die typischen Bedürfnisse neuer Arbeitsräume zu interpretieren und praktische und funktionelle Lösungen für jeden Betriebszustand anzubieten.

Système de tables équipées pour les espaces professionnels avec structure en aluminium extrudé et plateau en verre. Évolution naturelle de la table, Flat System fournit des configurations avec des éléments d'extrémité, latéraux et une large gamme d'équipements et d'accessoires spécifiques. La proposition permet d'interpréter les besoins typiques des nouveaux espaces de travail, en fournissant des solutions pratiques et fonctionnelles pour chaque condition de fonctionnement.

Sistema de mesas equipadas para espacios profesionales con estructura en aluminio extruido y encimeras en cristal. Evolución natural de la mesa, Flat System prevé configuraciones con elementos terminales, laterales y una amplia gama de equipos y accesorios específicos. La propuesta permite interpretar las necesidades típicas de los nuevos espacios de trabajo, proporcionando soluciones prácticas y funcionales para cada condición operativa.

Composizione lineare con piano terminale  
*Linear composition with terminal workspace*  
 Struttura *Structure*: 53 bianco neve  
 Top *Top*: 95 bianco neve opaco  
 Alzatina in vetro *Glass upstand*: 02 acidato extrachiaro  
 Portadocumenti *Document holders*: 53 bianco neve  
 W 5600 H 734 D 1610

Nella foto *In this photo*  
 Sistema interparete  
 Wall partition system: Spazio  
 Porta scorrevole *Sliding door*: Velaria









**Modularità**  
**Modular structure**

Composizioni lineari  
Linear composition

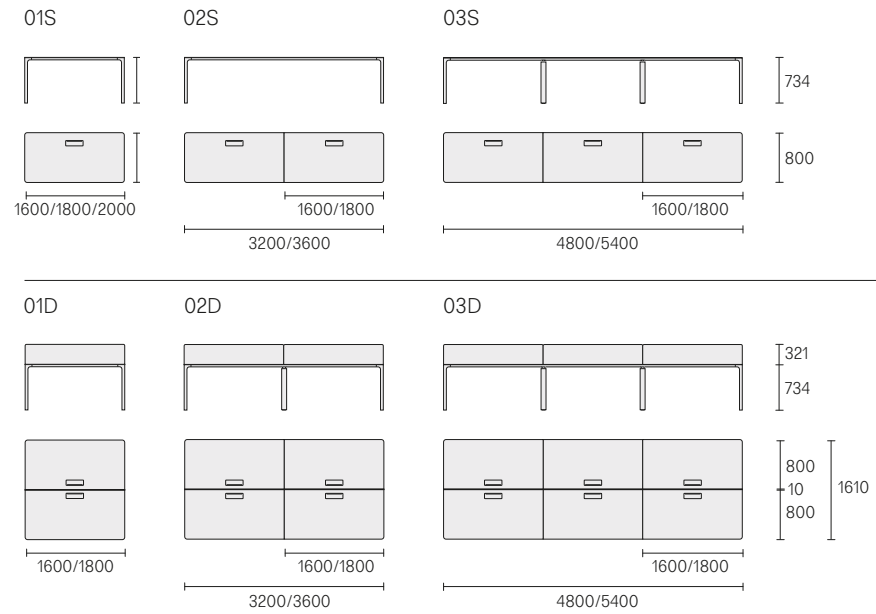

Composizioni lineari con piano terminale / Linear composition with terminal workspace

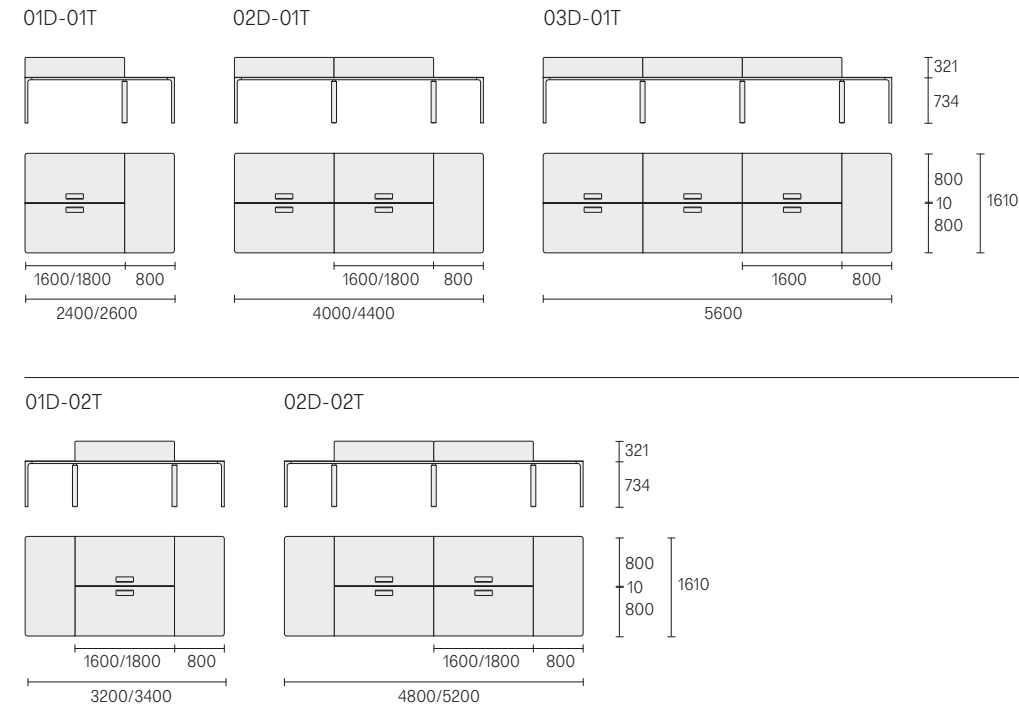

Composizioni angolari con piano laterale e terminale / Corner compositions with side and terminal workspace

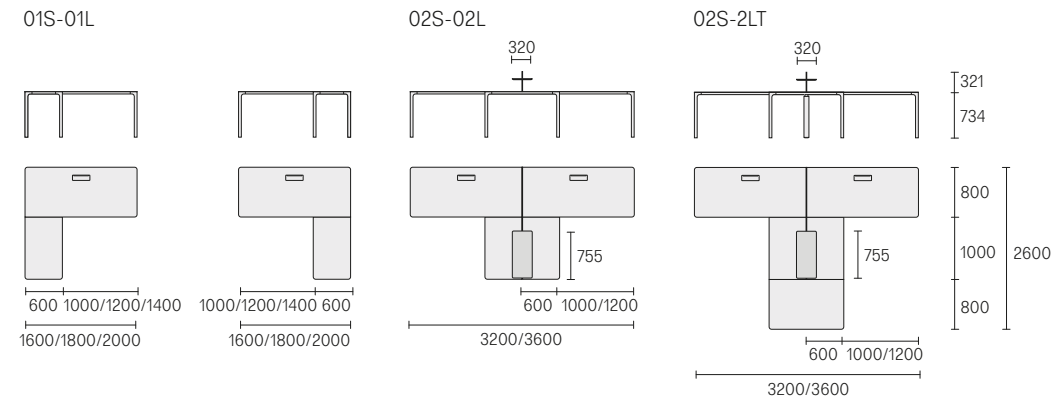

01D-02L 01D-01T-02L

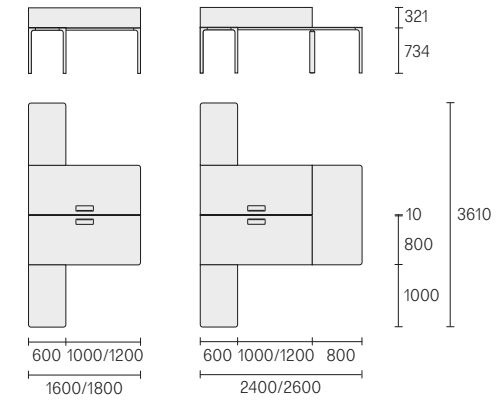

Composizioni angolari con piano laterale e terminale / Corner compositions with side and terminal workspace

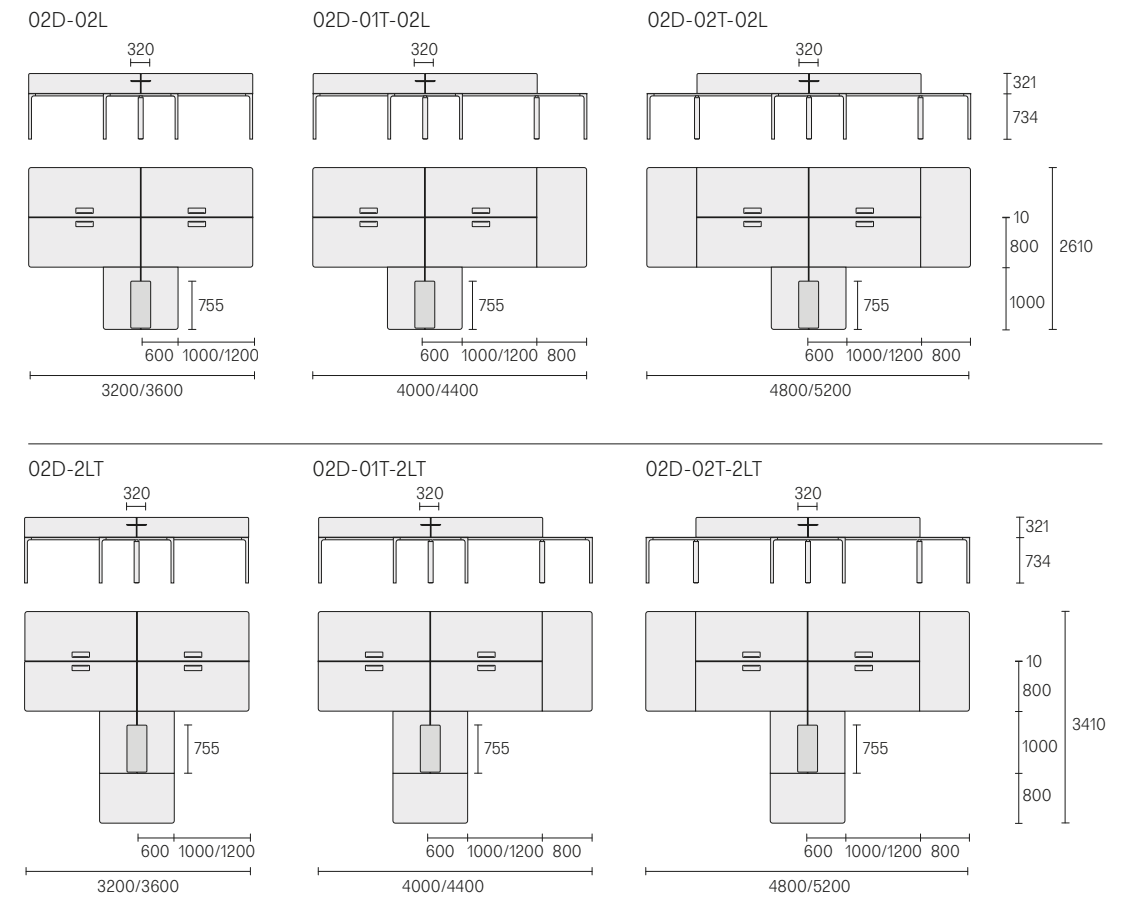

Composizioni a croce con piano laterale e terminale / Cross composition with side and terminal workspace

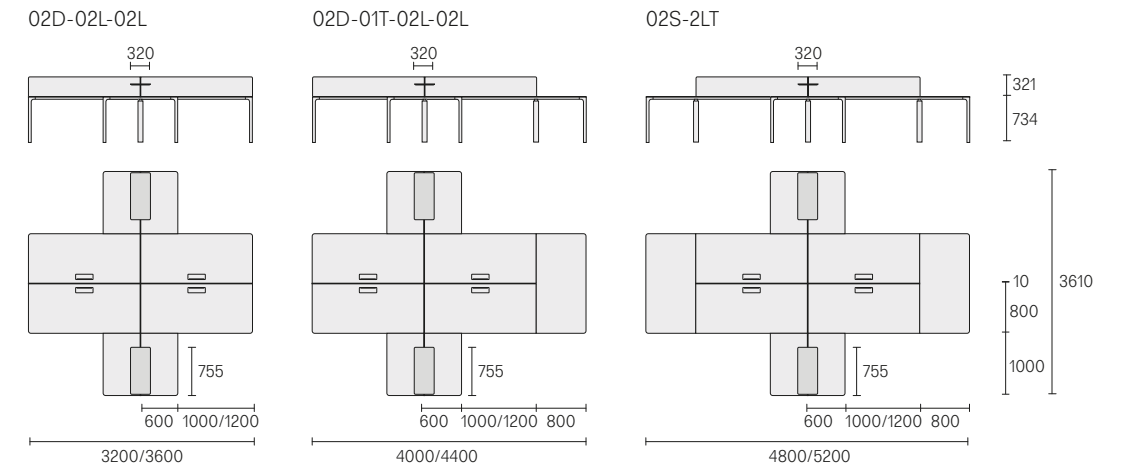



Design Giuseppe Bavuso

## Flat

A system of tables characterized by the particular design of the structural aluminium profile. The wide variety of dimensions and the free combination of the aluminum finishes, glass and veneers of the collection, allows Flat to interpret different environments, from domestic to professional spaces.

Un sistema di tavoli caratterizzato dal particolare disegno del profilo strutturale in alluminio. La varietà dimensionale e la libera combinazione tra le finiture dell'alluminio, dei vetri e delle essenze della collezione, permette a Flat di interpretare ambienti diversi, dalle situazioni domestiche agli spazi professionali.

Ein Tischsystem das sich durch das besondere Design des Strukturprofils aus Aluminium auszeichnet. Die Massvielfalt und die freie Kombination von Aluminium, Holz und Glas der Kollektion ermöglichen es mit Flat in verschiedenen Umgebungen eine Atmosphäre in Wohnsituationen bis hin zu professionellen Räumen zu interpretieren.

Un système de tables caractérisé par la conception particulière du profil structurel en aluminium. Les diverses dimensions disponibles et la combinaison libre des finitions de l'aluminium, des verres et des bois de la collection, permettent à Flat de s'insérer dans différents lieux soit domestiques que professionnels.

Un sistema de mesas caracterizado por el diseño particular del perfil estructural en aluminio. La variedad dimensional y la combinación libre de acabados de aluminio, vidrios y esencias de la colección, permite a Flat interpretar diferentes ambientes, desde las situaciones domésticas hasta los espacios profesionales.







Design Giuseppe Bavuso

## Long island

A system of tables with an essential and refined look, consistent with the unique Rimadesio philosophy. Available in different shapes and dimensions, as well as in the new extensible version, Long Island combines rigorous aesthetic, technological research, and expressive innovation. The unique variety of the available finishes allows a natural combination with the other proposals of the collection.

Un sistema di tavoli dall'immagine essenziale e ricercata, espressione coerente della particolare filosofia Rimadesio. Disponibile in diverse dimensioni e formati, oltre che nella inedita versione allungabile, Long Island coniuga estetica rigorosa, ricerca tecnologica e originalità espressiva. L'esclusiva varietà delle finiture previste consente una naturale combinazione con le proposte della collezione.

Tischsystem mit reinem und preiswertem Aussehen, das der Philosophie Rimadesio entspricht. Long Island ist in verschiedenen Massen, Formen, und als Ausziehversion verfügbar. Long Island verbindet strikte Ästhetik, technologische Forschung zusammen mit der ausdrucksvollen Originalität. Mehrere Ausführungen, die mit anderen Produkten der Kollektion sich kombinieren können.

Un système de tables d'une image essentielle et recherchée, qui exprime avec cohérence la philosophie particulière de Rimadesio. Disponible en différentes dimensions et formes, ainsi que dans la nouvelle version à rallonges, Long Island combine une esthétique rigoureuse avec la recherche technologique et l'originalité d'expression. La variété unique de finitions disponibles permet une combinaison naturelle avec les propositions de la collection.

Un sistema de mesas de la imagen esencial y refinada, expresión coherente de la particular filosofía de Rimadesio. Disponible en diferentes tamaños y formatos, así como en la versión extensible. Long Island conjuga la estética rigurosa, la investigación tecnológica y la originalidad expresiva. La exclusiva variedad de acabados disponibles permite una combinación natural con las propuestas de la colección.

Struttura Structure: 69 palladio  
Piano in vetro Glass top: 108 bianco latte opaco  
W 3000 H 750 D 1100

Nella foto In this photo  
Porte scorrevoli Sliding doors: Sail

Complements











Design Giuseppe Bavuso

## Manta

A system of tables expressing Rimadesio's commitment to achieve aesthetic originality through research and technological innovation. The modular structure in high pressure die-cast aluminium and the central rod in tempered aluminium alloy ensure maximum reliability with minimum thickness profiles, while the modular design of the structure allows exceptional dimensions.

Un sistema tavoli che esprime con chiarezza l'impegno di Rimadesio nel raggiungere l'originalità estetica attraverso la ricerca e l'innovazione tecnologica. La struttura modulare in alluminio pressofuso e il tirante centrale in lega di alluminio temperato consentono di assicurare la massima affidabilità con profili di minimo spessore mentre la concezione modulare della struttura permette la declinazione su dimensioni eccezionali.

Ein System von Tischen das den Auftrag von Rimadesio mit Klarheit und Besonderheit über die Forschung und innovativen Technologie vereint. Die modulare Struktur aus stranggepresstem Aluminium mit hohem Druck und der zentralen Zugstange aus einer temperierten Aluminiumlegierung ermöglicht eine maximale Zuverlässigkeit mit Profilen aus einem minimalen Durchmesser modulare Formen von aussergewöhnlichen Dimensionen zu entwickeln.

Un système de tables qui exprime clairement l'engagement de Rimadesio à réaliser une originalité esthétique grâce à la recherche et à l'innovation technologique. La structure modulaire en aluminium moulé sous haute pression et la tige centrale en alliage d'aluminium trempé garantissent une fiabilité maximale avec des profils d'épaisseur minimum, tandis que la conception modulaire de la structure permet des dimensions exceptionnelles.

Un sistema de mesas que expresa claramente el compromiso de Rimadesio para lograr la originalidad estética a través la investigación y innovación tecnológica. La estructura modular en aluminio fundido a alta presión y el tensor central en aleación de aluminio templado garantizan la máxima fiabilidad con perfiles de espesor mínimo, mientras que el diseño modular de la estructura permite la declinación en dimensiones excepcionales.

Struttura Structure: 14 brown  
Top in marmo Marble top: 180 emperador  
W 2400 H 740 D 1060



Struttura *Structure*: 18 nickel nero  
Top in marmo *Marble top*: 181 nero marquinia  
W 2400 H 740 D 1060

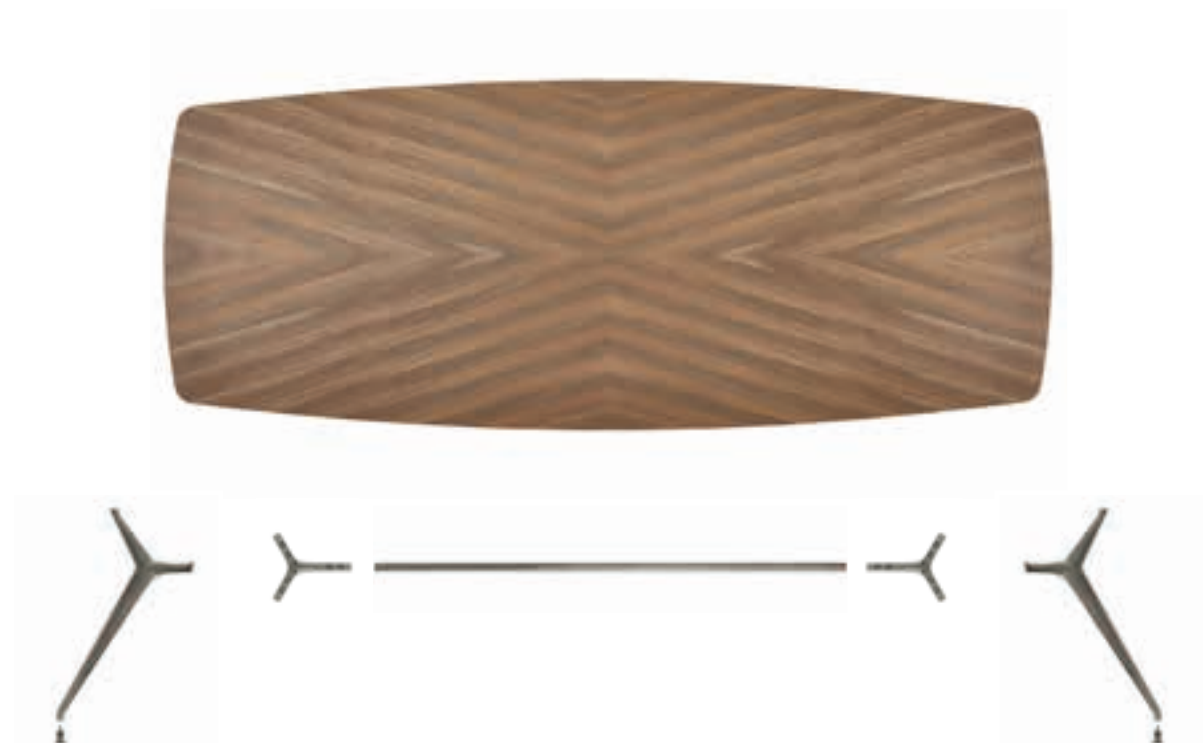

Struttura *Structure*: 83 piombo  
Top *Top*: 15 noce  
W 3000 H 740 D 1180







Struttura *Structure*: 303 bronzo  
Top *Top*: 15 noce  
Piano girevole *Lazy susan top*: 136 bronzo opaco  
Ø 1800 H 740

Manta →

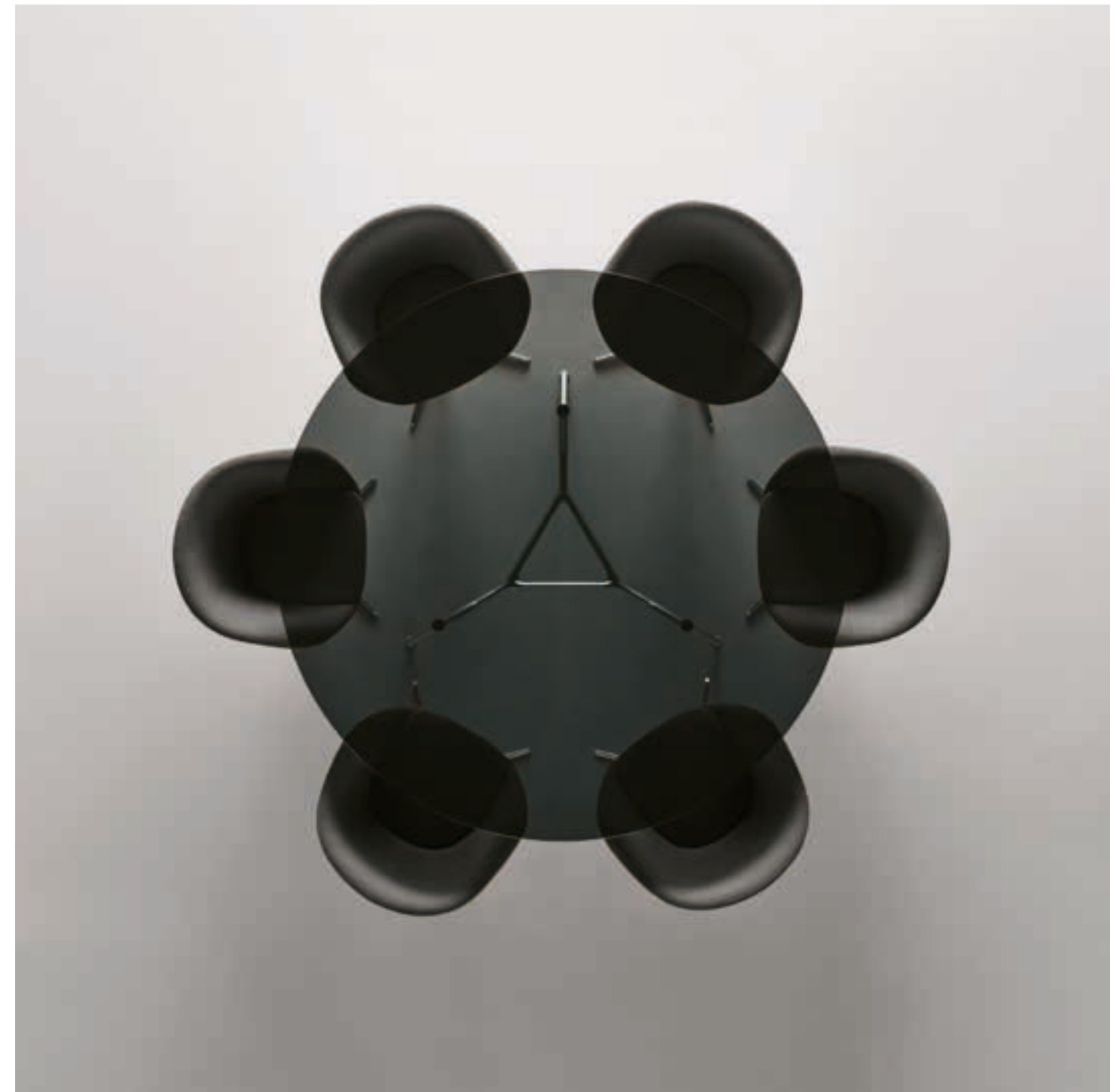

Struttura *Structure*: 304 platino  
Vetro *Glass*: 63 grigio trasparente  
Ø 1800 H 740

Complements

Manta →



Design Giuseppe Bavuso

## Planet

Light but fluid structure, a design based on materials contrast and on the difference between pure geometries of the tops, with various dimensions and thickness, and the structure dynamism, proper of the support structure. Planet combines its sophisticated style with flexible shapes, dimensions and heights.

Una struttura leggera ma organica, un progetto che gioca sul contrasto fra i materiali e sulla differenza tra le geometrie perfette dei piani, diversi per dimensione e spessore, e il dinamismo delle gambe che viene esteso a tutta la struttura di sostegno. Planet associa la sua sofisticata eleganza alla flessibilità compositiva determinata da figure, dimensioni e altezze diverse.

Eine leichte, aber organische Struktur, ein Projekt, das auf den Kontrast zwischen den Materialien und den Unterschied zwischen den perfekten Geometrien der Böden, die sich in Größe und Dicke unterscheiden, und der Dynamik der Beine, die sich auf die gesamte Tragstruktur erstreckt, anspielt. Planet verbindet seine raffinierte Eleganz mit seiner Kombinationsflexibilität, die durch verschiedene Formen, Größen und Höhen bestimmt wird.

Une structure légère mais organique, un projet qui joue sur le contraste entre les matériaux et la différence entre les géométries parfaites des plateaux, différentes en taille et en épaisseur, et le dynamisme des piètements, qui s'étend à toute la structure de support. Planet associe son élégance sophistiquée à la flexibilité de composition déterminée par différentes formes, dimensions et hauteurs.

Una estructura ligera pero orgánica, un proyecto que juega con el contraste entre los materiales y con la diferencia entre las geometrías perfectas de las encimeras, diferentes en tamaño y grosor, y el dinamismo de las patas que se extiende a toda la estructura de soporte. Planet combina su sofisticada elegancia con la flexibilidad compositiva determinada por figuras, tamaños y alturas diferentes.

Tavolino quadrato *Square table*  
Struttura *Structure*: 18 nickel nero  
Top in marmo *Marble top*: 180 emperador  
Sottopiano *Lower top*: 84 moro lucido  
W 1200 H 360 D 1200

Tavolino tondo *Round table*  
Struttura *Structure*: 18 nickel nero  
Top *Top*: 63 grigio trasparente  
Sottopiano *Lower top*: 88 grigio scuro lucido  
Ø 500 H 480





Tavolino tondo *Round table*  
 Struttura *Structure*: 303 bronzo  
 Top *Top*: 84 moro lucido  
 Sottopiano *Lower top*: 300 rame lucido  
 Ø 1100 H 360



Struttura *Structure*: 300 rame  
 Top in marmo *Marble top*: 182 rosso lepanto  
 Sottopiano *Lower top*: 300 rame lucido  
 Ø 1100 H 360



Struttura *Structure*: 303 bronzo  
 Top in marmo *Marble top*: 183 noir Saint Laurent  
 Sottopiano *Lower top*: 84 moro lucido  
 W 1600 H 480 D 450



Tavolino quadrato *Square table*  
 Strutture *Structure*: 31 alluminio lucido  
 Top *Top*: 63 grigio trasparente  
 Sottopiano *Lower top*: 85 tufo lucido  
 W 600 H 360 D 600

Tavolino rettangolare *Rectangular table*  
 Strutture *Structure*: 18 nickel nero  
 Top in marmo *Marble top*: 181 marquinia  
 Sottopiano *Lower top*: 88 grigio scuro lucido  
 W 1600 H 480 D 450

Tavolino tondo *Round table*  
 Strutture *Structure*: 303 bronzo  
 Top in marmo *Marble top*: 180 emperador  
 Sottopiano *Lower top*: 303 bronzo lucido  
 Ø 500 H 480



Design Giuseppe Bavuso

## Tray

Available in two different heights and six dimensions, the Tray coffee tables can be combined with different materials. Characterized by an essential design, they fit with extreme versatility the domestic requirements, from the living to the night area. The top in lacquered glass, marbles or walnut veneered inlay, can be easily combined with the finishing of the aluminium structures.

Disponibili in due altezze e sei dimensioni, i tavolini Tray si prestano alla combinazione di figure e materiali diversi. Caratterizzati da un design essenziale, si adattano con estrema versatilità alle esigenze domestiche, dall'area living alla zona notte. I piani in vetro laccato, marmo ed essenza di noce ad intarsio, sono abbinabili in libertà alle finiture delle strutture in alluminio.

Die Tray Couchtische sind in zwei Höhen und sechs Größen erhältlich und eignen sich für die Kombination verschiedener Formen und Materialien. Sie zeichnen sich durch ein essentielles Design aus und passen sich mit extremer Vielseitigkeit an die häuslichen Bedürfnisse an, vor allem den Wohn- und Schlafbereich. Die einzelnen Fachböden aus lackiertem Glas, Marmor und Intarsien aus Nussbaumessenz können frei mit den Oberflächen der Aluminiumstrukturen kombiniert werden.

Disponibles en deux hauteurs et en six dimensions, les tables basses Tray se prêtent à la combinaison de différentes formes et matériaux. Caractérisés par un design essentiel, ils s'adaptent avec une extrême polyvalence aux besoins domestiques, de la zone jour à la zone nuit. Les plateaux en verre laqué, marbre et en noyer peuvent être combinés librement avec les finitions des structures en aluminium.

Disponibles en dos alturas y seis dimensiones, las mesitas Tray, se prestan a la combinación de materiales diferentes. Caracterizados por un design esencial, se adaptan con extrema versatilidad a las necesidades domésticas, del área living a la zona de noche. Las encimeras en cristal lacado, mármol y esencia de nogal de incrustación se pueden combinar libremente con los acabados de las estructuras en aluminio.

Struttura Structure: 31 alluminio lucido  
Top in marmo Marble top: 184 crystal gray  
W 1350 H 300 D 1350

Struttura Structure: 31 alluminio lucido  
Top Top: 15 noce  
W 650 H 220 D 650



Struttura *Structure*: 69 palladio  
 Top in marmo *Marble top*: 28 calacatta  
 W 1350 H 300 D 1350

Struttura *Structure*: 69 palladio  
 Top *Top*: 15 noce  
 W 650 H 220 D 650



Struttura *Structure*: 14 brown  
 Top *Top*: 99 caffè opaco  
 W 1350 H 300 D 1350

Struttura *Structure*: 14 brown  
 Top in marmo *Marble top*: 180 emperador  
 W 800 H 220 D 800



Design Giuseppe Bavuso

## Sixty coffee table

A system of coffee tables characterized by the particular design of the structural aluminium profile. The wide variety of dimensions and the free combination of aluminium finishes, glass and veneers of the collection, allows Sixty to be a versatile complement, suitable for domestic or professional environments.

Un sistema di tavoli bassi caratterizzato dal particolare disegno del profilo strutturale in alluminio. La varietà dimensionale e la libera combinazione tra le finiture dell'alluminio, dei vetri e delle essenze della collezione, rende Sixty un complemento versatile, adatto ad ambienti domestici o professionali.

Ein System niedriger Tische, das sich durch das besondere Design des Strukturprofils aus Aluminium auszeichnet. Die Massvielfalt und die freie Kombination der Aluminiumoberflächen, der Gläser und der Hölzer der Kollektion machen Sixty zu einer vielseitigen Ergänzung, die sich für den privaten oder professionellen Bereich eignet.

Un système de tables basses caractérisé par la conception particulière du profil structurel en aluminium. Les diverses dimensions disponibles et la combinaison libre des finitions de l'aluminium, des verres et des bois de la collection, permettent à Sixty de s'insérer dans différents lieux soit domestiques que professionnels.

Un sistema de mesas bajas caracterizado por el diseño particular del perfil estructural en aluminio. La variedad dimensional y la combinación libre de los acabados del aluminio de los vidrios y las esencias de la colección hacen de Sixty un complemento versátil, adecuado para entornos domésticos o profesionales.

Struttura *Structure*: 304 platino  
 Top *Top*: 15 Noce  
 Sottopiano *Lower top*: 75 amaranto lucido  
 W 1200 H 300 D 1200

Sixty coffee table →

Complements





Struttura *Structure*: 13 nero  
Top *Top*: 102 nero opaco  
W 800 H 300 D 800

Struttura *Structure*: 53 bianco neve  
Top *Top*: 95 bianco neve opaco  
W 440 H 450 D 440

Sixty coffee table ➤



Complements

Sixty coffee table ➤

Struttura *Structure*: 53 bianco neve  
Top *Top*: 95 bianco neve opaco



Design Giuseppe Bavuso

## Sixty

A bookcase with minimal aesthetics: essential lines characterized by the round connections between structure and shelves and by its exclusive invisible junctions. Available in numerous dimensional versions, the system provides the possibility of combining aluminium structure with glass tops, with contrasting finishes or with uniform colour, in the case of lacquered versions.

Una libreria dalla geometria essenziale, caratterizzata dal particolare raccordo fra la struttura e i piani, ottenuta grazie ad esclusive giunzioni a scomparsa. Disponibile in numerose varianti dimensionali, il sistema prevede la possibilità di abbinamento tra struttura in alluminio e piani in vetro, con finiture a contrasto o, nel caso delle versioni laccate, con colore uniforme.

Dies ist ein Bücherregal mit einer charakteristischen Geometrie, das sich durch die besondere Verbindung zwischen der Struktur und den Fachböden auszeichnet, die durch die verdeckten Fugen erhalten wird. Das System ist in vielen Maßen erhältlich und bietet die Möglichkeit der Kombination von Aluminiumrahmen und Glasfachböden, mit kontrastierenden Oberflächen oder, bei lackierten Ausführungen, in einheitlicher Farbe.

Une bibliothèque avec une géométrie essentielle, caractérisée par l'exceptionnelle connexion entre la structure et les étagères, obtenue grâce à des exclusifs joints cachés. Disponible dans de nombreuses versions dimensionnelles, le système offre la possibilité de combiner la structure en aluminium avec des étagères en verre, avec des finitions contrastantes ou, dans le cas des versions laquées, avec une couleur uniforme.

Una librería de geometría esencial, caracterizada por la conexión particular entre la estructura y los estantes, obtenida gracias a exclusivas juntas ocultas. Disponible en numerosas variaciones dimensionales, el sistema ofrece la posibilidad de combinar la estructura en aluminio con estantes en cristal, con acabados en contraste o, en el caso de las versiones lacadas, con color uniforme.

Struttura Structure: 300 rame  
Vetro Glass: 75 amaranto lucido  
W 440 H 1660 D 440

Nella foto *In this photo*  
Contentori sospesi  
*Suspended cabinets: Self*





Struttura *Structure*: 13 nero  
Vetro *Glass*: 46 nero lucido  
W 440 H 1660 D 440



Struttura *Structure*: 300 rame  
Vetro *Glass*: 75 amaranzo lucido



Design Giuseppe Bavuso

## Ala

Furniture sometimes exceeds functional limits and proposes new solutions to characterize the space, suitable to contain the most valuable objects. It is the aim of Ala cabinets, glass showcases designed as a precious box, that includes walnut veneered drawers characterized by the traditional "dove tail joint" manufacturing, and at the same time suspended on a totally concealed internal structure. A cabinet with a strong expressive value, conceived with a sophisticated technical intuition, that reveals a cabinet with a surprising aesthetic.

A volte gli arredi superano i limiti funzionali e si propongono come nuove soluzioni per caratterizzare lo spazio, ideali per contenere gli oggetti di maggiore affezione. È il caso dei contenitori Ala, vetrine concepite come uno scrigno prezioso, che schiude cassetti in essenza di noce caratterizzati dalla tradizionale costruzione "a coda di rondine" e sospesi su una struttura interna nascosta. Un mobile dal forte valore espressivo, concepito con una intuizione tecnica evoluta che si rivela in un mobile esteticamente sorprendente.

Manchmal überschreiten die Einrichtungsgegenstände die funktionalen Grenzen und werden als neue Lösungen vorgeschlagen, um dem Raum eine persönliche Note zu verleihen zur Verstauung wertvoller Objekte. Dies ist der Fall der Ala Behälter, die als Schatzkistenvitrinen entworfen wurden. Es gibt sie in der traditionellen Bauart der "Schwalbenschwanzverbindung" und aufgehängt an einer versteckten inneren Struktur. Es handelt sich um ein Möbelstück mit starkem Ausdruckswert, das mit einer fortgeschrittenen Technik konzipiert wurde, was sich wiederum in diesem ästhetisch auffälligen Möbelstück äußert.

Parfois, le meuble dépasse les limites fonctionnelles et sont proposées comme de nouvelles solutions pour caractériser l'espace, idéal pour contenir des objets d'une plus grande valeur. C'est le cas des conteneurs Ala, vitrines conçues comme un précieux coffret, qui ouvrent des tiroirs en noyer caractérisés par l'assemblage en "queue d'aronde" et suspendus sur une structure interne cachée. Un meuble à forte valeur expressive, conçu avec une intuition technique évoluée, qui se manifeste dans un meuble esthétiquement surprenant.

A veces los muebles exceden los límites funcionales y se proponen como nuevas soluciones para caracterizar el espacio, ideal para contener objetos de mayor afecto. Este es el caso de los contenedores Ala, vitrinas concebidas como un cofre precioso, que abre cajones en esencia de nogal ensamblados y suspendidos en una estructura interna oculta. Una pieza de mobiliario con un fuerte valor expresivo, concebida con una intuición técnica evolucionada que se revela en un mueble estéticamente sorprendente.

Struttura *Structure*: 303 bronzo  
 Top e schienale *Top and back panel*: 136 bronzo opaco  
 Ante *Doors*: 67 riflettente chiaro  
 Cassettiera *Drawer unit*: 15 noce  
 Rivestimento interno *Internal covering*: 153 similpelle castoro  
 W 557 H 1383 D 457

Nella foto *In this photo*  
 Porte scorrevoli *Sliding doors*: Sail  
 Tavolino *Coffee table*: Planet





Design Giuseppe Bavuso

## Dolmen

A double-sided display system available in various dimensions, designed for home settings as well as the walk-in closets or the public spaces. Realized in transparent glasses in the upper part and lacquered in the front. Dolmen combines drawers with push and pull opening and lacquered open modules.

Un sistema di contenitori-espositori bifacciale disponibile in varie dimensioni, destinato ad ambienti domestici come le cabine armadio o pubblici come spazi commerciali. Realizzato in vetro trasparente nella parte superiore e laccato nei frontali, Dolmen alterna cassetti con apertura push e vani a giorno laccati.

Ein zweiseitiges Ablagefach-Display-System, das in verschiedenen Größen erhältlich ist und für Wohnräume wie begehbare Kleiderschränke oder öffentliche Räume wie Geschäftsräume gedacht ist. Dolmen besteht aus transparentem Glas im oberen Teil und lackiert im vorderen Bereich und kombiniert abwechselnd Schubladen mit Drucköffnung und offene lackierte Fächer.

Un système de meubles exposés double face en différentes dimensions, destiné aux environnements domestiques comme les dressings ou les espaces commerciaux. Fabriqué en verre transparent dans la partie supérieure et laqué dans les façades, Dolmen propose tiroirs à ouverture push pull et compartiments ouverts laqués.

Dolmen es un sistema de contenedores expositores middle room ideado para adaptarse a una amplia variedad de situaciones, de los vestidores hasta los espacios comerciales. Hecho en cristal transparente en la parte superior y lacado en los frontales, Dolmen alterna cajones con abertura push y compartimentos abiertos lacados.

Struttura Structure: 30 alluminio  
Vetro Glass: 48 grigio ardesia lucido  
Vani a giorno Open modules: 40 grigio cenere  
Top, fianchi e divisorio  
Top, side panel and divider: 00 trasparente  
W 1944 H 839 D 942





Design Giuseppe Bavuso

## Eos

An innovative wall shelving system: in only 8 mm, the Eos design combines a lacquered glass top with a lacquered aluminium frame, blending aesthetic variety and maximum reliability. The wall fixing system, which ensures installation with no visible screws, includes a led lighting system.

Un sistema di mensole a parete dalle caratteristiche innovative: il progetto Eos riesce ad unire in soli 8 mm di spessore un top in vetro laccato con una struttura in alluminio laccato, coniugando varietà estetica e massima affidabilità. Il profilo di aggancio a parete, che garantisce un'installazione senza viti a vista, contiene il sistema di illuminazione a led.

Ein Wandregalsystem mit innovativen Merkmalen: Eos vereint mit lediglich 8 mm Dicke eine Decke aus lackiertem Glas mit einer lackierten Aluminium-Struktur und schafft es so Ästhetik und maximale Zuverlässigkeit zu kombinieren. Das Wandbefestigungsprofil, das eine Installation ohne sichtbare Schrauben garantiert, enthält ein Led-Beleuchtungssystem.

Un système d'étagères mural avec des caractéristiques innovantes: le projet Eos est capable de combiner en seulement 8 mm d'épaisseur un plateau en verre laqué avec une structure en aluminium laqué, combinant une variété esthétique et une fiabilité maximale. Le profil d'accrochage mural, qui garantit une installation sans vis apparentes, contient le système d'éclairage led.

Un sistema de estantes a pared de las características innovadoras: el proyecto Eos combina en solo 8 mm de espesor un top en cristal lacado con una estructura en aluminio lacado, combinando variedad estética y máxima confiabilidad. El perfil de fijación a la pared, que garantiza una instalación sin tornillos visibles, contiene el sistema de iluminación por leds.

La straordinaria leggerezza, la presenza della luce e la ricercatezza delle finiture dell'alluminio e dei vetri della collezione Rimadesio, rendono le mensole Eos una soluzione d'arredo semplice, ma di grande valore estetico. Eos è disponibile in 13 larghezze standard, con inoltre la possibilità di riduzione a misura.

The extraordinary lightness, the presence of light, and the refinement of the finish of aluminium and glass in the Rimadesio collection, make the Eos shelves a simple solution, but with high aesthetic value. Available in 13 standard widths that can be also reduced.

Die einzigartige Leichtigkeit, das Vorhandensein der Beleuchtung und die Gewähltheit den Ausführungen des Aluminiums und der Gläser der Kollektion Rimadesio machen die Regalboden Eos zu einer wertvollen aber einfachen Wohnlösung. Eos ist in 13 verschiedenen Standard Breiten mit der Möglichkeit der Kürzung in Breite.

La légèreté extraordinaire, la présence de la lumière et la recherche des finitions de l'aluminium et des verres de la collection Rimadesio font des étagères Eos une solution d'intérieur simple mais d'une grande valeur esthétique. Disponible en 13 largeurs standard avec possibilité de réduction sur mesure.

La extraordinaria ligereza, la presencia de la luz y el refinamiento del acabado del aluminio y de los cristales de la colección Rimadesio, hacen de los estantes Eos una solución de amueblamiento sencilla, pero de gran valor estético. Disponible en 13 anchuras standard, además con posibilidad de reducción a medida.



**Dimensioni complementi**  
**Complements dimensions**

**Flat**

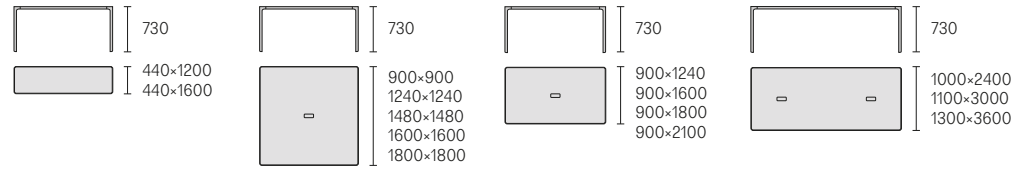

**Long Island**

Versione con top in vetro laccato e legno  
Lacquered glass top and wooden top version

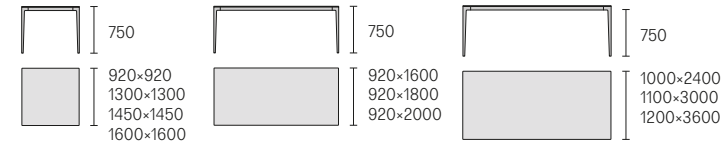

Versione con top in vetro trasparente grigio  
Gray transparent glass top version

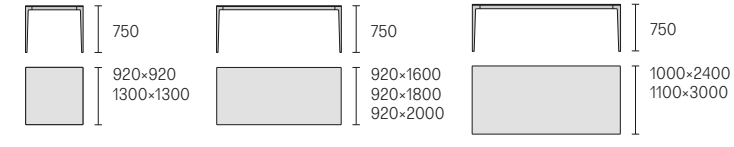

Versione con top in marmo / Marble top version

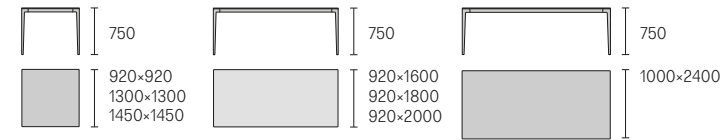

Versione allungabile con top in vetro laccato o legno  
Wooden and lacquered glass top extensible version

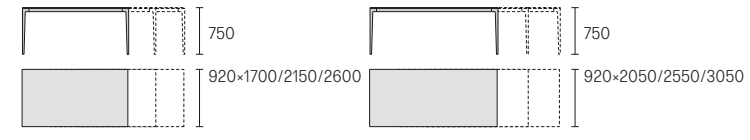

**Manta**

Versione con top in legno, vetro laccato e vetro trasparente  
Wooden, lacquered or transparent glass top version

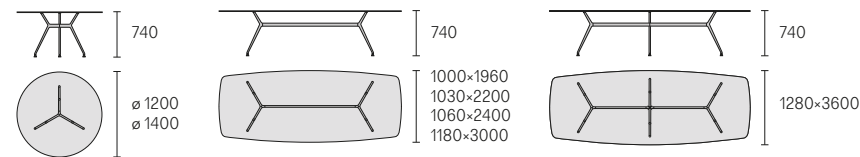

Versione con top in marmo  
Marble top version

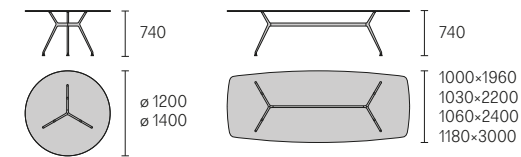

Versione con top in legno e piano girevole opzionale  
Wooden top version and optional lazy susan

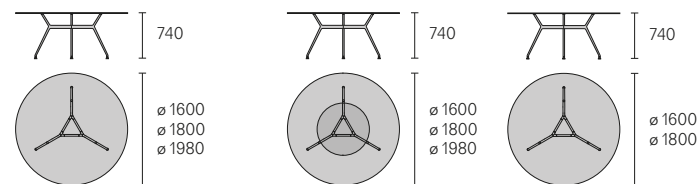

Versione con top in vetro laccato e trasparente  
Lacquered and transparent glass top version

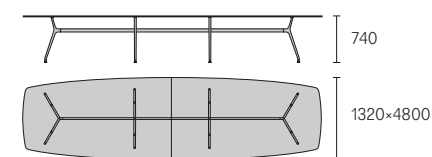

Versione con top in legno  
Wooden top version

**Planet**

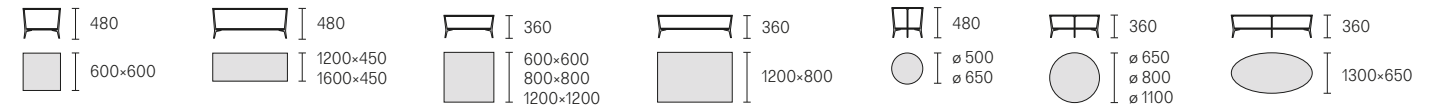

**Tray**

Versione con top in vetro H 6 mm  
Glass top H 6 mm version

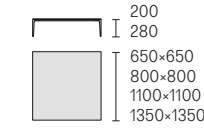

Versione con top in legno H 25 mm  
Wooden top H 25 mm version

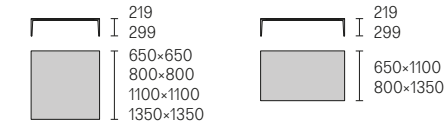

Versione con top in marmo H 15 mm  
Marble top H 15 mm version

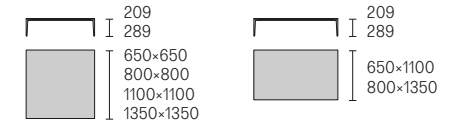

**Sixty coffee table**

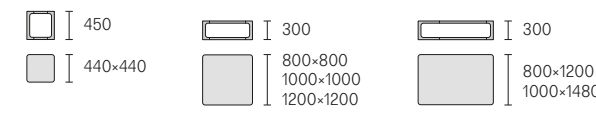

**Sixty**

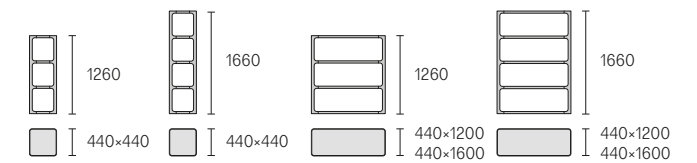

**Dolmen**

**Fronte / Front**

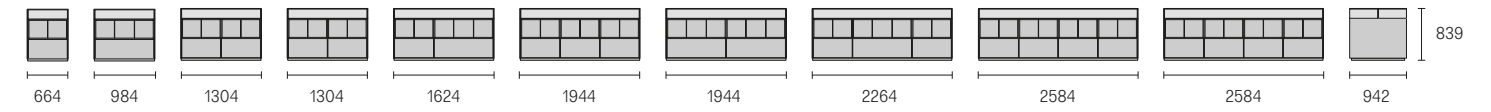

**Retro / Back**

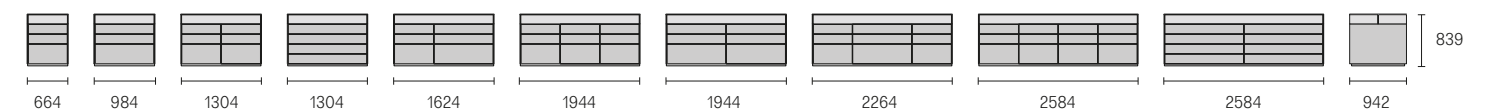

**Ala**

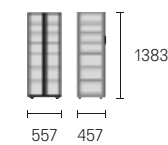

**Eos**

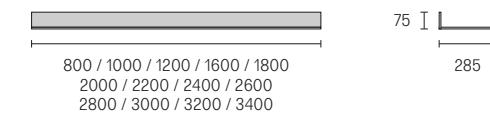



# Night collection

451 Dress bold, 467 Zenit, 479 Abacus



Design Giuseppe Bavuso

## Dress bold

Dress bold is a system that creates highly personalized walk-in closets with the option of customized compositions for linear, corner and C-shaped solutions. Two aesthetic possibilities: with visible uprights or with back panels available in glossy or mat glass, fabric, wood, mirror and provided with optional upper led lighting.

The accessories, which can be freely placed along the wall upright by means of a patented expansion fixing system that requires no holes, include: shelves and floor bases, cloth hangers, cloth lift, drawer units, trouser racks and pull out trays.

Dress bold è un sistema per creare cabine armadio personalizzabili al massimo grado, con possibilità di composizioni su misura in soluzioni lineari, ad angolo e a C. Due le possibilità estetiche: con i montanti a vista o con pannelli a parete, disponibili in vetro laccato lucido o opaco, tessuto, similpelle, legno, specchio, e dotati di illuminazione a led superiore opzionale. Gli accessori, liberamente posizionabili lungo il montante a parete, grazie al sistema brevettato di fissaggio ad espansione senza fori, comprendono: mensole e basamenti, aste portabiti, appendiabiti inclinabile, cassettiere, portapantaloni e vassoi estraibili.

Das System Dress bold wurde für Schrankzimmer mit maximaler individueller Gestaltbarkeit entwickelt und bietet maßgeschneiderte Kombinationsmöglichkeiten für Lösungen in Reihen-, Eck- oder C-Anordnung. Hier sind zwei Gestaltungsmöglichkeiten gezeigt: entweder mit sichtbaren Pfosten oder mit Wandpaneelen, erhältlich in glänzendem oder mattem Glas, Kunstleder, aus Holz, aus Spiegel und optional mit oberer Led-Beleuchtung. Das umfangreiche Zubehör lässt sich dank eines patentierten Spreizbefestigungssystems ohne Bohrungen beliebig am Wandträger anbringen und besteht aus: Regalböden und Sockelelementen, Kleiderstangen, Kleiderlift, Schubladen, Hosenhaltern und Ablageflächen in ausziehbarer Ausführung.

Dress bold est un système pour créer des dressings personnalisables avec une possibilité de compositions sur mesure en solutions linéaires, d'angle ou en forme de C. Les deux possibilités esthétiques: avec montants visibles ou avec des panneaux de fond, disponibles en verre laqué brillant ou mat, tissu, similcuir, bois, miroir, et équipés avec système d'éclairage led supérieur optionnel. Les accessoires, positionnables librement sur le montant au mur, grâce au système breveté de fixation à expansion sans trous, comprennent: étagères et bases au sol, barres penderies, porte-manteaux inclinable, blocs tiroirs, porte-pantalons et plateaux extractible.

Dress bold es un sistema para crear vestidores personalizables de alto nivel, con posibilidad de efectuar composiciones a medida mediante soluciones lineares, angulares y en forma de C. Ambas posibilidades estéticas: con montantes visibles o con paneles de pared, disponibles en vidrio lacado brillante o mate, tejido, simil cuero, madera, espejo, y equipada con iluminación Led superior opcional. Los accesorios, que pueden colocarse libremente a lo largo del montante de pared, gracias al sistema patentado de fijación por expansión sin orificios, incluyen: estantes y bases, barras de colgar, barra de colgar reclinable, cajoneras, portapantalones y bandejas extraíbles.

Struttura Structure: 303 bronzo  
 Schienali in tessuto Fabric back panels: T042 ruggine  
 Basamento, ripiani e contenitori  
 Floor base, shelves and cabinets: 07 melanimico olmo  
 Aste portabiti e ripiani portascarpe  
 Clothes hanging bars and shoe rack shelves:  
 153 similpelle castoro  
 Ripiani e pannelli a parete con sistema di illuminazione led integrato  
 Shelves and back panels with integrated led lighting system

Nella foto In this photo  
 Pannelli scorrevoli  
 Sliding doors: Velaria



Struttura Structure: 303 bronzo  
 Schienali in tessuto Back panels fabric: T042 ruggine  
 Basamento, ripiani e contenitori  
 Floor base, shelves and cabinets: 07 melanimico olmo  
 Aste portabiti e ripiani portascarpe  
 Clothes hanging bars and shoe rack shelves: 153 similpelle castoro  
 Ripiani e pannelli a parete con sistema di illuminazione led integrato  
 Shelves and back panels with integrated led lightning system

Nella foto In this photo  
 Pannelli scorrevoli Sliding doors:  
 Velaria Settimanale  
 Drawer unit: Self Bold  
 Tavolino Coffee table: Planet  
 Porta Door: Moon







Un livello di illuminazione ideale, una personalizzazione dell'intensità luminosa e delle qualità della luce grazie all'utilizzo di sorgenti a led che possono essere posizionate sotto il basamento a terra, sotto la mensola e sotto i ripiani portascarpe, oppure nella parte superiore dello schienale con struttura in alluminio, disponibile in tessuto, similpelle, legno, vetro laccato e specchio. Il ripiano portascarpe inclinato è dotato di un innesto rapido ed invisibile, senza viti né giunzioni a vista per una pulizia estetica assoluta.

An ideal level of lighting, a customized light intensity and light quality, thanks to the use of led sources, which can be positioned under the floor base, the shelf and the shoe shelves, or in the upper part of the back panel with aluminium frame, available in fabric, synthetic leather, wood, lacquered glass and mirror. The sloping shoe shelf is equipped with a fast and invisible fixing device, without visible screws or joints for an extreme clean aesthetic.

Ein optimales Beleuchtung Niveau, Personalisierung der Lichtintensität und Qualität, dankte zu Led Energiequellen, die entweder unten Bodenbasis, Fachboden, Schuetraeger sich positionieren koennen, oder bei obener Seite der Rueckwand, die aus Stoffe, Kunstleder, Holz, lackiertem Glas oder Spiegel erhaltbar ist. Der gekippter Schuetraeger ist mit rapider und unsiehbbarer Einrueckung ausgestattet, ohne siehbaren Schrauben, um eine absolute aesthetische Sauberkeit zu erreichen.

Un niveau idéal d'illumination, une personnalisation de l'intensité lumineuse et de la qualité de la lumière, grâce à l'utilisation de sources à led, qui peuvent être placés sous la base au sol, sous l'étagère et sous l'étagère porte chaussure, soit dans la partie supérieure du panneau de fond avec structure en aluminium, disponible en tissu, cuir synthétique, bois, verre laqué et miroir. L'étagère porte chaussure incliné est disponible avec une fixation rapide et invisible, sans vis ni joints visibles pour une esthétique propre.

Un nivel de iluminación ideal, una personalización de intensidad luminosa y de las calidades de la luz gracias a la utilización de fuentes de led que pueden ser colocadas debajo de la base en el suelo, debajo de estante y por debajo de los zapateros, o en la parte superior de la trasera con estructura en aluminio, disponible en tejido, simil cuero, madera, vidrio lacado y espejo. El estante zapatero inclinado está equipado con un injerto rápido y invisible, sin tornillos y sin juntas a la vista para una limpieza estética absoluta.



Struttura Structure: 83 piombo  
Schienali in tessuto Fabric back panels: T019 papiro  
Basamento, ripiani e cassettiere  
Floor base, shelves and drawer units: 09 melanimico rovere grigio  
Aste portabiti e accessori estraibili  
Cloth-hanger rods and pull out accessories: 154 similpelle argilla



## Modularità Modular structure

Versione con montante a parete  
Version with wall uprights

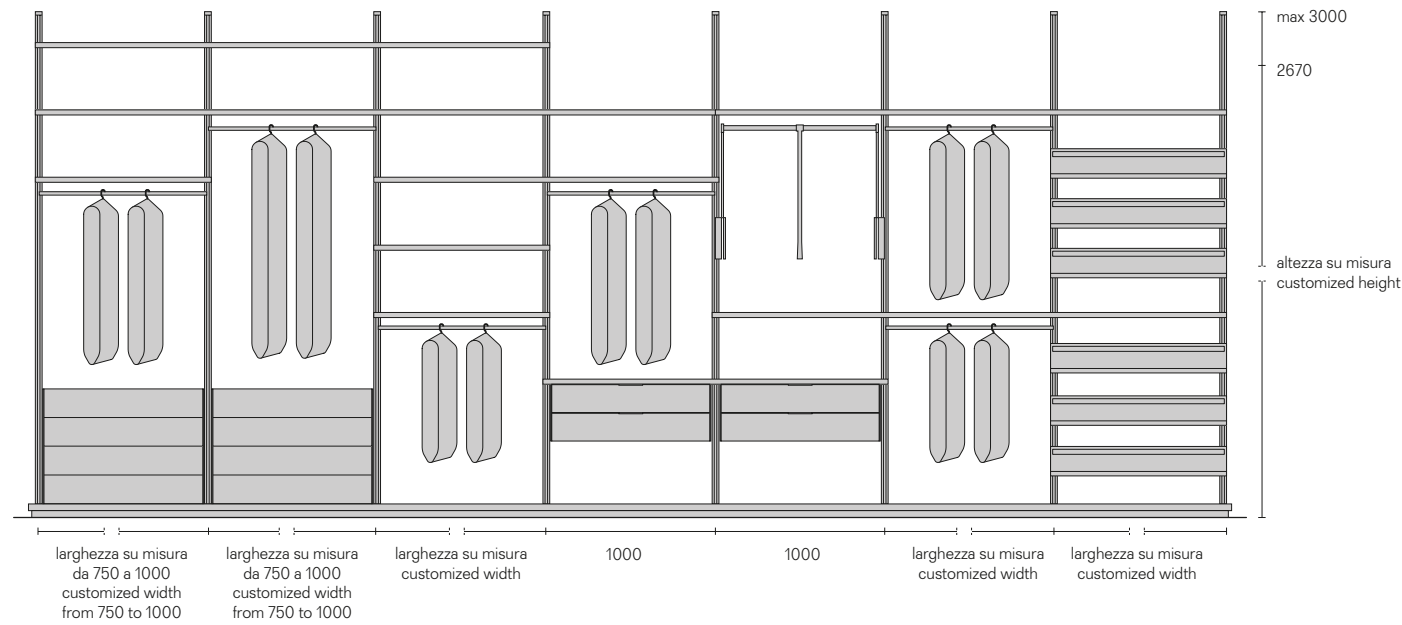

Versione con montante a parete e schienali in tessuto, similpelle, melaminico, vetro laccato e specchio  
Version with wall uprights and back panels in fabric, synthetic leather, melamine, lacquered glass and mirror

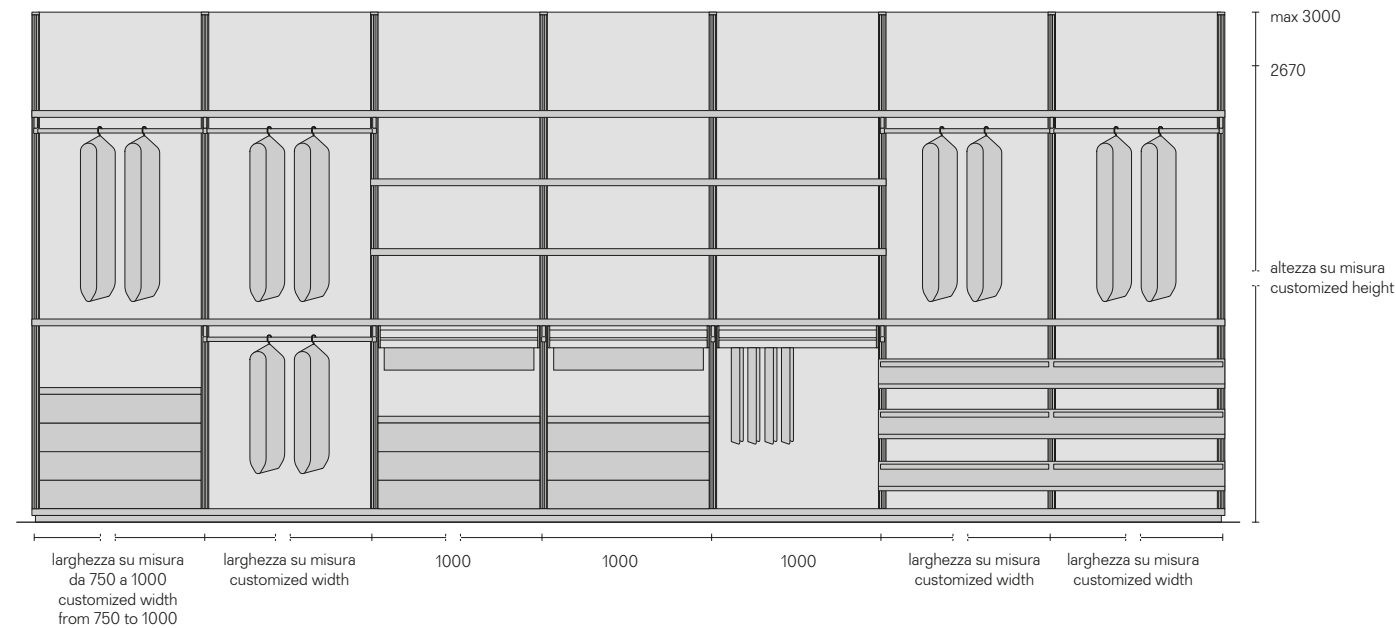

### Descrizione tecnica Technical description

Un sistema per creare cabine armadio personalizzabili, con possibilità di composizioni su misura in soluzioni lineari, ad angolo e a C. Due le possibilità estetiche: con i montanti a vista o con pannelli a parete, disponibili in vetro laccato, specchio, melaminico, tessuto e similpelle. Gli accessori sono liberamente posizionabili lungo il montante a parete, grazie al sistema brevettato di fissaggio ad espansione senza fori.

A system which allows to personalize walk-in closets with custom-made linear, as well as corner and C-shaped compositions. Two aesthetical possibilities are available: with visible uprights or with wall back panels, available in lacquered glass, wood, fabric and synthetic leather. The accessories can be freely positioned on the wall upright, thanks to the patented expansion fixing system, without holes.

Das System erlaubt, persönliche Schrankräume mit lineare sowohl als Ecke Lösungen, immer nach Mass, zugestalten. Zwei sind die vefuegbare aesthetische Moeglichkeiten: mit sichtbaren Wandpfosten oder mit Wandpaneelen, aus lackiertem Glas, Holz und mit Stoff und Kunstleder. Die Zubehoeren koennen frei auf den Pfosten mit dem patentierten Spreizmechanismus ohne Loecher gestellt werden.

Dress bold est le système pour personnaliser au mieux les dressings avec des compositions linéaires ou à angle, toujours sur mesure. Deux sont les possibilités esthétiques: avec les montants à vue ou avec les panneaux murales de fond, disponibles en verre laqué, bois, tissu et cuir synthétique. Les accessoires sont librement positionnables sur le montant mural grâce au système breveté de fixation à expansion sans trous.

Dress bold es un sistema para realizar vestidores personalizable al máximo grado, con la posibilidad de composiciones a medida en soluciones lineales, ángulares y a C. Las posibilidades estéticas son dos: con montantes a vista o con paneles a pared, disponibles en cristal lacado, en madera, tejido y similcuer. Los accesorios son libremente posicionables en los montantes a pared, gracias al sistema patentado de fijación a expansión sin agujeros.

## Dettagli tecnici esclusivi Exclusive technical details



1.



2.



3.

### Le tipologie estetiche Aesthetical typologies



1.



2.



3.



4.

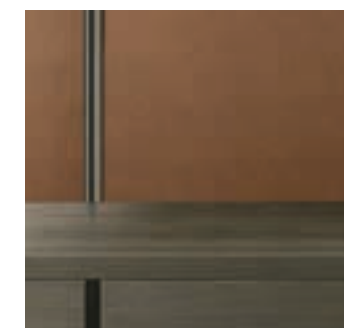

5.

- Particolare del pannello a parete in tessuto papiro con sistema di illuminazione a led nel lato superiore, ripiano in melaminico rovere grigio con illuminazione a led integrata. Montante e reggimensola in alluminio piombo, asta portabiti rivestita in similpelle argilla. Detail of back panel in papiro fabric with upper led lighting system, grey oak melamine shelf with integrated led lighting. Upright and shelf holder in piombo lacquered aluminium, cloth-hanger rod covered with synthetic leather argilla.
- Basamento in similpelle, profilo perimetrale e zoccolo in alluminio piombo. Illuminazione a led opzionale. Floor base in synthetic leather with extruded aluminium. back and perimetric profile. Optional led lighting.
- Ripiano portascarpe in similpelle argilla, profilo perimetrale e posteriore in alluminio piombo. Tondini di appoggio in acciaio inox. Illuminazione a led opzionale. Shoe rack in synthetic leather with extruded aluminium back and perimetric profile. Optional led lighting.

## Componenti Components

Montante a parete. Profilo elettrificato opzionale per cablaggio ripiani e basamenti / Wall upright. Optional electrified upright for shelves and floor base wiring

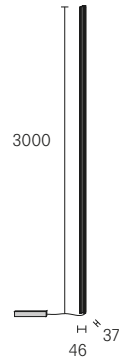

Pannello in melaminico, in tessuto o in similpelle / Melamine, fabric or synthetic leather panel

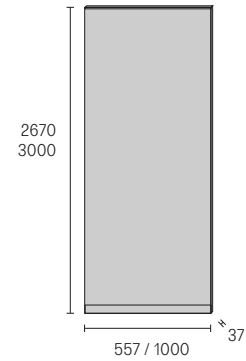

Pannello in vetro laccato o specchio  
Panel in lacquered glass or mirror

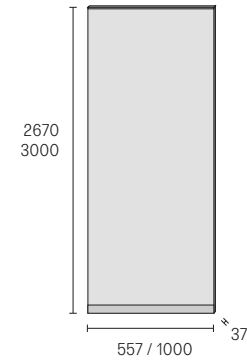

Illuminazione a led superiore per pannello, 3200° Kelvin (luce calda)  
Upper led lighting system for glass back panel, 3200° Kelvin (warm light)

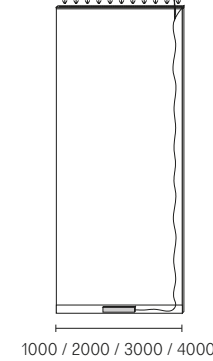

Ripiano in similpelle, profilo perimetrale in estruso di alluminio. Illuminazione a led opzionale / Shelf in synthetic leather with extruded aluminium perimetric profile. Optional led lighting

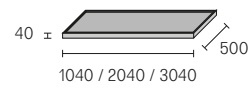

Ripiano in melaminico. Illuminazione a led opzionale / Shelf in melamine. Optional led lighting

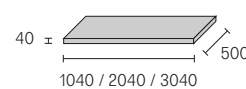

Reggimensola, reggiasta e asta portabiti in alluminio con rivestimento opzionale in similpelle / Supporting shelf, cloth hanger in aluminium with optional covering in synthetic leather

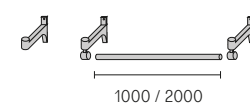

Basamento in similpelle, profilo perimetrale e zoccolo in estruso di alluminio. Illuminazione a led opzionale  
Floor base in synthetic leather with extruded aluminium back and perimetric profile. Optional led lighting

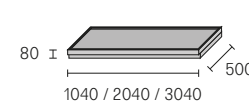

Basamento in melaminico con zoccolo in alluminio estruso. Illuminazione a led opzionale / Base on feet melamine floor with structure in aluminium. Optional led lighting

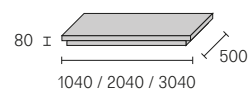

Ripiano portascarpe in similpelle, profilo perimetrale e posteriore in estruso di alluminio. Tondini di appoggio in acciaio inox. Illuminazione a led opzionale / Shoe rack in synthetic leather with extruded aluminium back and perimetric profile. Optional led lighting

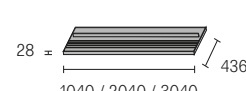

Ripiano portascarpe in melaminico. Illuminazione a led opzionale  
Melamine shoe rack. Optional led lighting

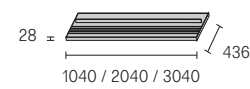

Illuminazione a led 3200° Kelvin (luce calda) per ripiani, basamenti e ripiani portascarpe / Led lighting system, 3200° Kelvin (warm light), for shelves, floor bases and shoe rack

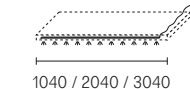

Reggimensola inclinato per ripiano portascarpe / Inclined shelf holder for shoe rack



## Componenti interni Interior components

Cassettiera per basamento e su ruote in melaminico con quattro cassetti  
Drawer unit on floor base and on wheels in melamine with four drawers

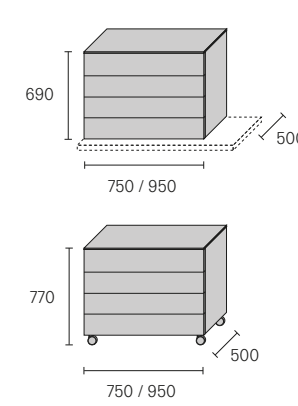

Cassettiera per basamento e su ruote in melaminico larice carbone con tre cassetti / Drawer unit on floor base and on wheels in coal larch melamine with three drawers

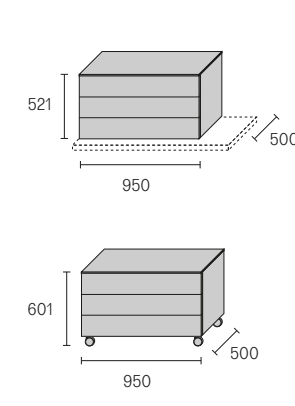

Top opzionale in melaminico larice carbone con fondo rivestito in similpelle, per cassettera su basamento o su ruote / Optional top in coal larch melamine with bottom part covered with synthetic leather, for drawer units on floor base or on wheels

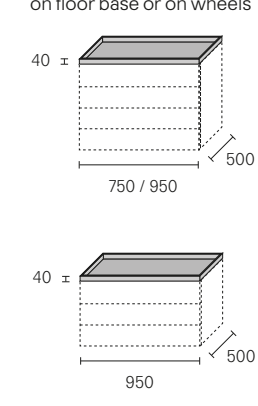

Cassettiera sospesa in melaminico  
Suspended drawer unit in melamine

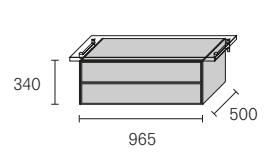

Tovaglietta opzionale in similpelle per fondo cassetti / Optional synthetic leather mat for drawer bottom



Ripiano con organizer e cesto basso estraibili con frontali in vetro e rivestimento in similpelle / Pull out shelf with organizer and small tray with glass fronts and covered with synthetic leather

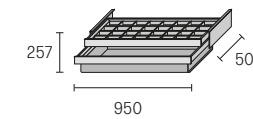

Ripiano con organizer e cesto alto estraibili con frontali in vetro e rivestimento in similpelle / Pull out shelf with organizer and big tray with glass fronts and covered with synthetic leather

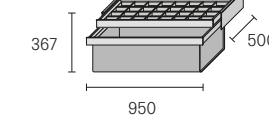

Ripiano e cesto basso estraibili con frontali in vetro e rivestimento in similpelle  
Pull out shelf and small tray with glass fronts and covered with synthetic leather

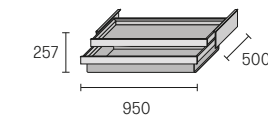

Ripiano e cesto alto estraibili con frontali in vetro e rivestimento in similpelle  
Pull out shelf and big tray with glass fronts and covered with synthetic leather

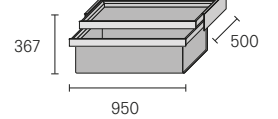

Ripiano in vetro e portapantaloni in alluminio estraibili / Pull out glass shelf and aluminium trousers rack

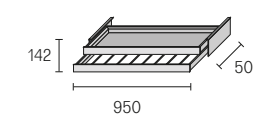

Ripiano e portapantaloni estraibili con frontali in vetro e rivestimento in similpelle / Pull out shelf and trousers rack with glass fronts and covered with synthetic leather

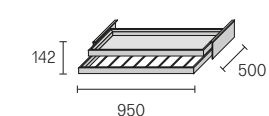

Ripiano con organizer e portapantaloni estraibili con frontali in vetro e rivestimento in similpelle / Pull out shelf with organizer and trousers rack with glass fronts and covered with synthetic leather

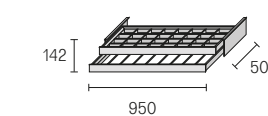

Appendiabiti inclinabile telescopico  
Telescopic cloth lift

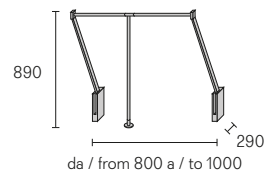



Design Giuseppe Bavuso

## Zenit

The walk-in closet defined by lightness and compositional versatility. The uprights, always custom made in height from floor to ceiling, allow a free positioning of the accessories, both in number and height. The finishings available provide two aesthetic possibilities: a version with glass shelves and drawer units in mat or glossy lacquered glass to discover the great variety of the exclusive 70 Ecoloursystem colours, and, as an alternative, the version with accessories in melamine coal larch, grey oak or elm.

La cabina armadio all'insegna della leggerezza e della versatilità compositiva. I montanti, sempre su misura da terra a soffitto, permettono una libera disposizione delle attrezzature, nel numero e all'altezza desiderata. Le finiture previste invitano a due possibili interpretazioni estetiche: la versione con ripiani in vetro e cassettiere in vetro laccato lucido e opaco che permette di esplorare l'eccezionale varietà dei 70 colori esclusivi Ecoloursystem e, in alternativa, la versione con attrezzatura in melaminico larice carbone, rovere grigio o olmo.

Der begehbare Kleiderschrank definiert sich durch Leichtigkeit und kompositorische Vielseitigkeit. Die vertikalen Pfosten, werden immer auf Maß in der Höhe vom Boden bis zur Decke gefertigt und erlauben eine freie Platzierung den Zubehören, sowohl in der gewünschten Anzahl als auch Höhe. Für das Zubehör stehen Varianten mit Glasregalen und Schubladeneinheiten aus mattem oder glänzend lackiertem Glas in den 70 exklusiven Farben unseres Ecoloursystems zur Verfügung und alternativ auch Versionen in unseren drei Melamin Aus-führungen Kohllärche, Eiche grau und Ulme.

Le dressing est défini par la légèreté et la polyvalence de la composition. Les montants toujours sur mesure en hauteur, fixés du sol au plafond, permettent une disposition libre de l'équipement, dans le nombre et à la hauteur désirées. Les finitions disponibles offrent deux possibilités esthétiques: une version avec des étagères en verre et les tiroirs en verre laqué mat ou brillant pour découvrir la grande variété des 70 couleurs exclusives Ecoloursystem, et, comme alternative, la version avec des accessoires en mélamine mélèze carbon, chêne gris ou orme.

El vestidor definido por la ligereza y la versatilidad compositiva. Los montantes, siempre hechos a medida en altura de suelo a techo, permita una colocación libre de los accesorios, tanto en número como en altura. Los acabados disponibles ofrecen dos posibilidades estéticas: una versión con estantes de vidrio y cajoneras en mate o cristal lacado brillante para descubrir la gran variedad de los exclusivos 70 colores Ecoloursystem, y, como alternativa, la versión con accesorios en melamina alerce carbón, gris roble y olmo.

Struttura Structure: 14 brown  
 Accessori Accessories: 153 similpelle castoro  
 Ripiani Shelves: 25 melaminico larice carbone

Nella foto In this photo  
 Porte scorrevoli Sliding doors: Velaria

Night collection





Struttura *Structure*: 13 nero  
 Ripiani *Shelves*: 63 grigio trasparente  
 Cassettiere in vetro *Glass drawers*: 102 nero opaco  
 Cesti *Baskets*: 154 similpelle argilla

Zenit ➤

Nella foto *In this photo*  
 Tavolino *Coffee table*: Planet  
 Pannelli scorrevoli *Sliding doors*: Stripe



Struttura *Structure*: 13 nero  
 Ripiani *Shelves*: 63 grigio trasparente  
 Cassettiere in vetro *Glass drawers*: 102 nero opaco

Night collection

Zenit ➤

La cabina armadio Zenit amplia le proprie potenzialità progettuali con l'introduzione delle nuove attrezzature in similpelle. La gamma degli accessori, che come tutti gli elementi compositivi di Zenit consentono un libero posizionamento, comprende: barra portabiti, ripiani estraibili con organizer o vaschetta, cesti alti e bassi, portapantaloni, portacravatte e portascarpe.

Zenit walk-in closet widens its design potential with new accessories in synthetic leather. The range of accessories, which allow a free positioning, like all the other elements for Zenit, includes: cloth hangers, pull out shelves with organizer or trays, big or small trays, trousers racks, tie racks and shoe racks.

Zenit Ankleide erweitert Planungsmöglichkeiten, dank der Einführung der neuen Zubehöer aus Kunstleder. Die komplette Bandbreite der neuen Ausstattung kann, wie die bestehende Ausstattung, frei positioniert werden. Es besteht aus: Kleiderstangen, Auszugsböden, Organizer, Wannen, niedrige und hohe Körbe, Hose, Krawatte und Schuhregale.

Le dressing Zenit permet aussi de faire de compositions avec un nouvel équipement en similicuir. La gamme d'accessoires, qui, comme tous les éléments de la composition de Zenit permettent un positionnement libre, comprend: les tiges, plateaux amovibles avec organizer ou vide poches, conteneurs hauts et bas, porte-pantalons, porte-cravates et porte-chaussures.

El vestidor Zenit amplia sus capacidades de diseño con la introducción de los nuevos equipos en simil cuero. La gama de accesorios, que al igual que todos los elementos compositivos de Zenit permiten un posicionamiento libre, incluye: barras de colgar, estantes extraíbles con organizadores o bandejas, cestas altas y bajas, pantaloneros, corbateros y zapateros.



Struttura *Structure*: 14 brown  
Ripiani *Shelves*: 25 melaminico larice carbone  
Contenitore *Organizer*: 15 noce  
Separatore doppio, porta orologi, vaschetta concava,  
vaschetta con fessure in synthetic leather 153 castoro  
*Double partition, watch holder, concave box and box with  
jewels slots available in synthetic leather 153 castoro*



**Modularità**  
**Modular structure**

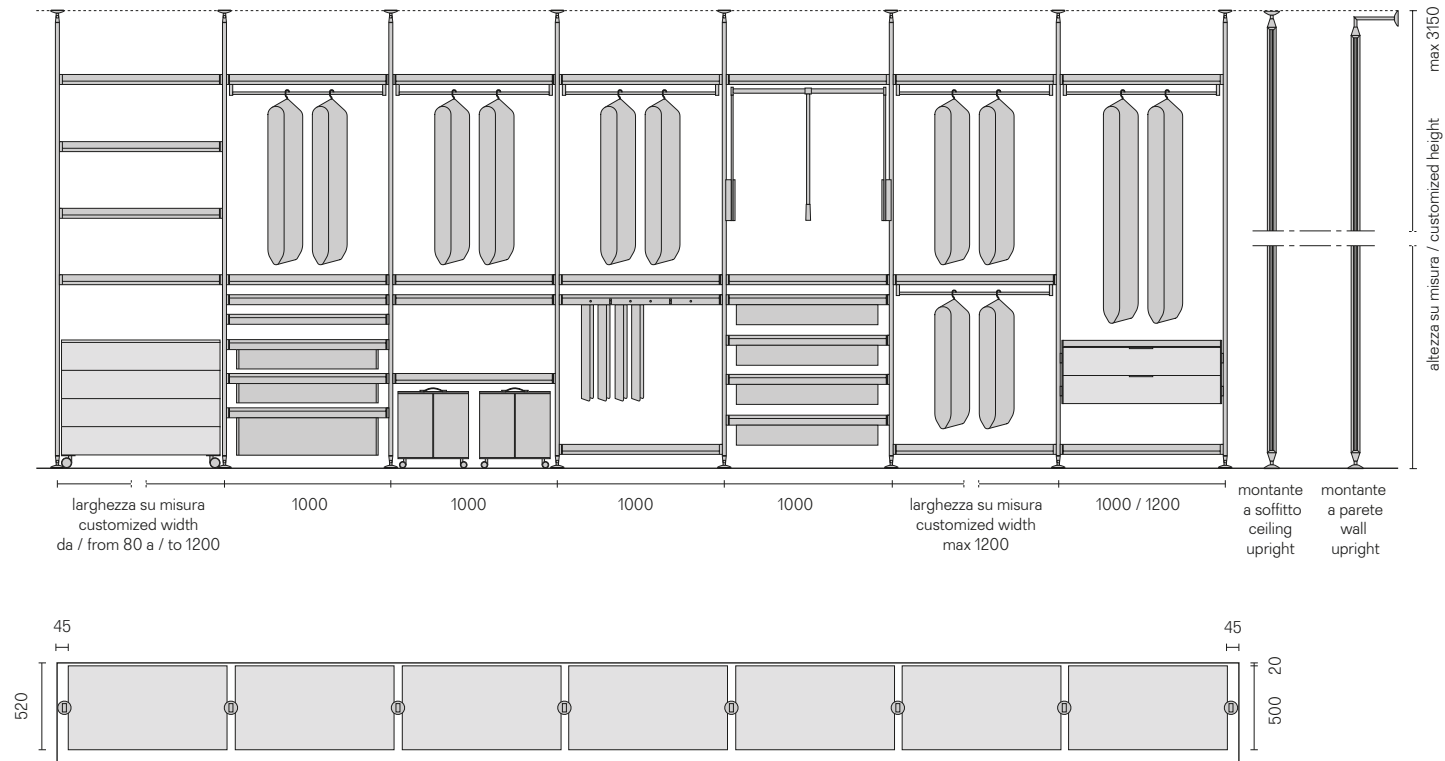

**Descrizione tecnica**  
**Technical description**

Le composizioni Zenit vengono sempre realizzate su misura in altezza, con possibilità di montanti a parete o a soffitto. Le mensole e le barre portabiti sono disponibili in tre larghezze, con inoltre la possibilità di riduzione a misura. Tutti gli altri componenti sono disponibili solo nella larghezza indicata.

Zenit compositions are always custom-made in height, with wall or ceiling uprights. Shelves and cloth hangers are available with three widths, with the possibility to reduce them. All the other elements are available only with the indicated width.

Zenit Anlage sind immer nach Mass in Hoehe, mit Wand oder Decke-Pfosten hergestellt. Fachboeden und Kleiderstange sind mit drei Breiten verfuegbar. Es ist auch moeglich sie nach Mass zu kuerzen. Die andere Zubehoeren sind nur mit der angegebenen Breite verfuegbar.

Les compositions Zenit sont toujours sur mesure en hauteur, avec les montants à fixation murale ou au plafond. Les étagères et les tiges porte-manteaux sont disponibles en trois largeurs avec la possibilité de les réduire sur mesure. Tous les autres accessoires sont disponibles seulement dans la dimension indiquée.

Las composiciones Zenit están siempre realizadas a medida en altura, con posibilidad de montantes a pared o a techo. Los estantes y las barras de colgar están disponibles en tres anchuras, con la posibilidad de reducción a medida. Los otros accesorios están disponibles sólo en la anchura indicada.

**Finiture**  
**Finishes**

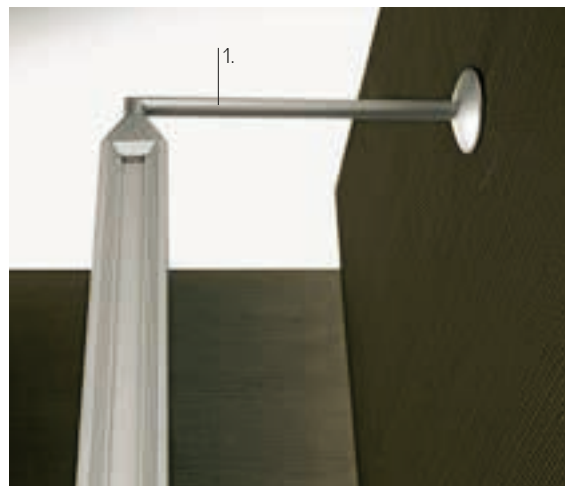

1. Il montante a parete in acciaio. / Wall upright in steel.
2. Mensola con ring perimetrale in estruso d'alluminio anodizzato. / Shelf with perimetrical ring in extruded aluminium.
3. Aggancio a baionetta tra mensola e staffa di sostegno in pressofusione. / Bayonet fixing between the shelf and the die casting support.
4. Montante strutturale in estruso d'alluminio anodizzato. Structural upright in extruded aluminium.
5. Staffa di sostegno con fissaggio ad espansione brevettato per permette di riposizionare gli accessori. Support with expansion fixing system which allows to adjust the position of the accessories.

**Componenti**  
**Components**

Mensola in vetro temperato o melaminico con ring in alluminio, disponibile anche con barra portabiti inferiore con rivestimento in similpelle opzionale / Tempered glass or melamine shelf with aluminium ring, Available also with lower cloth hanger, with optional synthetic leather covering

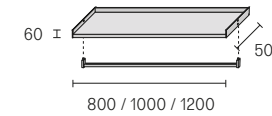

Mensola angolare in vetro temperato o melaminico con ring in alluminio, disponibile anche con barra portabiti inferiore con rivestimento in similpelle opzionale / Tempered glass or melamine corner shelf with aluminium ring, available also with integrated cloth stand rod with optional synthetic leather covering

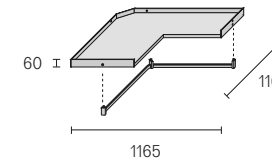

Barra portabiti singola e singola angolare con rivestimento in similpelle opzionale / Single and corner single cloth hanger with optional synthetic leather covering

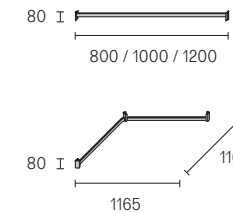

Appendiabiti inclinabile telescopico / Telescopic cloth lift

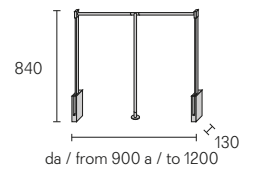

Cassettiera sospesa in melaminico o in vetro laccato e temperato con ring in alluminio / Suspended melamine or lacquered and tempered glass drawer unit with aluminium ring

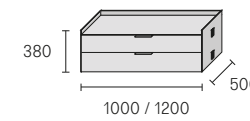

Cassettiera su ruote in vetro laccato o in melaminico con quattro cassetti / Drawer unit on wheels in lacquered glass or in melamine with four drawers

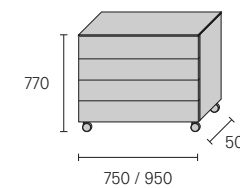

Cassettiera su ruote in melaminico larice carbone con tre cassetti / Drawer unit on wheels in coal larch melamine with three drawers

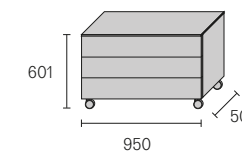

Top opzionale in melaminico larice carbone con fondo rivestito in similpelle, per cassetteria su ruote / Coal larch melamine optional top with bottom part covered with synthetic leather, for drawer units on wheels

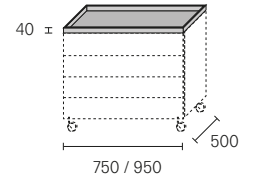

Tovaglietta opzionale in similpelle per fondo cassetti / Optional synthetic leather mat for drawer bottom



Ripiano estraibile con organizer in similpelle / Pull out shelf with organizer tray in synthetic leather finishing

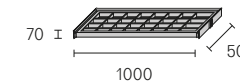

Cesti basso e alto estraibili in similpelle / Pull out small and big trays in synthetic leather finishing

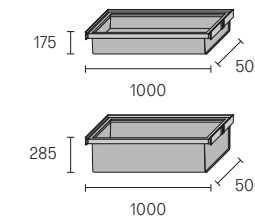

Contenitore su ruote in similpelle, interno in tessuto nero / Cabinets on wheels in synthetic leather finishing, black fabric inside

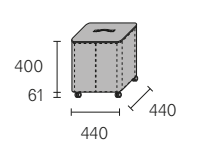

Ripiano estraibile con portapantaloni e vani per cinture in similpelle / Pull out shelf with trousers rack and belts tray in synthetic leather finishing

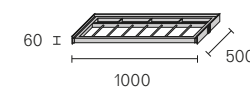

Ripiano estraibile portacravatte in similpelle / Pull out shelf with tie rack in synthetic leather finishing

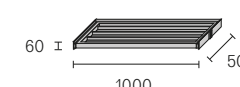

Ripiano estraibile portascarpe in similpelle / Pull out shelf with shoe rack in synthetic leather finishing

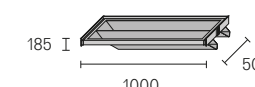

Cesta e vassoio in similpelle / synthetic leather box and tray

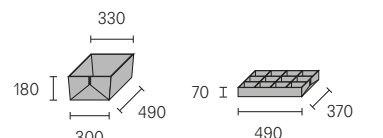

Ripiano estraibile con vaschetta in similpelle / Pull out shelf with tray in synthetic leather finishing

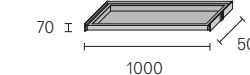

Contenitore in essenza di noce / Walnut veneered organizer

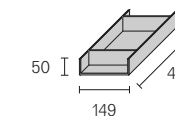

Separatore doppio / Organizer with double partition

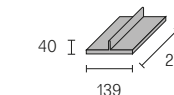

Porta orologi / Watch holder

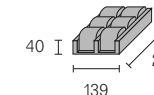

Vaschetta con fessure e vaschetta concava / Box with jewels slots and concave box

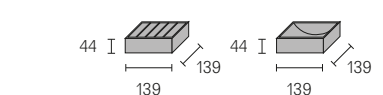





Design Giuseppe Bavuso

## Abacus

With Abacus, the walk-in closet becomes a room in synthetic leather, where extremely thin and rigorous geometric horizontal elements are placed. A project that is interpreted with a minimal style, coherent in every detail, starting from the accessories and the cabinets to organize the space, up to the led lighting system placed in the lower part of the shelves and integrated into the top part of the panels.

Con Abacus, la cabina armadio diventa una stanza di similpelle, in cui si innestano elementi orizzontali di minimo spessore e dal massimo rigore geometrico. Un progetto interpretato con uno stile minimale e coerente in ogni dettaglio, dagli accessori e i contenitori per l'organizzazione dello spazio armadio, al sistema di illuminazione a led presente nella parte inferiore delle mensole attrezzate e integrato alla sommità dei pannelli a parete.

Danke zu Abacus, kann man die Ankleide als einen Raum aus Kunstleder konzipieren, wo minimale, horizontale Elementen mit höher geometrischen Strenge sich integrieren. Einem minimaler und in jedem Details kohärenter Projekt, von Zubehören und Container, die Innenraum aufstatten, bis zum LED Beleuchtung System bei Tablaren und Spitze den Paneelen.

Avec Abacus, le dressing devient une salle de similicuir, avec des éléments horizontaux d'épaisseur minimale et de rigueur géométrique maximale. Un projet interprété avec un style minimal et cohérent dans les petits détails, des accessoires et des conteneurs pour l'organisation de l'espace nuit, au système d'éclairage à led, présent dans la partie inférieure des étagères et intégré en haut des panneaux de fond muraux.

Con Abacus, el vestidor se convierte en una estancia de similcuerro, en la que se insertan elementos horizontales de mínimo grosor y máximo rigor geométrico. Un proyecto realizado con un estilo mínimo y consistente en cada detalle, de los accesorios y contenedores para la organización del espacio armario, el sistema de iluminación LED en la parte inferior de los estantes e integrado a la parte superior de los paneles de pared.

Struttura *Structure*: 303 bronzo  
 Schienali *Panels*: 154 similpelle argilla  
 Ripiani *Shelves*: 303 bronzo  
 Portamaglioni *Pullover holder*: 07 melaminico olmo  
 Aste portabiti *Cloth-hanger rods*: acciaio inox  
 con rivestimento 154 similpelle argilla

Nella foto *In this photo*  
 Porta scorrevole  
*Sliding door*: Graphis plus  
 Sistema interparete  
*Wall partition system*: Spazio  
 Tavolino *Coffee table*: Tray



Struttura *Structure*: 303 bronzo  
 Schienali *Panels*: 154 similpelle argilla  
 Ripiani *Shelves*: 303 bronzo  
 Portamaglioni *Pullover holder*: 07 melaminico olmo  
 Aste portabiti *Cloth-hanger rods*: acciaio inox  
 con rivestimento 154 similpelle argilla

Nella foto *In this photo*  
 Porta scorrevole  
*Sliding door*: Graphis plus  
 Sistema interparete  
*Wall partition system*: Spazio  
 Tavolino *Coffee table*: Tray



Una cabina armadio che diventa sistema per arredare spazi di lavoro o commerciali come negozi o showroom: Abacus è una soluzione in continua evoluzione nella quale gli accessori e i materiali sofisticati ed eleganti, come l'esclusiva similpelle, assicurano eleganza e flessibilità in qualsiasi contesto.

A walk in wardrobe becoming a system to decorate workspaces or commercial shops and showrooms: Abacus is a always evolving solution, in which the accessories and the sophisticated and elegant materials, like the exclusive synthetic leather provide for elegance and flexibility in any context.

Ein Ankleidessystem, das Einrichtungssystem fuer Geschaeft oder Showroom sein kann: Abacus ist eine Loesung auf staendiger Entwicklung, wo exklusiven, ausgekluegelten und eleganten Zubehoeren und Materialien, wie das exclusive Kunstleder, Eleganz und Flexibilitaet in jeder Situation versichern.

Le dressing qui devient un système pour le projet des espaces de travail ou des magasins commerciaux ou des showroom: Abacus est une solution en évolution constante, dans laquelle les accessoires et les matériaux sophistiqués et élégants, comme l'exclusive similicuir, offrent élégance et flexibilité dans tout le contexte.

Un vestidor que se convierte en el sistema para amueblar espacios de trabajo o comerciales tales como tiendas y exposiciones: Abacus es una solución en continua evolución en la que los accesorios y los materiales sofisticados y elegantes, como el exclusivo simil cuero, proporcionan elegancia y flexibilidad en cualquier contexto.







## Modularità Modular structure

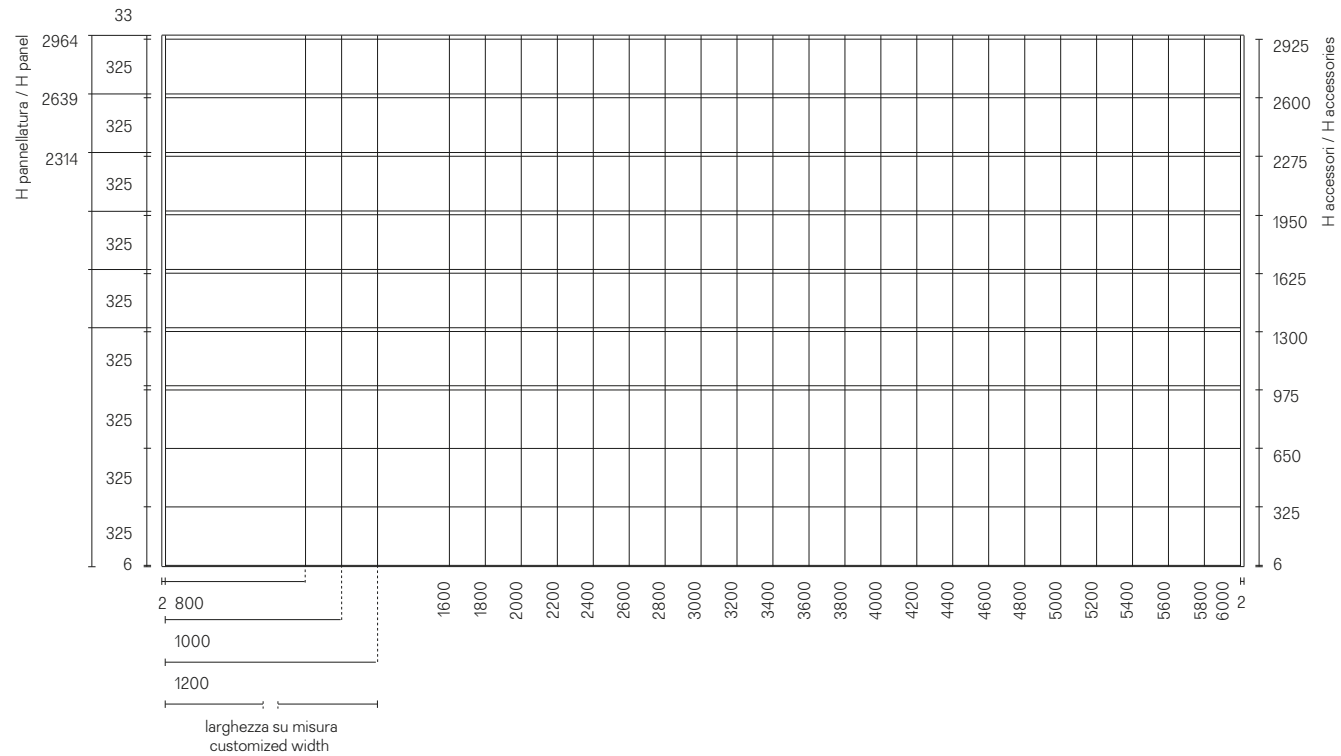

## Descrizione tecnica Technical description

La modularità del sistema Abacus si basa su pannelli a parete in vetro laccato, tessuto e similpelle disponibili in quattro larghezze e tre altezze. È inoltre previsto il taglio a misura in larghezza. Uno schema dimensionale che assicura la massima libertà progettuale, per consentire di inserire le composizioni in ogni tipo di spazio.

The modularity of the Abacus system is based on the wall panels in lacquered glass, fabric and synthetic leather available in four widths and three different heights. The custom-size cut is also provided. A dimensional plan that ensures the maximum flexibility, in order to allow to use the compositions in every type of space.

Die Modularität des Abacus Systems basiert auf den Wandpaneelen aus lackiertem Glas, Stoff und Kunstleder, die in vier Breiten und drei Höhen. Es ist auch für den Zuschnitt in der Breite zur Verfügung gestellt. Ein dimensionales Schema, das maximale Designfreiheit gewährleistet, um zu ermöglichen, die Zusammensetzung in jeder Art von Raum zu verwirklichen.

La modularité du système Abacus est basée sur des panneaux à mur en verre laqué, tissu et similicuir disponibles en quatre largeurs et trois hauteurs. Il est également prévu la découpe sur mesure en largeur. Un schéma dimensionnel qui assure un maximum de liberté de conception, afin de permettre d'insérer les compositions dans tout type d'espace.

La modularidad del sistema Abacus se basa en paneles a pared en cristal lacado, tejido y simil cuero disponibles en cuatro anchos y tres alturas. Además está previsto el corte a medida en ancho. Un esquema dimensional que asegura la máxima libertad de diseño, para permitir colocar las composiciones en todo tipo de espacio.

## Finiture Finishes



Particolare del pannello a parete in vetro laccato opaco tortora con sistema di illuminazione a led nel lato superiore, ripiano laccato opaco tortora con faretto a led integrato. Asta portabiti in acciaio inox spazzolato rivestita in similpelle argilla. / Detail of back-panel in tortora mat lacquered glass with upper led lighting system, tortora lacquered shelf with integrated led spotlight. Cloth-hanger rod in brushed stainless steel covered with argilla synthetic leather.

## Componenti Components

Pannello in vetro laccato e temperato, tessuto e similpelle, struttura in estruso di alluminio anodizzato. Profilo laterale in alluminio laccato / Panel in lacquered and tempered glass, fabric and synthetic leather, structure in extruded anodized aluminium. Lacquered aluminium side profile

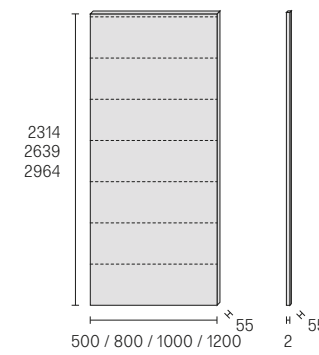

Ripiano laccato e stratificato in MDF rivestito da una doppia lastra di alluminio. Illuminazione a led opzionale / Multilayer lacquered shelf in MDF, covered by a double aluminium sheet. Optional led lighting

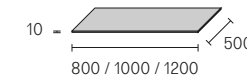

Faretto a led per ripiano laccato e illuminazione superiore a led / Led spotlight for lacquered shelves and upper led lighting

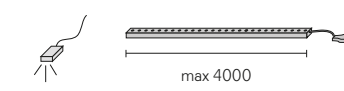

Asta portabiti in acciaio inox spazzolato con rivestimento opzionale in similpelle / Ceiling clothes-hanger rod in brushed steel (H ceiling max 3000), with optional synthetic leather finishing

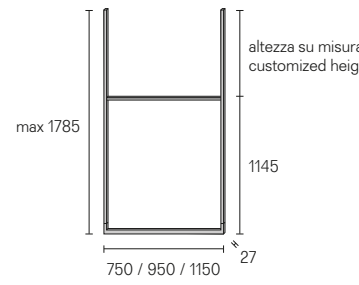

Asta portabiti per ripiano, in alluminio o in acciaio inox spazzolato, con rivestimento opzionale in similpelle / Clothes-hanger rod for shelf, in aluminium or in brushed steel, with optional synthetic leather finishing

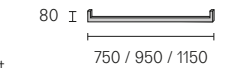

Basamento in legno tamburato con zoccolo in alluminio estruso / Floor base on feet in honeycomb wood and structure in extruded aluminium

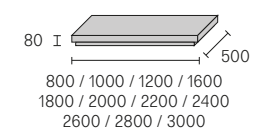

Base attrezzata con cassetto push a estrazione totale, in vetro laccato temperato con zoccolo in alluminio estruso / Floor base equipped with push drawer fitted with fully extractable runners, in tempered lacquered glass with extruded aluminium structure

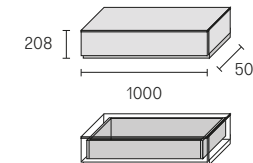

Base attrezzata per angolo con cassetto push a estrazione totale, in versione sinistra e destra, in vetro laccato temperato con zoccolo in alluminio estruso / Corner floor base equipped with push drawer fitted with fully extractable runners, left and right version, in tempered lacquered glass with extruded aluminium structure

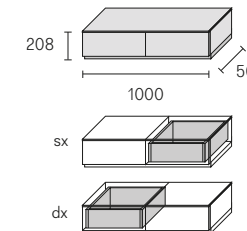

Tovaglietta opzionale in similpelle per fondo cassetti / Optional synthetic leather mat for drawer bottom

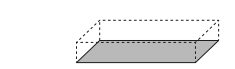

Cassettiera sospesa in vetro laccato temperato con cassetto push a estrazione totale / Suspended chest of drawers in tempered lacquered glass with push drawers fitted with fully extractable runners

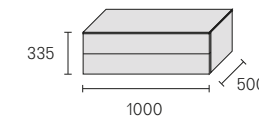

Cesta e vassoio in similpelle / Synthetic leather box and tray

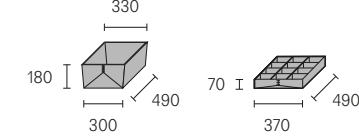

Cassettiera in vetro laccato temperato con cassetto push a estrazione totale per basamento o su ruote / Chests of drawers in tempered lacquered glass with push drawers fitted with fully extractable runners on floor base or on castors

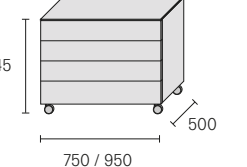
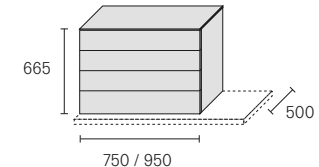

Ripiano con organizer e cesto basso estraibili con frontali in vetro e rivestimento in similpelle / Pull out shelf with organizer and small tray with glass fronts and covered with synthetic leather

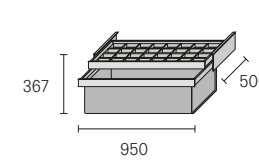
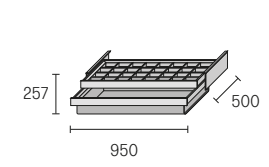

Ripiano e cesto basso estraibili con frontali in vetro e rivestimento in similpelle / Pull out shelf and small tray with glass fronts and covered with synthetic leather

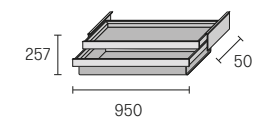

Ripiano e cesto alto estraibili con frontali in vetro e rivestimento in similpelle / Pull out shelf and small tray with glass fronts and covered with synthetic leather

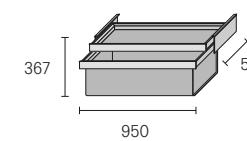

Ripiano in vetro e portapantaloni in alluminio estraibili / Pull out glass shelf and aluminium trousers rack

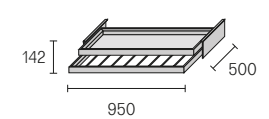

Ripiano e portapantaloni estraibili con frontali in vetro e rivestimento in similpelle / Pull out shelf and trousers rack with glass fronts and covered with synthetic leather

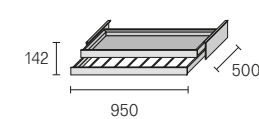

Ripiano con organizer e portapantaloni estraibili con frontali in vetro e rivestimento in similpelle / Pull out shelf with organizer and trousers rack with glass fronts and covered with synthetic leather

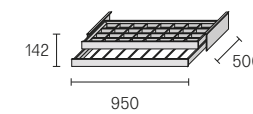

Portamaglioni / Pullover holder

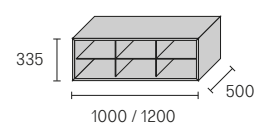
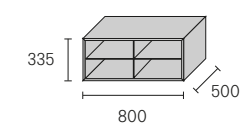

Ripiano portascarpe / Shoe rack shelf

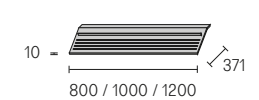

## Guida alla qualità Rimadesio Guide to Rimadesio quality

### Ecolorsystem

#### Vetri laccati lucidi e opachi Glossy and mat lacquered glasses

Ecolorsystem è la denominazione che contraddistingue l'esclusiva collezione di vetri laccati Rimadesio, disponibili in finitura lucida e opaca. Colori ecologici perché prodotti utilizzando esclusivamente vernici all'acqua di ultima generazione, con cottura a 110°C. Una tecnologia produttiva all'avanguardia nell'ambito del vetro, con impianti interni totalmente robotizzati che assicurano risultati di altissima qualità e un ciclo di lavorazione a basso impatto ambientale.

Ecolorsystem is the name that distinguishes the exclusive Rimadesio lacquered glass collection in glossy and mat finishing. Ecological colours produced, using exclusively water paints of latest generation, cooked at 110° C. Cutting edge production technology in the area of glass, with a fully robotised in-house plant that ensures very high quality results and a low environmental impact work cycle.

### Marmi Marbles

I marmi utilizzati da Rimadesio sono materiali naturali, lavorati secondo un metodo artigianale con impianti di ultima generazione e lucidati con cere naturali tendenti a rispettare l'essenza stessa del materiale. I difetti visibili sono a tutti gli effetti peculiarità del materiale stesso. La resistenza all'aggressione da parte di sostanze acide non è garantita da nessun prodotto protettivo.

All marbles used by Rimadesio are natural materials, manufactured in a handicraft way with last generation machinery and polished with natural waxes which respect the natural essence of the material itself. All visible defects are actually a peculiarity of the material. Resistance to aggression by acidic substances is not guaranteed by any protective product.

### Vetri temperati Tempered glasses

Vetri singoli, sottoposti al trattamento della tempratura ovvero ad una cottura alla temperatura di 650° C. Resistenza meccanica di 5 volte superiore rispetto ad un vetro normale. In caso di rottura si sbriciola in minuti frammenti inoffensivi. Conformi alle norme UNI EN 12150, UNI 7697 e UNI EN 12600 in materia di sicurezza per i vetri d'arredamento.

Single tempered glasses, in other words cooked at 650° C of temperature. Mechanical resistance 5 times superior in comparison to a normal glass. In case of breaking it actually crumbles in harmless tiny fragments. In accordance with the UNI EN 12150, UNI 7697 and UNI EN 12600 rules with reference to the security of glasses for decoration purposes.

### Cuoio Leather

Vero cuoio bovino naturale, ricavato tramite processo di concia. La superficie viene verniciata per ottenere le varie colorazioni a catalogo.

Real bovine natural leather obtained by a process of tanning. The surface is polished to obtain the different colours of the collection.

### Vetri stratificati Laminated glasses

Vetri doppi. Fra i due vetri è inserita una sottile pellicola di materiale plastico, trasparente ed invisibile, che aderisce completamente alle due superfici. Entrambe le superfici sono perfettamente lisce. Resistenza alla rottura conforme alle norme UNI EN ISO 12543, UNI 7697 e UNI EN 12600. La pellicola di materiale plastico in caso di rottura trattiene i frammenti.

Double glasses. Between the two glasses a thin plastic film is inserted. Transparent and invisible it perfectly sticks to both surfaces. Both surfaces are perfectly smooth. Resistance to breaking in accordance with the UNI EN ISO 12543, UNI 7697 and UNI EN 12600 rules. The plastic film withholds the fragments in case of breaking.

### Similpelle Synthetic leather

Materiale in fibra sintetica di ultima generazione realizzato interamente in Italia e privo di componenti di origine animale. Un prodotto esclusivo Rimadesio, disponibile in quattro finiture - castoro, argilla, nube e rubens. Resistente e altamente performante, è privo di orto-ftalati, in linea con il regolamento europeo Reach per la protezione della salute e dell'ambiente dai rischi delle sostanze chimiche. Ogni fase di produzione della similpelle Rimadesio è conforme alle normative vigenti in materia ambientale e di gestione della qualità.

Latest generation synthetic material entirely produced in Italy and animal-derived components free. Available in four finishes - castor, argilla, nube and rubens - it is an exclusive by Rimadesio. Resistant and high performing, it is also ortho-phthalates free, in accordance with the European Reach regulation for the protection of human health and the environment from the risks of chemical substances. The production system of Rimadesio synthetic leather complies with current environmental and quality standards.

### Ecolorsystem Elementi strutturali laccati Lacquered structural elements

Ecolorsystem è la denominazione che contraddistingue l'esclusiva collezione di laccature opache Rimadesio, realizzate su componenti metallici, in legno e plastici. Colori ecologici perché prodotti utilizzando esclusivamente vernici all'acqua di ultima generazione, con cottura a 70°. Una tecnologia produttiva all'avanguardia, con impianti interni robotizzati che assicurano risultati di altissima qualità e un ciclo di lavorazione a basso impatto ambientale.

Ecolorsystem is the name that distinguishes the exclusive Rimadesio lacquering collection in mat finishing, realized on metallic, wooden and plastic components. Ecological colours produced using exclusively water paints of latest technology, cooked at 70° C. A modern production technology, with fully robotised in-house plants that ensures very high quality results and a low environmental impact work cycle.

### Tessuto material Material fabric

Tessuto prodotto artigianalmente in Italia, composto da: viscosa 43%, cotone 36%, poliestere 15%, lino 6%. Resistenza all'abrasione, test Martindale 25.000 giri. Resistenza al pilling, classe 4. Resistenza allo scolorimento, Xenotest classe 5. Conforme alla normativa BS5852 part 0 cigarettes test.

Italian handcrafted fabric made of: viscose 43%, cotton 36%, polyester 15%, linen 6%. Resistance to scraping, Martindale test 25.000 twists. Resistance to piling, class 4. Resistance to discolouration, Xenotest class 5. Conforms to BS 5852 part 0 cigarettes test.

### Tessuto Lux Lux fabric

Tessuto prodotto artigianalmente in Italia, composto da: cotone 75%, seta 25%.

Italian handcrafted fabric made of: cotton 75%, silk 25%.

### Essenze Woods

Gli elementi impiallacciati, come piani, contenitori e ripiani, sono realizzati utilizzando tranciato conforme alle normative riguardanti le emissioni di formaldeide. Verniciatura a poro aperto con fondo e finitura acrilica atossica opaca trasparente.

Veneered elements, such as tops, cabinets and shelves, are produced by using materials in compliance with current regulations concerning the emissions of formaldehyde. Open pore painting with primer and non-toxic mat transparent acrylic finish.

### Gres

Il gres porcellanato è un materiale ceramico a pasta compatta, dura, colorata e non porosa, ottenuto partendo da impasti di argille, sabbia ed altre sostanze naturali cotti a temperatura elevata (1000-1300 C°). L'esclusiva trama è realizzata con le più innovative tecniche di stampaggio con inchiostri e smalti all'acqua, ecologici e sostenibili. Elevata resistenza all'abrasione.

Gres is a compact, hard, colored and non-porous ceramic material, obtained through a mixture of clays, sand and other natural substances, that cooked at a high temperature (1000-1300 C°). The exclusive controlled intensity variation weave, created with the most innovative molding techniques with water-based ecological and sustainable inks and enamels. High resistance to abrasion.

## Vetri Glasses

	Ecolorsystem laccati lucidi glossy lacquered	Ecolorsystem laccati opachi mat lacquered	Ecolorsystem reflex	Trasparenti Transparent	Satinati Satinated	Neutri Neutral	Vetri rete Rete glasses
--	--	---	------------------------	----------------------------	-----------------------	-------------------	----------------------------

### Wall paneling system

Modular	●	●	●			●	
---------	---	---	---	--	--	---	--

### Wall partition system

Spazio				●	●		●
--------	--	--	--	---	---	--	---

### Sliding doors

Daimon				●			
Soho	●	●	●	●	●	●	●
Stripe	●	●	●	●	●	●	●
Sail	●	●	●	●	●	●	●
Velaria	●	●	●	●	●	●	●
Graphis plus/light	●	●	●	●	●	●	
Siparium	●			●	●	●	

### Doors

Zen, Zen Frame	●	●	●	●	●	●	●
Moon	●	●	●	●	●	●	
Vela	●	●	●	●	●	●	●
Luxor	●	●	●	●	●	●	
Even	●			●	●	●	
Aura	●	●	●			●	
Spin	●			●	●	●	●
Link+	●	●	●			●	
Sail	●	●	●	●	●	●	●

### Storage system

Cover	●	●	●	●	●	●	
Cover freestanding	●	●	●	●	●	●	

### Day collection

Zenit	●	●		●	●		●
Opus	●	●	●	●	●		
Wind	●	●	●	●	●	●	●
Alambra	●	●	●	●	●	●	
Self	●	●	●	●	●	●	
Self bold	●	●	●	●	●	●	
Self up	●	●	●	●	●	●	
Abacus living	●	●		●	●		

### Complements

Long Island	●	●		●			
Manta	●	●		●			
Flat	●	●					
Planet	●	●		●			
Tray	●	●					
Sixty coffee table	●	●					
Sixty	●	●					
Ala		●		●			
Dolmen	●			●			
Eos	●	●					

### Night collection

Dress bold	●	●	●		●	●	
Zenit	●	●		●	●		
Abacus	●	●			●		

Per conoscere le finiture disponibili per ogni singolo prodotto, effettuare il download catalogo nella sezione prodotti del sito rimadesio.it  
In order to know the finishes available for each product, download the catalog in the product section of the website

Finishings



Vetri laccati Ecolorsystem  
Ecolorsystem lacquered glasses

Lucidi Opachi Glossy Mat			Lucidi Opachi Glossy Mat			Lucidi Opachi Glossy Mat			Lucidi Opachi Glossy Mat			Lucidi Opachi Glossy Mat		
40	115	Grigio cenere	53	95	Bianco neve	45	97	Avorio	50	108	Bianco latte	76	116	Rosso india
	121	Azzurro cera	59	105	Grigio chiaro	304	137	Platino	78	114	Sabbia	75	129	Amaranto
35	100	Blu notte	56	98	Lino	85	130	Tufo	74	110	Canapa	84	128	Moro
86	131	Blu oceano	41	104	Grigio ombra	69	126	Palladio	51	113	Nocciola	300	133	Rame
47	96	Grigio perla	88	132	Grigio scuro	57	106	Tortora	52	107	Corda	301	134	Peltro
36	117	Blu Londra	48	103	Grigio ardesia	58	99	Caffè	73	109	Giallo kashmir	83	127	Piombo
	122	Verde inglese				46	102	Nero	43	119	Laguna	302	135	Grafite
									33	111	Verde oliva	303	136	Bronzo

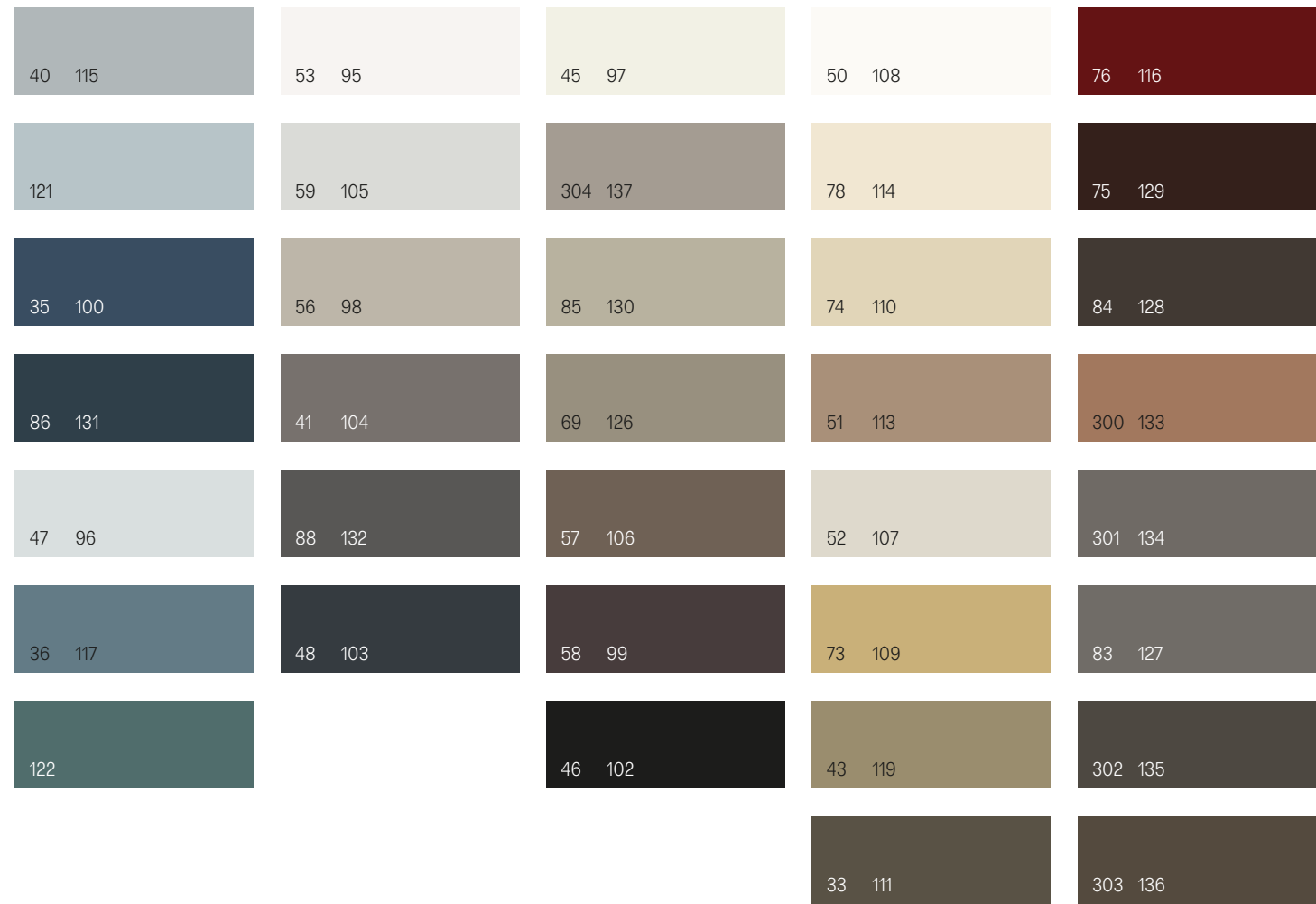

Vetri reflex Ecolorsystem  
Ecolorsystem reflex glasses

90	Bianco reflex
92	Kaki reflex
94	Cacao reflex
89	Nero reflex

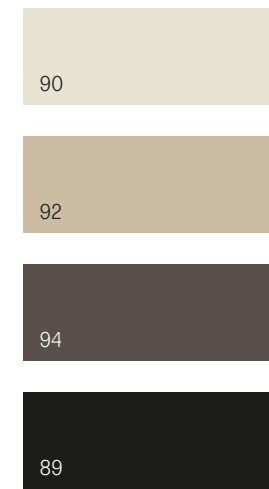

Vetri trasparenti  
Transparent glasses

05	Trasparente extrachiaro
00	Trasparente
63	Grigio trasparente
65	Bronzo trasparente
67	Riflettente chiaro
64	Riflettente grigio
81	Riflettente bronzo

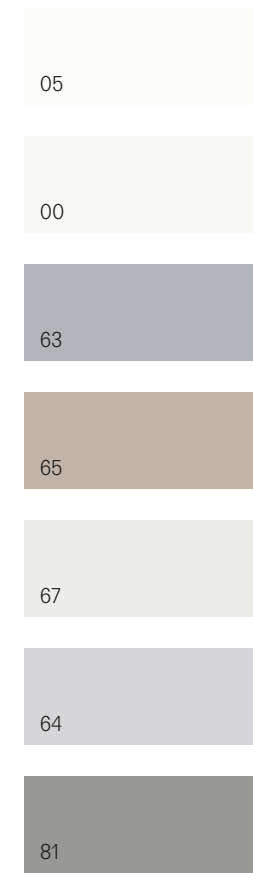

Vetri rete  
Rete glasses

60	Rete alluminio
61	Rete inox
62	Rete bronzo
66	Maglia gold
87	Maglia rame

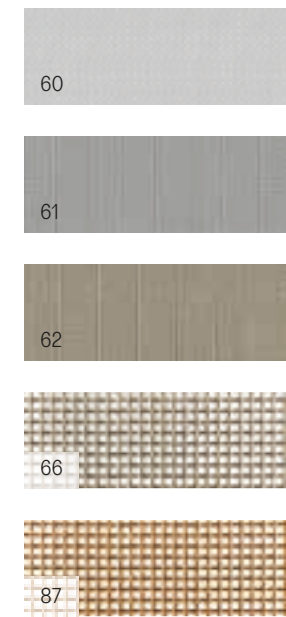

Vetri satinati  
Satinated glasses

01	Acidato
02	Acidato extrachiaro
80	Nuvola
82	Nuvola extrachiaro
03	Acidato grigio
04	Acidato bronzo

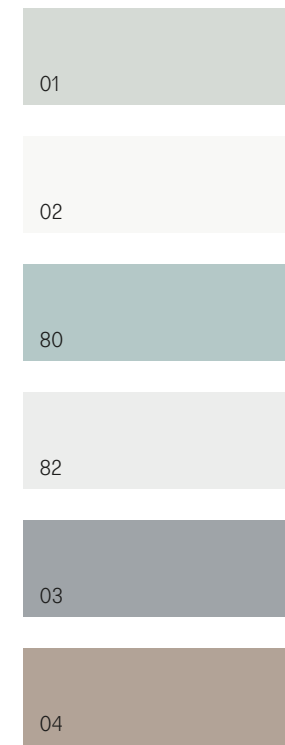

Vetri neutri  
Neutral glasses

55	Specchio
68	Specchio grigio



Elementi strutturali  
Structural elements

	30 alluminio	31 alluminio lucido	13 nero	14 brown	16 bianco latte	18 nickel nero	Ecoloursystem laccato opaco mat lacquered	Metallo graffiato Scraped metal	22 nero lucido
<b>Wall paneling system</b>									
Modulor			•	•	•		•		
<b>Wall partition system</b>									
Spazio	•		•	•	•		•		
<b>Sliding doors</b>									
Daimon			•	•					
Soho			•	•	•		•		
Stripe			•	•					
Sail			•	•			• <sup>8</sup>		
Velaria	•		•	•	•		•	•	
Graphis plus/light	•		•	•	•		•		
Siparium	•		•	•	•		•		
<b>Doors</b>									
Zen, Zen Frame	•		•	•	•		•		
Moon	•	• <sup>1</sup>	•	•	•		•		
Vela	•		•	•	•		•		
Luxor	•	• <sup>1</sup>	•	•	•		•		
Even			•	•					
Aura	•		•	•	•		•		
Spin	•		•	•	•		•		
Link+	•		•	•	•		•		
Sail			•	•	• <sup>9</sup>		• <sup>9</sup>		
<b>Storage system</b>									
Cover	•		•	•			• <sup>3</sup>		
Cover freestanding	•		•	•			• <sup>3</sup>		
<b>Day collection</b>									
Zenit	•		•	•			• <sup>7</sup>	•	
Opus			•	•	•				
Wind			•	•	•		•	•	
Alambra			•	•			• <sup>4</sup>		
Self	•		•	•	•		•		
Self bold	•		•	•	•		•	•	
Self up	•		•	•	•		•		
Abacus living	•		•	•	•		•		
<b>Complements</b>									
Long Island		•	•	•	•	•	•	•	•
Manta		•	•	•	•	•	•	•	•
Flat	•		•	•	•		•	•	
Planet		•	•	•	•	•	•	•	•
Tray		•	•	•	•	•	•	•	•
Sixty coffee table	•		•	•	•		•	•	
Sixty	•		•	•	•		•	•	
Ala							• <sup>5</sup>		
Dolmen	•		•	•	•		•		
Eos			•	•	•		•		
<b>Night collection</b>									
Dress bold	•			•			• <sup>6</sup>		
Zenit	•		•	•			• <sup>2</sup>		
Abacus	•		•	•	•		•		

<sup>1</sup> Solo per porta in cuoio / only for leather door  
<sup>2</sup> Solo per / only for 83 piombo, 303 bronzo  
<sup>3</sup> Solo per / only for 304 platino, 83 piombo, 303 bronzo  
<sup>4</sup> Solo per / only for 304 platino, 303 bronzo

<sup>5</sup> Solo per / only for 303 bronzo  
<sup>6</sup> Solo per / only for 303 bronzo, 83 piombo  
<sup>7</sup> Solo per / only for 303 bronzo, 69 palladio, 303 platino, 303 bronzo

<sup>8</sup> Solo in / only in bronzo, piombo e grafite  
<sup>9</sup> Pannello / panel in bronzo, piombo e grafite.  
 Stipite e maniglia in tutti i colori / jamb and handle in all colors

Elementi strutturali  
Structural elements

	25 melaminico larice carbone	09 melaminico rovere grigio	07 melaminico olmo	19 rovere termotrattato	27 rovere nero	15 noce	Marmo Marble	Similpelle Synthetic leather	Cuoio Leather	17 noce sahara 20 rovere termotrattato sahara	Tessuto Fabric	Gres
<b>Wall paneling system</b>												
Modulor								•		•	•	•
<b>Wall partition system</b>												
Spazio												
<b>Sliding doors</b>												
Daimon												
Soho				•		•						
Stripe												
Sail				•		•						
Velaria												
Graphis plus/light								•				•
Siparium												
<b>Doors</b>												
Zen, Zen Frame												
Moon				•		•		•	•	•		•
Vela												
Luxor				•		•		•	•	•		•
Even												
Aura				•		•		•		•		•
Spin												
Link+				•		•		•		•		•
Sail				•		•						
<b>Storage system</b>												
Cover	•	•						•			•	•
Cover freestanding	•	•						•			•	•
<b>Day collection</b>												
Zenit												
Opus												
Wind												
Alambra				•	•	•		•				
Self				•		•		•				•
Self bold				•		•		•	•			•
Self up				•		•		•				•
Abacus living				•		•						•
<b>Complements</b>												
Long Island				•	•	•		•		•		
Manta				•	•	•		•		•		
Flat				•	•	•						
Planet									•			
Tray									•			
Sixty coffee table										•		
Sixty										•		
Ala										•		
Dolmen										•		
Eos												•
<b>Night collection</b>												
Dress bold	•	•	•					•			•	
Zenit	•	•	•					•				
Abacus				•				•			•	

Laccato opaco Ecolorsystem  
Ecolorsystem mat lacquered



Tessuto material  
Material fabric

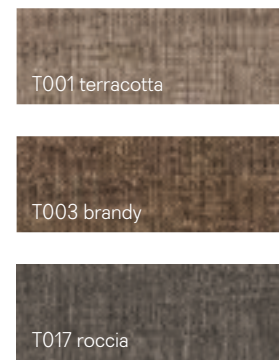

Tessuto lux  
Lux fabric

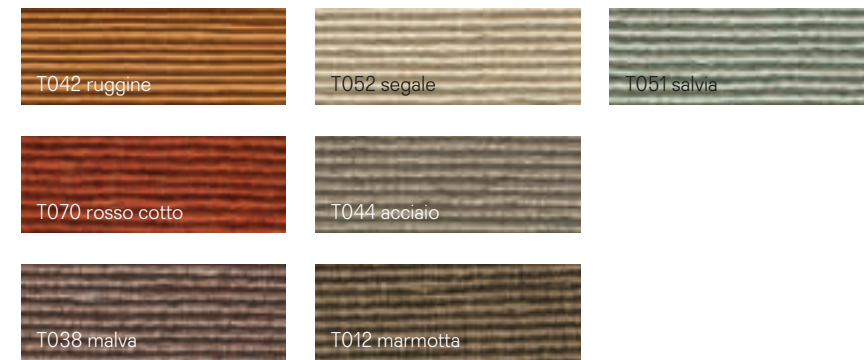

Alluminio  
Aluminium

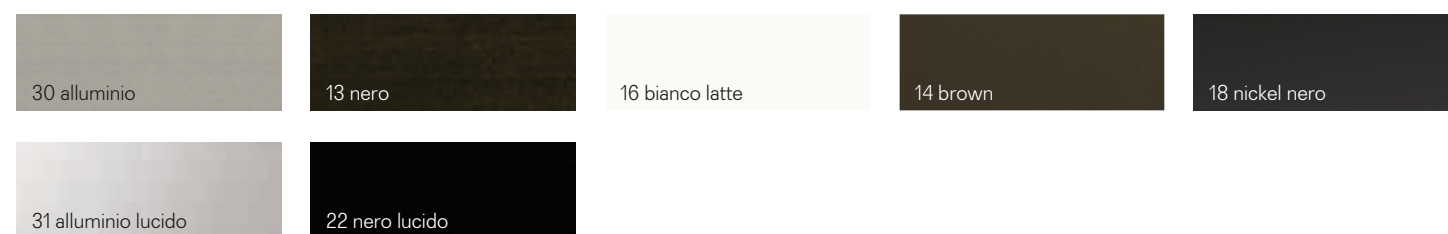

Metallo graffiato  
Scraped metal



Essenza e melaminico  
Wood and melamine



Marmo  
Marble

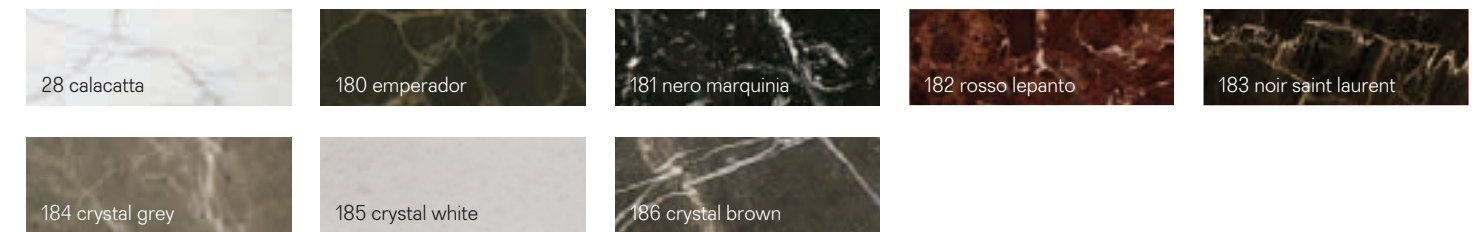

Gres

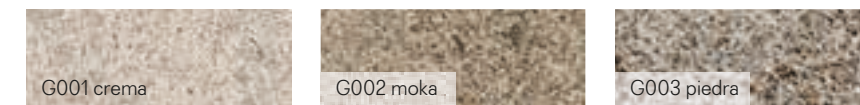

Cuoio  
Leather

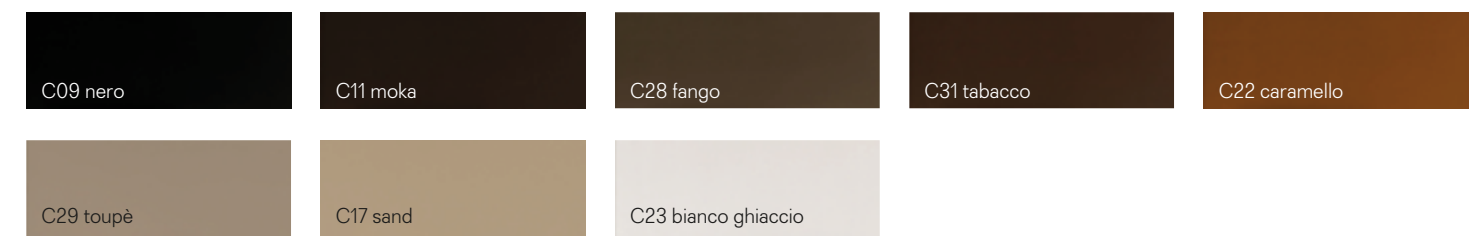

Similpelle  
Syntetic leather

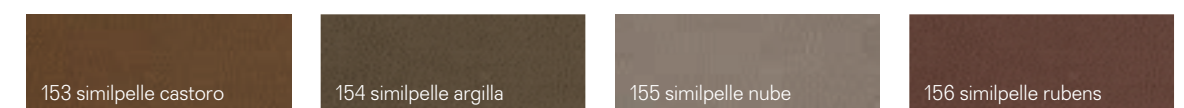

Collection designed by Giuseppe Bavuso

Art direction: Paolo Mojoli  
Graphic project: Juma  
Photo: Santi Caleca, Federico Cedrone  
Technical photo: F2 Fotografia  
Styling: Studiopepe, Patrizia Cantarella with Rossella Ballabio,  
Martina Lucatelli with Martina Dalla Bona  
Render: Alessandro Consonni  
Stage setup: Ottonove  
Films and print: Optima  
Printed in Italy / January 2020

Thanks to: Agapecasa, Amini Carpets, Arper, Artemide, Astep, Aytm, Azucena, B&B Italia, Bang and Olufsen, Belux ag, Camp Design Gallery, Carl Hansen & Søn, Ciclotte, Clio Calvi Rudy Volpi Gallery, Confalonieri, Dany Gilles, De Vecchi Milano 1935, Dep Art Gallery, Fantini, Flexform, Flos, FontanaArte, Fritz Hansen, Georg Jensen, Henry Timi, Ivano Redaelli, J. & L. Lobmeyr, Kasthall, Living Divani, Louis Poulsen, Louverdrape Italia, Matteo Thun Atelier, Maxalto, Minotti, MMairo, Monteverro, Muji, Noorth | milldue edition, Nude, Numa Limited Editions, Officine Saffi, Oluce, Pallucco, Pandul-Classico, Modern Lights, Pineider, Pinetti, Produzione Privata, R-Store Apple Premium Reseller, Rimowa store Milano, Riva 1920, San Lorenzo, Santa & Cole, Society Limonta, Stefano Casciani con Gabi Faeh Edition, Stelton, Totto, Vesoi, Vistosi, Vitra, When Objects Work.



Rimadesio spa  
Via Furlanelli 96  
20833 Giussano (Mb) Italy  
T +39 0362 3171  
F +39 0362 317317  
www.rimadesio.it  
rimadesio@rimadesio.it

Milano Flagship store  
via Visconti di Modrone 26  
20122 Milano Italy  
T-F +39 02 76280708  
milano@rimadesio.it

London Flagship store  
83, Wigmore street  
1WU 1DL London  
T +44 2074 862193  
london@rimadesio.co.uk

Italy showroom:  
Milano, Roma, Genova, Torino, Como, Brescia, Parma, Firenze, Palermo,  
Catania, Cosenza, Salerno.

Worldwide showroom:  
Genève, Wien, Hamburg, Munich, Nice, Madrid, Barcelona, Bilbao, Marbella, Valencia,  
Vigo, Bruxelles, Moscow, Saint Petersburg, Istanbul, Kiev, Beirut, Tokyo, Seoul,  
Shanghai, Beijing, Hangzhou, Hong Kong, Singapore, Manila, Hyderabad, New Delhi,  
Bangalore, Denver, New York, Miami, Mexico City, Santiago del Chile, Bogotá,  
Cape Town, Casablanca, Sydney.

Follow us on Facebook, Instagram

#### Awards

1993	Siparium	Young & Design 1993
2000	Zenit	Award KBB
2001	Zenit	selezione Design Index ADI 2001
2002	Siparium	Top100 Frames
2005	Graphis	selezione Design Index ADI 2005
2007	Vela	selezione Design Index ADI 2007
2008	Vela	segnalazione XXI Premio Compasso d'Oro ADI
2015	Wind	winner Red Dot Award 2015
2016	Cover	AZ awards 2016 Best Furniture System
2016	Alambra	selezione Design Index ADI 2016
2017	Sail	selezione Design Index ADI 2017
2017	Soho	AZ awards 2017 Architectural products
2017	Daimon	Interior Design Magazine Best of Year awards

2013 **ADIMEMBER**

#### Modelli depositati e brevettati / Patented:

Sail, Soho, Velaria, Stripe, Daimon, Graphis, Siparium, Zen,  
Zen frame, Moon, Vela, Luxor, Even, Aura, Spin, Link+, Planet, Flat,  
Alambra, Abacus living, Self, Cover, Zenit, Dress bold e Abacus.

#### Marchi registrati / Registered trademarks:

Rimadesio, Ecoloursystem, Siparium, Velaria, Abacus.

